

# EM13x Series

## SMART MULTIFUNCTION METER

### Installation and Operation Manual

---



## LIMITED WARRANTY

The manufacturer offers the customer a 24-month functional warranty on the instrument for faulty workmanship or parts from date of dispatch from the distributor. In all cases, this warranty is valid for 36 months from the date of production. This warranty is on a return to factory basis.

The manufacturer does not accept liability for any damage caused by instrument malfunction. The manufacturer accepts no responsibility for the suitability of the instrument to the application for which it was purchased.

Failure to install, set up or operate the instrument according to the instructions herein will void the warranty.

Only a duly authorized representative of the manufacturer may open your instrument. The unit should only be opened in a fully anti-static environment. Failure to do so may damage the electronic components and will void the warranty.

The greatest care has been taken to manufacture and calibrate your instrument. However, these instructions do not cover all possible contingencies that may arise during installation, operation or maintenance, and all details and variations of this equipment are not covered by these instructions.

If the equipment is used in a manner not specified by SATEC LTD, the protection provided by the equipment may be impaired.

For additional information regarding installation, operation or maintenance of this instrument, contact the manufacturer or your local representative or distributor.

All trademarks are property of their respective owners.

Copyright 2007-2018 © SATEC LTD.



# WARNING

**Read the instructions in this manual before performing installation and take note of the following precautions:**

1. Ensure that all incoming AC power and other power sources are turned OFF before performing any work on the instrument. Protect the measurement AC Inputs voltage (V1, V2, V3) with 2A external overcurrent protection device and the power supply source inputs with 5A external overcurrent protection device, located close to the equipment.
2. Before connecting the instrument to the power source, check the labels on the back of the instrument to ensure that your instrument is equipped with the appropriate power supply voltage, input voltages and currents. Failure to do so may result in serious or even fatal injury and/or equipment damage.
3. Under no circumstances should the instrument be connected to a power source if it is damaged.
4. To prevent potential fire or shock hazard, do not expose the instrument to rain or moisture.
5. The secondary of an external current transformer must never be allowed to be open circuit when the primary is energized. An open circuit can cause high voltages, possibly resulting in equipment damage, fire and even serious or fatal injury. Ensure that the current transformer wiring is secured using an external strain relief to reduce mechanical strain on the screw terminals, if necessary.
6. Only qualified personnel familiar with the instrument and its associated electrical equipment must perform setup procedures.
7. Do not open the instrument under any circumstances when it is connected to a power source.
8. Do not use the instrument for primary protection functions where failure of the device can cause fire, injury or death. The instrument can only be used for secondary protection if needed.

**Read this manual thoroughly before connecting the device to the current carrying circuits. During operation of the device, hazardous voltages are present on input terminals. Failure to observe precautions can result in serious or even fatal injury or damage to equipment.**

**This equipment does not require cleaning for proper operation**

# Quick Start Guide

This section can be used by a licensed electrician to install and perform basic EM13X setup. For more detailed EM13X Series setup and use instructions, see the following chapters in this manual.

This quick start guide will assist you to have the unit running for the first time.

During the operation of the meter, hazardous voltages are present in the input terminals. Failure to observe precautions can result in serious or even fatal injury or damage to equipment.

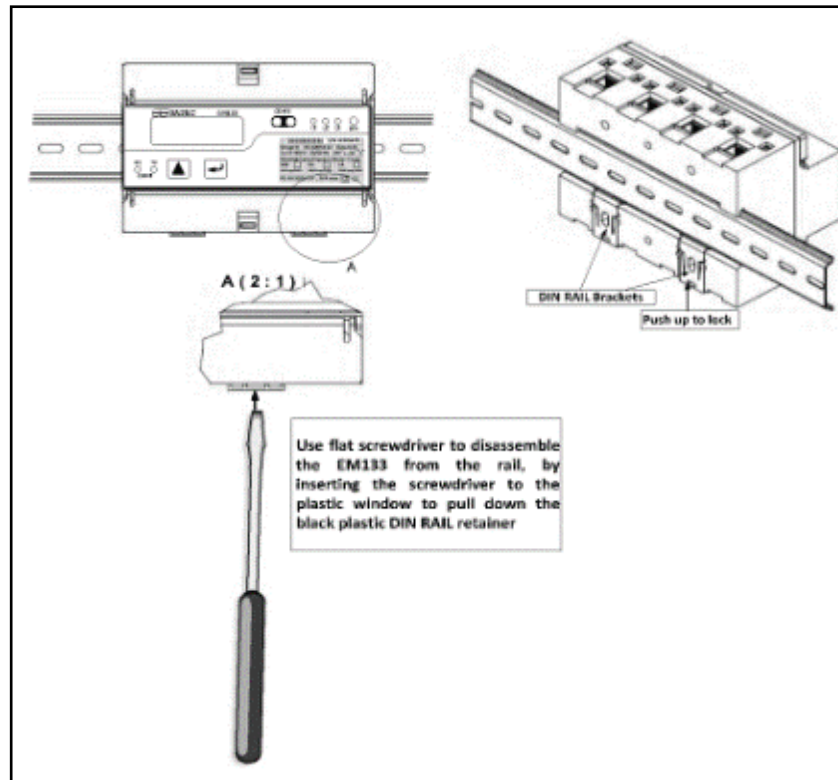
For complete and accurate in-depth instructions, refer to the following chapters in this manual.

## Installing the EM13X SERIES

### Mounting the EM13X SERIES Unit

**To mount the EM13X SERIES on Din rail:**

- Hang the EM13X Series unit on the DIN Rail by positioning the upper side first then lower side.
- Push up the DIN rail brackets to lock the EM13X Series on the rail.



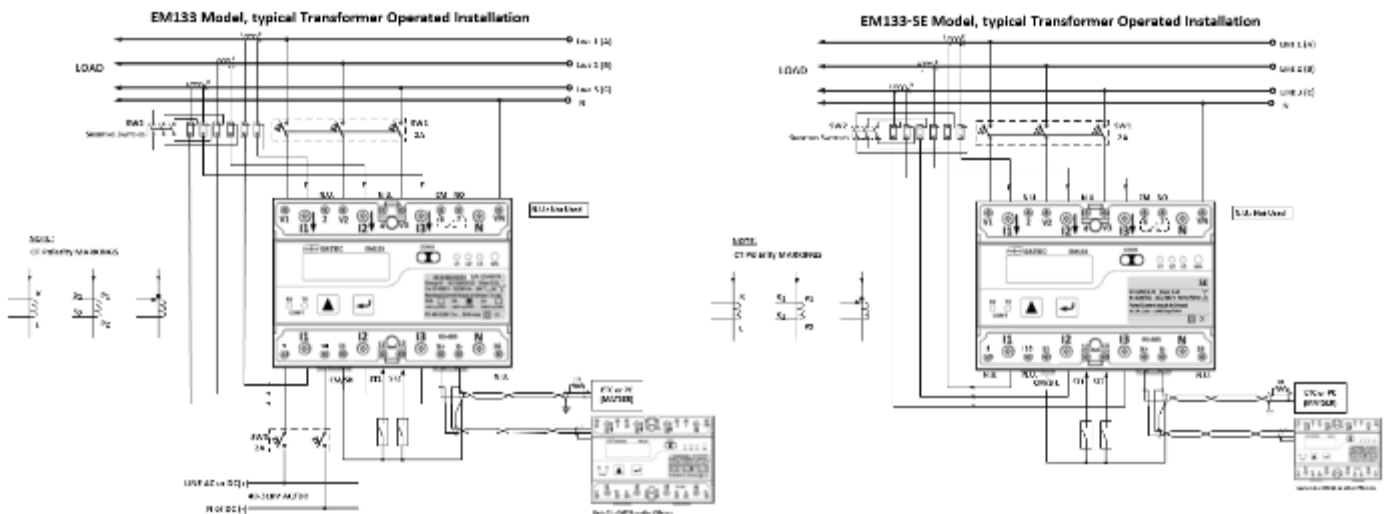
**Mounting the EM13X Series on DIN-Rail**

## To mount the EM13X Series on flat surface:

- Locate the EM13X Series on the surface to
- Push up the DIN rail brackets to lock the EM13X Series on the rail.

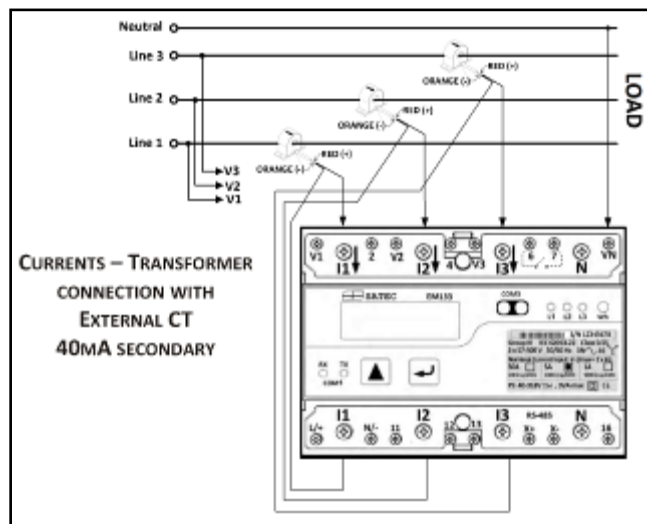
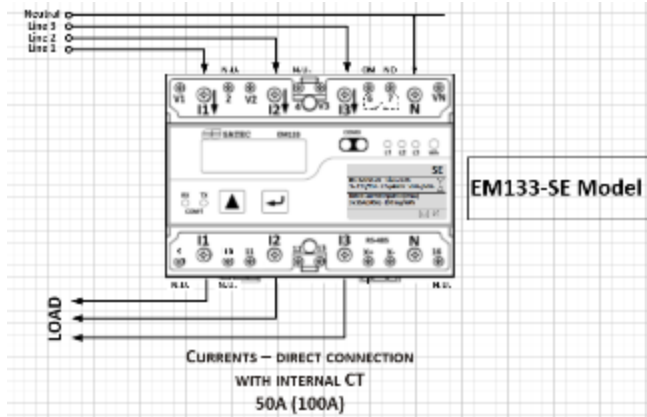
## Connecting the EM13X Series Unit

- Ensure that all incoming power sources are OFF.
- Check that you have the appropriate power supply.
- For direct connection, connect to CT wires through the meter CT terminals. Observe the arrow that indicates the current direction.
- In case of a retrofit application or high current external SATEC CT (or Split Core) where each external CT ends with two wires:
  - Connect the wire to the meter current termination screws.
- Connect the measured voltage inputs
- Connect COM1 – RS-485 communication port
- In case of EM132/133 model with Aux. Power supply connect the Power Supply inputs using 1.5 mm<sup>2</sup>/14AWG-dedicated wires.



### Common Wiring Mode: EM13x and EM13x-SE 4LL3 or 4Ln3

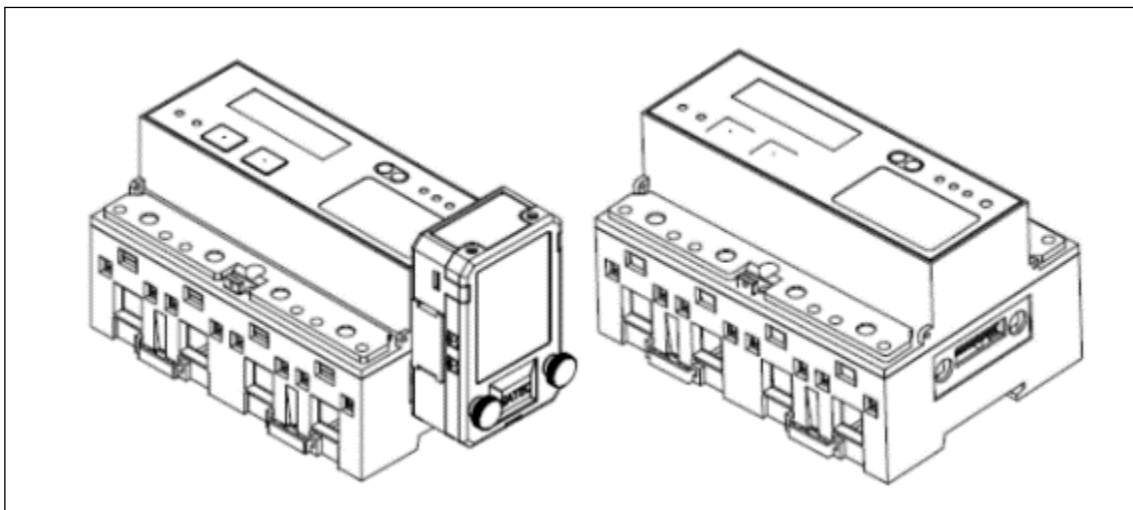
#### EM13x-SE: Self Energized Meter model



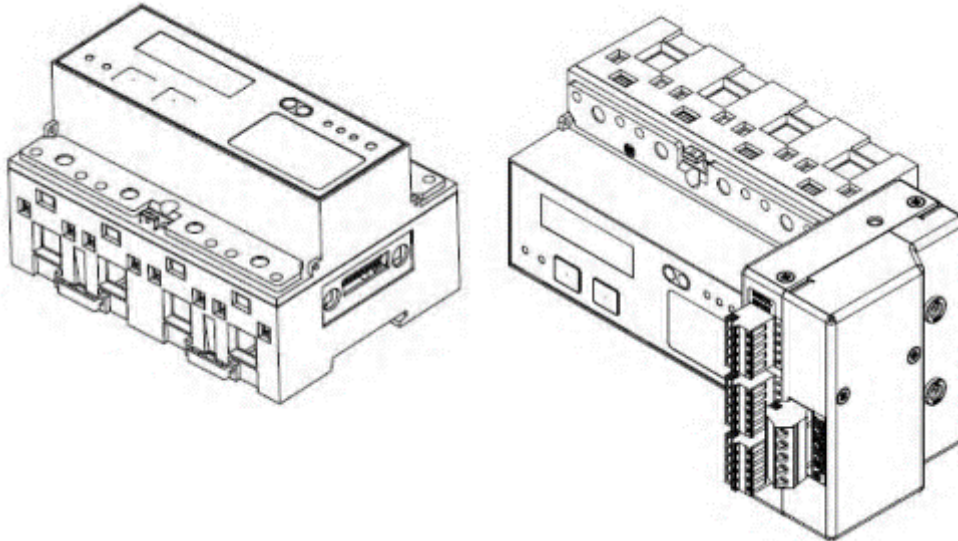
CT wiring

**To connect an Option module:**

- Assemble the module on the meter.
- Power the EM13X Series unit on.



Assembly a small module



**Assembling the 12DI/4RO module**

**To operate the EM13X Series:**

- Perform device diagnostics.
- Configure the device through the EM13X Series unit front panel display

**Configuring the EM13X Series remotely**

- Install the PAS application software on your PC.
- Configure the PAS database for your meter.
- Configure the PAS communications settings.
- Upgrade the meter firmware if a new version is available.
- Set up the meter using the PAS application software.
- Configure your security settings through the meter security setup.
- Configure your communication protocol settings.
- Configure Billing/TOU registers.

At this stage, the EM13X Series should be ready for operation.

# Table of Contents

---

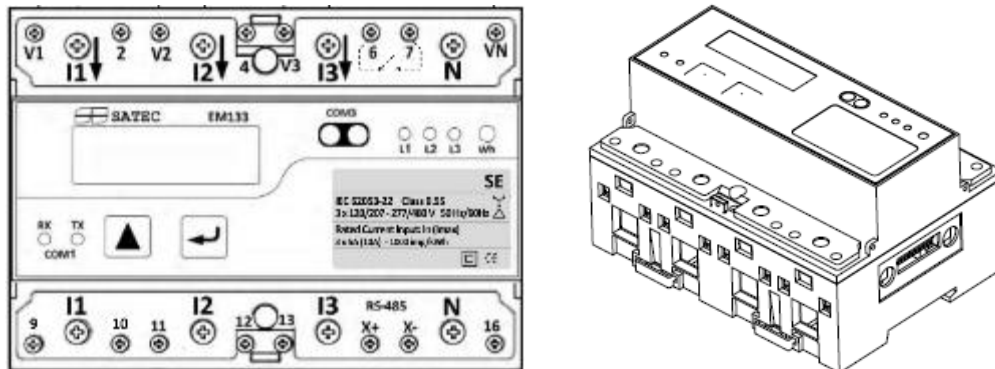
<b>Chapter 1 General Information .....</b>	<b>11</b>
<b>1.1 Features.....</b>	<b>13</b>
<b>1.2 Available Options.....</b>	<b>14</b>
Digital I/O .....	15
Analog Output .....	15
Additional Communication Port- COM2.....	15
<b>1.3 Customized Options .....</b>	<b>16</b>
Device Resolution.....	16
Display Options.....	16
<b>1.4 Measured Parameters .....</b>	<b>16</b>
<b>1.5 Labelling .....</b>	<b>18</b>
<b>Chapter 2 Installation .....</b>	<b>19</b>
<b>2.1 Site Requirements .....</b>	<b>19</b>
<b>2.2 Package Contents.....</b>	<b>19</b>
<b>2.3 Mechanical Installation.....</b>	<b>19</b>
Wall Mounting.....	21
DIN Rail Mounting .....	22
Add-On Module Mounting.....	23
<b>2.4 Electrical Installation.....</b>	<b>23</b>
Connecting the wires .....	24
Typical Installation .....	25
Terminals.....	30
Power Source Connection.....	31
Voltage Input connection .....	33
Current Input Connection.....	34
Wiring Diagrams .....	35
<b>2.5 Battery Replacement .....</b>	<b>42</b>
<b>2.6 I/O Connections .....</b>	<b>43</b>
2DI/1RO Standard .....	43
4DI/2RO Module .....	44
8 DI module .....	45
12DI/4RO Module .....	45
4AO Module - Analog Outputs.....	46
2G/3G+2 AI Module – 2 x Analog Inputs .....	48
<b>2.7 Communications Connections.....</b>	<b>49</b>
RS-485 Connection .....	50
ETH module – COM2 Ethernet Connection.....	51
PRO module – COM2 PROFIBUS Connection.....	53
CANopen module – COM2 CANopen Connection .....	53
RS-232/422-485 module – COM2 Connection .....	54
Connecting a Cellular module .....	55
Connecting an RF module .....	57
Connecting a WiFi module.....	57
<b>Chapter 3 Using Front Display .....</b>	<b>58</b>
Energy Pulse LED.....	58
COMPort Activity LEDs .....	58
VOLTAGES LEDs .....	58
Navigation Buttons.....	58



<b>3.1 Display Operations .....</b>	<b>59</b>
Navigation Buttons.....	59
Navigating in Data Display Mode.....	60
Display Features .....	60
Measurement Units .....	61
<b>3.2 Data Displays.....</b>	<b>61</b>
TEST Mode Data Display .....	61
Billing Period Energy Data Displays .....	61
TOU/Maximum Demand Power Data Display .....	63
Instrumentation Measurement Maximum Demand Data Display .....	65
Instrumentation Measurement.....	66
Status Inputs and Outputs .....	68
Device Info Display .....	69
<b>3.3 Programming Mode .....</b>	<b>71</b>
Navigation Buttons.....	71
Entering Numeric Values.....	71
Password Security.....	71
Setup Menus and Access Rights.....	71
Viewing and Changing Setup Options .....	73
<b>Chapter 4 Using PAS Software .....</b>	<b>74</b>
<b>4.1 Installing PAS.....</b>	<b>74</b>
<b>4.2 Creating a New Site for your Meter .....</b>	<b>74</b>
<b>Chapter 5 Configuring the EM13X Series.....</b>	<b>76</b>
<b>5.1 Configuring Communications.....</b>	<b>76</b>
Setting Up Serial Communication Ports.....	76
Setting up the Ethernet.....	78
Setting up GPRS Network .....	79
Setting Up WiFi Network .....	80
Setting Up eXpertPower Client.....	85
Setting Up TCP Notification Client.....	86
<b>5.2 General Meter Setup .....</b>	<b>87</b>
Basic Meter Setup .....	87
Device Options .....	91
Configuring Digital Inputs.....	92
Configuring Relay Outputs.....	94
Configuring Analog Outputs.....	97
Configuring Counters.....	99
Configuring Alarm/Control Setpoints.....	101
Configuring the Display .....	104
Local Time Settings .....	106
<b>5.3 Configuring Meter Security .....</b>	<b>108</b>
<b>5.4 Configuring Billing/TOU .....</b>	<b>110</b>
Configuring Billing/Tariff Registers.....	110
Configuring the Daily Tariff Schedule .....	112
Configuring the Season Tariff Schedule.....	113
<b>5.5 Configuring Recorders .....</b>	<b>114</b>
Configuring Meter Memory .....	114
Configuring the Event Recorder .....	116
Configuring the Data Recorder.....	116
<b>5.6 Configuring Communication Protocols.....</b>	<b>119</b>
Configuring Modbus.....	119
Configuring DNP3.....	120

<b>Chapter 6 Device Control and Upgrading.....</b>	<b>123</b>
6.1 Resetting Accumulators, Maximum Values and Files.....	123
6.2 Updating the Meter Clock.....	125
6.3 Viewing and Clearing Device Diagnostics.....	126
6.4 Viewing Communication Status and Statistics.....	126
6.5 Remote Relay Control.....	127
6.6 Upgrading Device Firmware.....	128
<b>Chapter 7 Monitoring Meters .....</b>	<b>130</b>
7.1 Viewing Real-time Data.....	130
7.2 Viewing Real-time Min/Max Log .....	133
7.3 Viewing Real-time Waveforms .....	133
7.4 Viewing Real-time Harmonic Spectrum.....	135
<b>Chapter 8 Retrieving and Storing Files.....</b>	<b>139</b>
8.1 Uploading Files on Demand .....	139
8.2 Using the Upload Scheduler.....	140
8.3 Viewing Files On-line.....	142
8.4 Exporting Files.....	142
Exporting Files in COMTRADE and PQDIF Formats.....	142
Exporting Files in Excel Format .....	143
8.5 Archiving Files .....	144
<b>Chapter 9 Viewing Files .....</b>	<b>145</b>
9.1 Operations with Files .....	145
9.2 Viewing Options.....	145
Customizing Views .....	145
Working with Tables.....	146
Working with Graphic Windows.....	146
9.3 Viewing the Event Log .....	148
9.4 Viewing the Data Log.....	149
<b>Appendix A Technical Specifications .....</b>	<b>151</b>
<b>Appendix B Standards Compliance.....</b>	<b>157</b>
<b>Appendix C Analog Output Parameters .....</b>	<b>160</b>
<b>Appendix D Setpoint Triggers and Actions .....</b>	<b>162</b>
<b>Appendix E Parameters for Data Monitoring and Logging.....</b>	<b>165</b>
<b>Appendix F Billing/TOU Profile Log File .....</b>	<b>174</b>
<b>Appendix G Data Scales.....</b>	<b>176</b>
<b>Appendix H Device Diagnostic Codes .....</b>	<b>177</b>

# Chapter 1 General Information



The EM13X Series is a compact, multi-function, three-phase AC Powermeter specially designed to meet the requirements of users ranging from electrical panel builders to substation operators.

⇒	The EM13X Series measuring and power supply inputs comply with Measuring Category III
---	---

The EM13X Series offers standard voltage, current, power and frequency measurements, amp-demand, energy measurements and data logging, harmonic analysis and control capabilities.

The EM13X Series consists of three different models series:

- EM132/EM133 with AC/DC Auxiliary Power Supply (40-318V AC/DC)
  - EM132/EM133-5, internal CT, transformer operated configuration with current inputs:  $I_n = 5A$ ,  $I_{max} = 10A$
  - EM132/EM133-1, internal CT, transformer operated configuration with current inputs:  $I_n = 1A$ ,  $I_{max} = 2A$
  - EM132/EM133-RS5, external CT, transformer operated configuration with current inputs (secondary current):  $I_n = 2.mA$ ,  $I_{max} = 5mA$
  - EM132/EM133-50, internal CT, direct connection configuration with current inputs:  $I_n = 50A$ ,  $I_{max} = 63A^1$
  - EM132/EM133-HACS, external CT, direct connection configuration with current inputs (secondary current):  $I_n = 20mA$ ,  $I_{max} = 40mA$
- EM133-SE – self energized device with 3 Phase Power Supply, operating from any combination of the measured phases
  - EM133-SE-5, internal CT, transformer operated configuration with current inputs:  $I_n = 5A$ ,  $I_{max} = 10A$
  - EM133-SE-1, internal CT, transformer operated configuration with current inputs:  $I_n = 1A$ ,  $I_{max} = 2A$
  - EM133-SE-RS5, external CT, transformer operated configuration with current inputs (secondary current):  $I_n = 2.mA$ ,  $I_{max} = 5mA$

<sup>1</sup>  $I_{max} = 63A$  at 60°C max. amb. temperature,  $I_{max} = 100A$  at 55°C max. amb. temperature

- EM133-SE-50, internal CT, direct connection configuration with current inputs: In = 50A, I<sub>max</sub> = 63A<sup>1</sup>
- EM133-SE-HACS, external CT, direct connection configuration with current inputs (secondary current): In = 20mA, I<sub>max</sub> = 40mA
- EM132/EM133-21DC with DC Auxiliary Power Supply (9-36 VDC)
  - EM132/EM133-21DC-5, internal CT, transformer operated configuration with current inputs: In = 5A, I<sub>max</sub> = 10A
  - EM132/EM133-21DC-1, internal CT, transformer operated configuration with current inputs: In = 1A, I<sub>max</sub> = 2A
  - EM132/EM133-21DC-RS5, external CT, transformer operated configuration with current inputs (secondary current): In = 2.mA, I<sub>max</sub> = 5mA
  - EM132/EM133-21DC-50, internal CT, direct connection configuration with current inputs: In = 50A, I<sub>max</sub> = 63A<sup>1</sup>
  - EM132/EM133-21DC-HACS, external CT, direct connection configuration with current inputs (secondary current): In = 20mA, I<sub>max</sub> = 40mA

All models series include the following units:

- 2 lines of 16 characters LCD display.
- A standard RS-485 communication port, Infra-Red Communication port and an additional optional Ethernet, Profibus or RS-232/RS-422/RS-485 or RF Modem port. These ports allow local and remote automatic meter readings and setup through the supplemental communication or user data acquisition software
- Different communication options for remote communications with the meter. These options enable LAN and Internet communication with the unit.
- Two digital inputs with 10-ms scan time and one relay output with 1-cycle update time

The EM13X Series is suitable for mounting on both standard DIN-Rail and wall-mount.

The EM13X firmware Series consists of various firmware implementations and resources as described in following table:

Versions	Communication protocols								App.	Storage memory	CPU memory
	MODBUS/RTU	ASCII	SATEC	DNP	Profibus	CAN	WiFi	60870	AR	8 MB	512 kB
V12.02.xx	V	–	–	V	V	V	V	–	–	–	–
V12.05.xx	V	–	–	–	V	V	V	–	V	–	–
V12.06.xx	V	–	V	–	V	–	–	–	–	–	–
V12.07.xx	V	–	–	–	V	V	V	–	V	V	–
V12.08.xx	V	–	–	V	V	V	V	–	–	–	V
V12.22.xx	V	–	–	–	V	–	V	V	–	–	–
V12.28.xx	V	–	–	–	V	–	V	V	–	–	V

<sup>1</sup> I<sub>max</sub>= 63A at 60°C max. amb. temperature, I<sub>max</sub>=100A at 55°C max. amb. temperature

## 1.1 Features

### Multifunctional 3-phase Power Meter

- 3 voltage inputs and 3 current transformer-isolated AC inputs for direct connection to power line or via potential and current transformers
- True RMS, volts, amps, power, power factor, neutral current, voltage and current unbalance, frequency
- Ampere/Volt demand meter
- 25/50/60/400<sup>1</sup> Hz measurement capabilities

### Billing/TOU Energy Meter

- IEC 62053-22 Class 0.5S /ANSI C12.20 Acc. Class 0.5, four-quadrant active and reactive energy polyphase static meter
- Three-phase total and per phase energy measurements; active, reactive and apparent energy counters
- Time-of-Use, 4 totalization and tariff energy/demand registers x 8 tariffs, 4 seasons x 4 types of days, 8 tariff changes per day,
- One-time easy programmable tariff calendar schedule
- Automatic daily energy and maximum demand profile log for total and tariff registers
- Voltage and current THD, current TDD and K-Factor, up to 40th order harmonic
- Voltage and current harmonic spectrum and angles

### Real-time Waveform Capture

- Real-time "scope mode" waveform monitoring capability
- Simultaneous 6-channel one-cycle waveform capture at a rate of 64 samples per cycle

### Programmable Logical Controller

- Embedded programmable controller
- 16 control setpoints; programmable thresholds and delays
- Relay output control
- 1-cycle response time
- Non-volatile memory for long-term event and data recording
- Event recorder for logging internal diagnostic events and setup changes
- Two data recorders; programmable data logs on a periodic basis; automatic daily energy and maximum demand profile log

### Digital I/O

- 2 digital inputs (standard) and four to twelve digital inputs (optional) with 1/2 cycle scan time; automatic recording of last five digital input

---

<sup>1</sup> 25Hz and 400Hz options are available only with internal CT.

change events with timestamps (see the EM13X Series MODBUS Reference Guide)

- 1 relay output (standard) and two to four relay outputs (optional) with 1-cycle update time; unlatched, latched, pulse and KYZ operation; energy pulses

#### Display

- Easy to read 2x16 characters LCD display, adjustable update time
- Auto-scroll option with adjustable page exposition time; auto-return to a default page
- Programmable display auto-scroll sequence

#### Communications

- Standard 2-wire RS-485 communication port; MODBUS RTU, DNP3, SATEC ASCII and IEC 60870-5-101 communication protocols
- Optional second communication port; MODBUS RTU, MODBUS/TCP, DNP3, DNP3/TCP, SATEC ASCII, PROFIBUS DP, CANopen and IEC 60870-5-104 (over TCP) communication protocols
- eXpertPower™ client for communicating with the SATEC proprietary eXpertPower™ Internet services (with the Ethernet/GPRS module)
- TCP notification client for communicating with a remote MODBUS/TCP server on events or periodically on a time basis (with the Ethernet/GPRS module)

#### Meter Security

- Password security for protecting meter setups and accumulated data from unauthorized changes

#### Upgradeable Firmware

- Easy upgrading device firmware through a serial or Ethernet port.

#### Software Support

- PAS™ – meter configuration and data acquisition SATEC Software tool
- eXpertPower™ – SATEC proprietary Internet services

## 1.2 Available Options

The EM13X Series can be provided with an optional expansion module from the following list:

- Digital I/O
- Analog outputs
- Ethernet communication port
- PROFIBUS DP communication port
- CANopen communication port
- RS-232/RS-422/RS-485 communication port
- Cellular communication port based on ENFORA GPRS or TELIT 3G or 4G engine
- RF communication port

- WiFi module, wireless Ethernet communication port

## **Digital I/O**

The EM13X Series digital I/O expansion module provides:

### **4DI/2RO Module**

- 4 dry contact digital inputs (DI) for monitoring external contacts and receiving pulses from energy, water, and gas meters; Programmable de-bounce time; 1-ms scan time.
- 2 electro-mechanical or solid-state relay outputs (RO) for alarms and controls, and for output energy pulses; unlatched, latched and pulse operations, failsafe operation for alarm notifications; programmable pulse width; direct remote relay control through communications; 1-cycle update time.

### **8DI module**

- 8 dry contact digital inputs (DI) for monitoring external contacts and receiving pulses from energy, water, and gas meters
- Programmable de-bounce time; 1-ms scan time.

### **12DI/4RO Module**

- 12 dry contact digital inputs (DI) for monitoring external contacts and receiving pulses from energy, water, and gas meters; Programmable de-bounce time; 1-ms scan time.
- 4 electro-mechanical relay outputs (RO) for alarms and controls, and for output energy pulses; unlatched, latched and pulse operations, failsafe operation for alarm notifications; programmable pulse width; direct remote relay control through communications; 1-cycle update time.

## **Analog Output**

The EM13X Series analog output (AO) expansion module provides:

- 4 optically isolated analog outputs with an internal power supply;
- Options for 0-20mA, 4-20mA, 0-1mA, and  $\pm$  1mA output; 1-cycle update time.

## **Additional Communication Port– COM2**

A second COM2 communication port can be ordered as an expansion module. COM2 options available:

- Ethernet 10/100BaseT port; MODBUS/TCP, DNP3/TCP or IEC 60870-5-104 communications protocols
- WiFi module, wireless Ethernet communication port
- PROFIBUS DP port
- CANopen port
- RS-232/RS-422/RS-485 port; MODBUS RTU, DNP3 or IEC 60870-5-101, and SATEC ASCII communication protocols;
- GPRS or 3G/4G cellular communications port; MODBUS/TCP protocol
- RF communication; MODBUS RTU protocol

## 1.3 Customized Options

Presentation of data on the front display and via communications can be customized to best suit the user application.

### Device Resolution

A low or high-resolution option can be selected for the presentation of voltage, current, and power for use in high and low power applications.

### Display Options

Different display options are available for customization to be used in dark or non-safe locations, or in places that are hardly accessible for observation.

## 1.4 Measured Parameters

**Table 1: Measured and Displayed Parameters**

Parameter	Display	Comm.	Analog	Pulse	Alarm
<b>1-cycle Real-time Measurements</b>					
RMS Voltage per phase		✓	✓		✓
RMS Current per phase		✓	✓		✓
kW per phase		✓			✓
kvar per phase		✓			✓
kVA per phase		✓			✓
Power Factor per phase		✓			✓
Total kW		✓	✓		✓
Total kvar		✓	✓		✓
Total kVA		✓	✓		✓
Frequency		✓	✓		✓
Neutral Current		✓	✓		✓
Total Power Factor		✓	✓		✓
Voltage & Current unbalance		✓			✓
<b>1-sec Average Measurements</b>					
RMS Voltage per phase	✓	✓	✓		✓
RMS Current per phase	✓	✓	✓		✓
kW per phase	✓	✓			✓
kvar per phase	✓	✓			✓
kVA per phase	✓	✓			✓
Power Factor per phase	✓	✓			✓
Total kW	✓	✓	✓		✓
Total kvar	✓	✓	✓		✓
Total kVA	✓	✓	✓		✓
Total Power Factor	✓	✓	✓		✓
Frequency	✓	✓	✓		✓
Neutral Current	✓	✓	✓		✓
Voltage & Current unbalance	✓	✓			✓
<b>Amps &amp; Volt Demands</b>					
Ampere & Volt Demand per phase		✓			✓
Ampere Maximum Demand per phase	✓	✓			✓
Voltage Maximum Demand per phase	✓	✓			✓
<b>Power Demands</b>					
kW Accumulated Demand Import & Export		✓	✓		✓



<b>Parameter</b>	<b>Display</b>	<b>Comm.</b>	<b>Analog</b>	<b>Pulse</b>	<b>Alarm</b>
kvar Accumulated Demand Import & Export		✓	✓		✓
kVA Accumulated Demand		✓	✓		✓
kW Demand Import & Export		✓			✓
kvar Demand Import & Export		✓			✓
kVA Demand		✓			✓
kW Sliding Demand Import & Export		✓			✓
kvar Sliding Demand Import & Export		✓			✓
kVA Sliding Demand		✓			✓
kW Predicted Demand Import & Export		✓			✓
kvar Predicted Demand Import & Export		✓			✓
kVA Predicted Demand		✓			✓
kW Maximum Demand Import	✓	✓			
kW Maximum Demand Export	✓	✓			
kvar Maximum Demand Import	✓	✓			
kvar Maximum Demand Export		✓			
kVA Maximum Demand	✓	✓			
<b>Total Energy</b>					
Total kWh Import & Export	✓	✓		✓	
Total kvarh Import & Export	✓	✓		✓	
Total kvarh Net		✓			
Total kVAh	✓	✓		✓	
<b>Energy per Phase</b>					
kWh Import per phase	✓	✓			
kvarh Import per phase		✓			
kVAh per phase	✓	✓			
<b>TOU Registers</b>					
4 TOU energy registers (kWh and kvarh import & export, kVAh, 4 pulse sources)	✓	✓			
4 TOU maximum demand registers		✓			
8 tariffs, 4 seasons x 4 types of day	✓	✓			✓
<b>Harmonic Measurements<sup>EH</sup></b>					
Voltage THD per phase	✓	✓	✓		✓
Current THD per phase	✓	✓	✓		✓
Current TDD per phase	✓	✓	✓		✓
K-factor per phase	✓	✓	✓		✓
Voltage harmonics per phase up to order 40		✓			
Current harmonics per phase up to order 40		✓			
Voltage harmonic angles up to order 40		✓			
Current harmonic angles up to order 40		✓			
<b>Fundamental Component</b>					
Voltage and Current per phase	✓	✓			
kW, PF per phase	✓	✓			
kvar, KVA per phase	✓	✓			
Total kW, PF	✓	✓			
Total kvar, KVA	✓	✓			
<b>Min/Max Logging</b>					
Min/Max A, V, total kW, kvar, kVA, PF	✓	✓			
Min/Max Frequency, Neutral current	✓	✓			
<b>Phase Rotation</b>	✓	✓			✓
<b>Voltage and Current Phase Angles</b>	✓	✓			
<b>Day and Time</b>	✓	✓			

Parameter	Display	Comm.	Analog	Pulse	Alarm
<b>Pulse Counters</b>	✓	✓			✓
<b>Digital Inputs (optional)</b>	✓	✓			✓
<b>Relay Outputs (optional)</b>	✓	✓			✓
<b>Remote Relay Control (optional)</b>		✓			
<b>Alarm Triggers/Setpoints</b>		✓			✓
<b>Self-diagnostics</b>	✓	✓			

## 1.5 Labelling

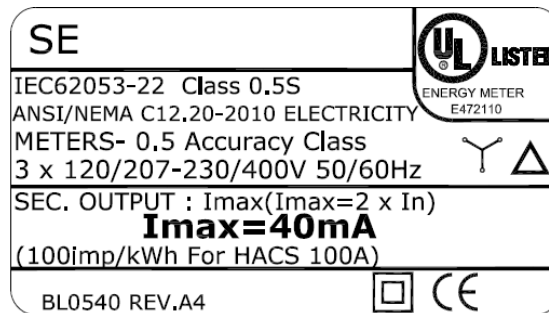


Figure 1-1 EM133 label – UL marking

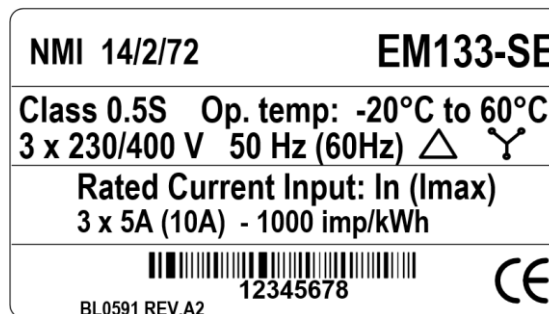


Figure 1-2 EM133 label – NMI marking

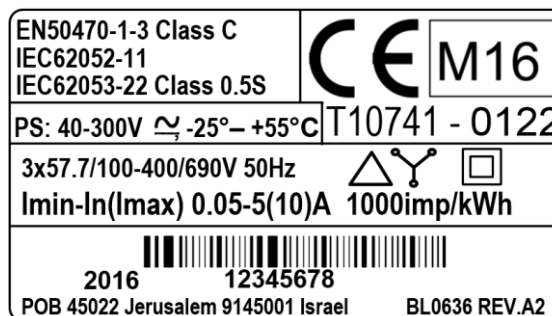


Figure 1-3 EM133 label – CE MID marking

# Chapter 2 Installation

This chapter discusses the following types of physical installations for the EM13X Series SMART MULTIFUNCTION METER:

- Mechanical Installation
- Electrical Installation
- I/O Connections
- COM Port Connections.

## 2.1 Site Requirements

- Environmental conditions: as specified in Technical Specifications in Appendix A
- Electrical requirements: as specified in Technical Specifications in Appendix A

See [Technical Specifications](#) in Appendix A for more details

## 2.2 Package Contents

The EM13X Series SMART MULTIFUNCTION METER package contains the following items:

- EM13X Series SMART MULTIFUNCTION METER unit
- Technical Documentation CD
- EM13X Series Quick Start guide

## 2.3 Mechanical Installation

Refer to the figures provided in this section to properly perform the mechanical installation.

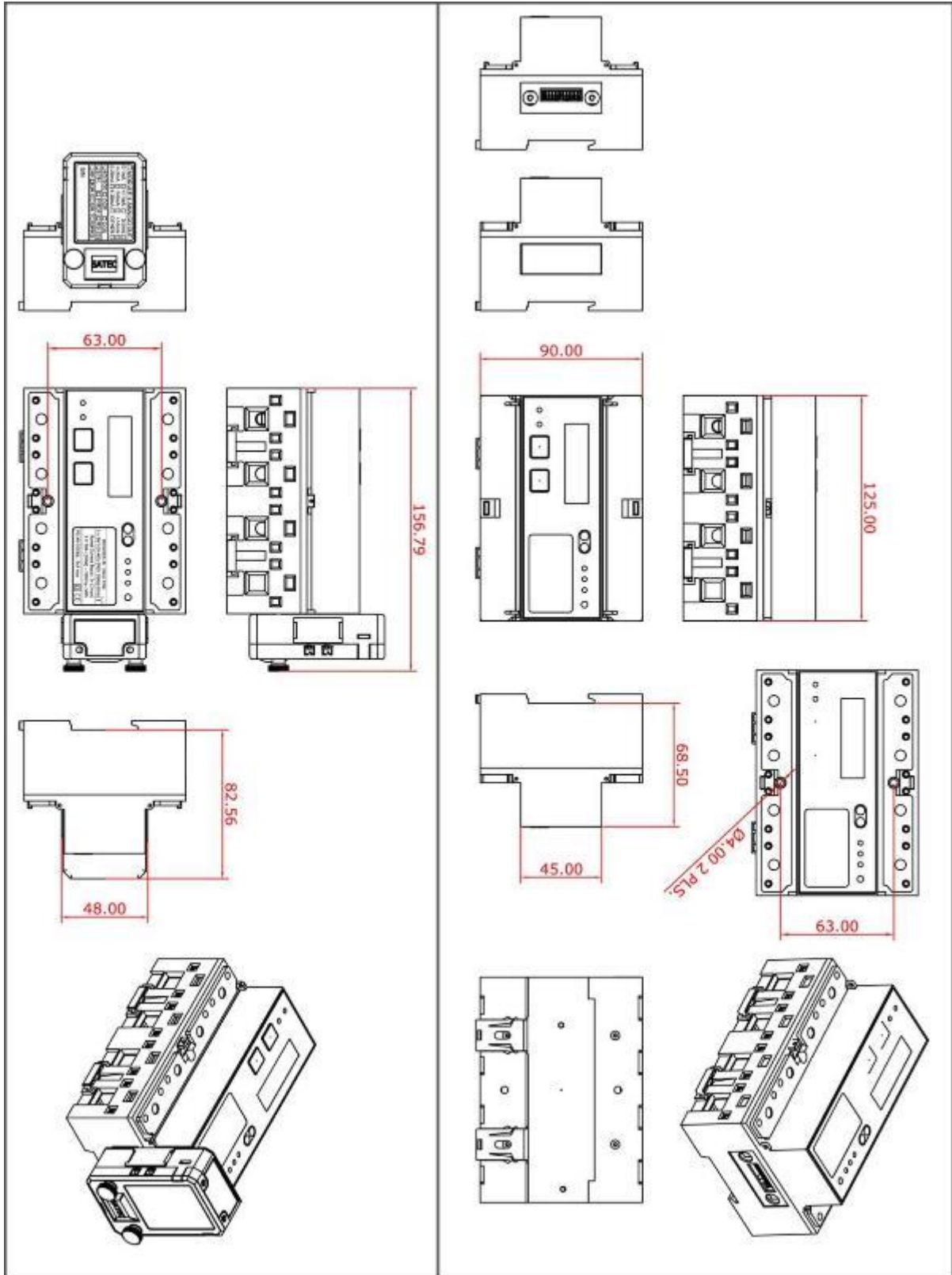


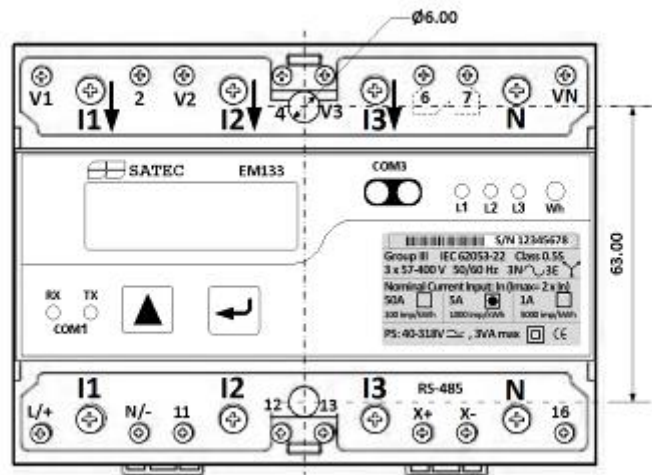
Figure 2-1 Dimensions

## Wall Mounting

### To mount the meter on the wall:

Position the meter on the wall according to hole locations as shown in figure 2-2

Affix the meter using washers and nuts.



**Figure 2-2. Surface Mounting**

## DIN Rail Mounting

The EM13X Series can be mounted on a standard 35-mm DIN rail as shown in figure 2-3

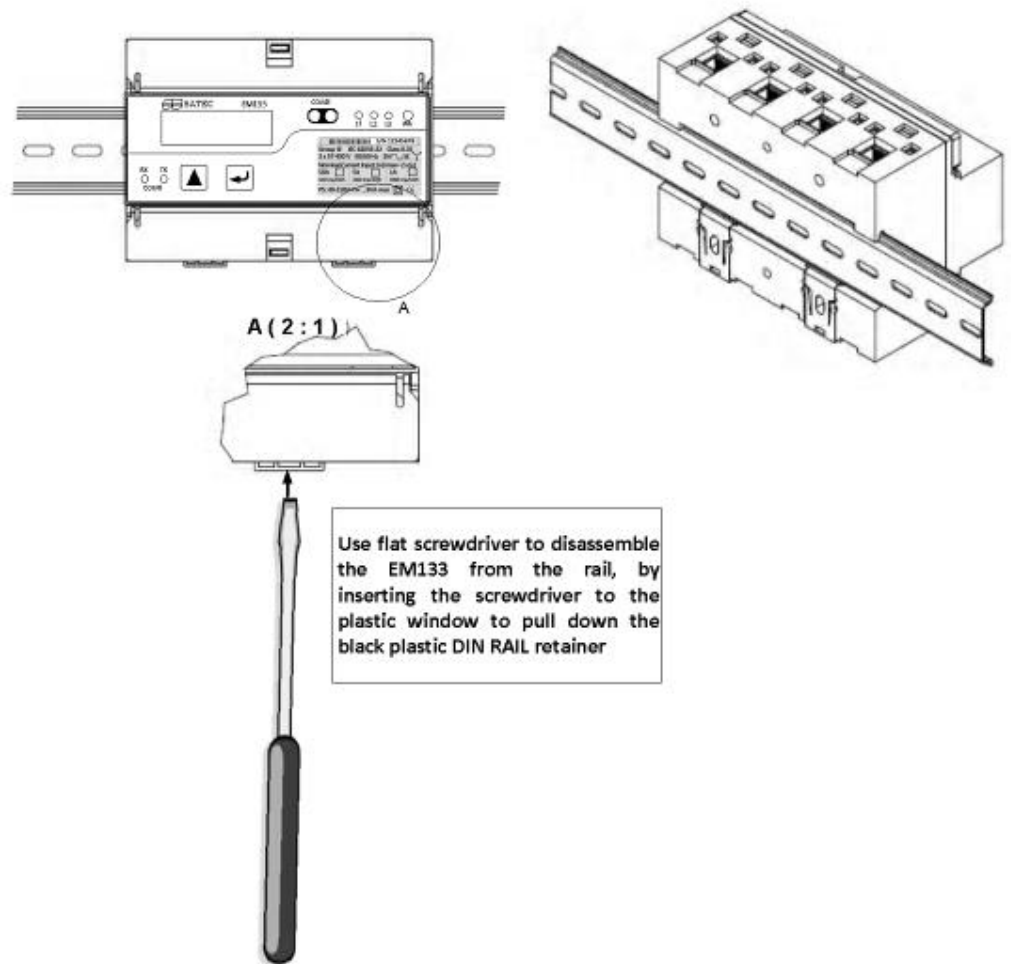


Figure 2-3. EM13X Series DIN Rail Mounting

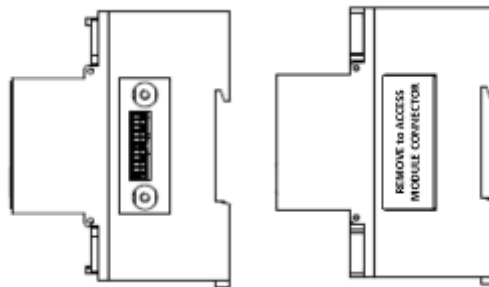
## Add-On Module Mounting



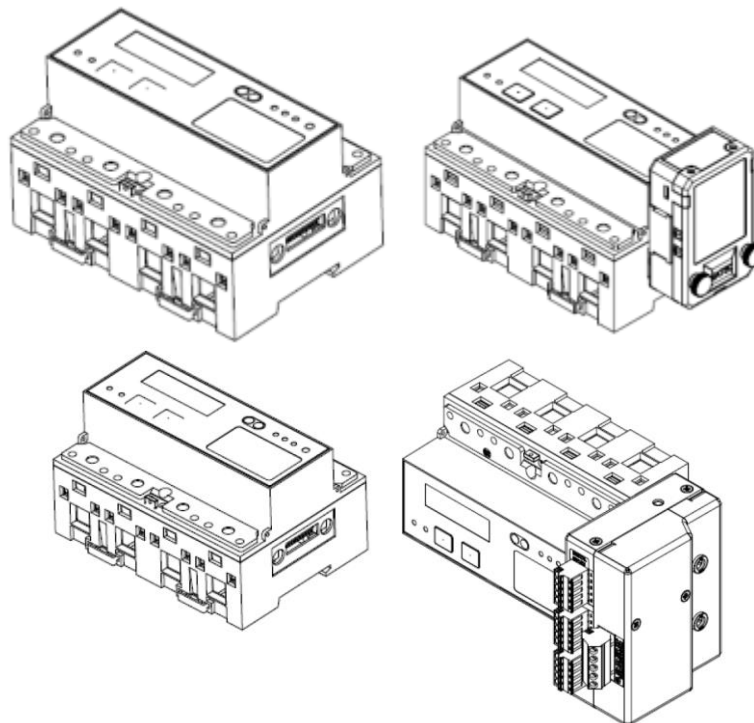
Before Add-On Module installation ensure that all incoming power sources are shut OFF. Failure to observe this practice can result in serious or even fatal injury and damage to equipment.

Turn off the EM13X Series auxiliary power supply or voltage supply inputs (SE model).

Remove the module connector cover from the EM13X Series to access the module connector as shown in figure 2-4below



**Figure 2-4. EM13X Series module connector location**



**Figure 2-5. EM13X Series module assembly**

## 2.4 Electrical Installation



The equipment installation shall conform to the following instructions:

- a switch or circuit-breaker shall be included in the building installation as close as possible to the equipment supply voltage;
- It shall be in close proximity to the equipment and within easy reach of the OPERATOR;
- It shall be marked as the disconnecting device for the equipment.
- Before installing, ensure that all incoming power sources are shut OFF. Failure to observe this practice can result in serious or even fatal injury and damage to equipment.
- The current sensors may not be installed in a panel where they exceed 75% of the wiring space of any cross-sectional area within the panel.

## Connecting the wires

All conductors must be stranded copper. All conductors and insulation systems and crimped devices must be appropriate for the application. SATEC requires using crimped ferrules on stranded wire.

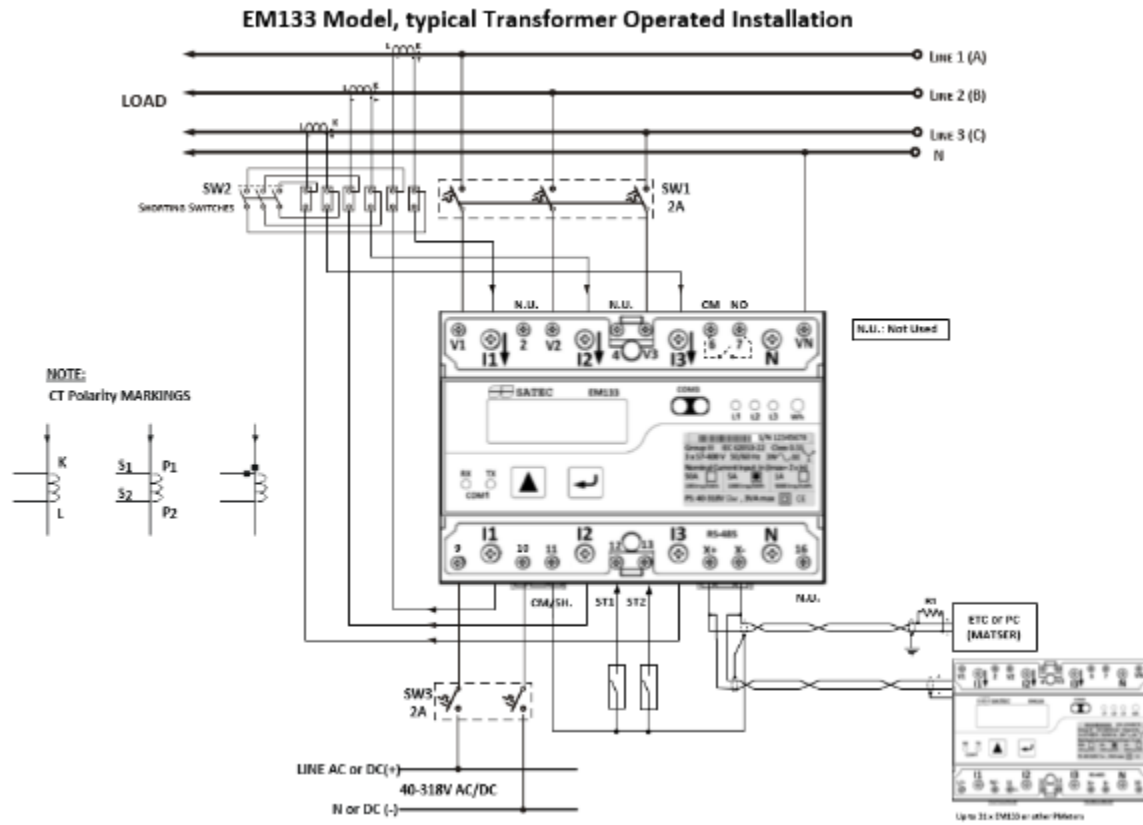
Table 3 below summarizes the different conductors' sizes to be used in the EM133 external connections.

**Table 2: Wiring Characteristics**

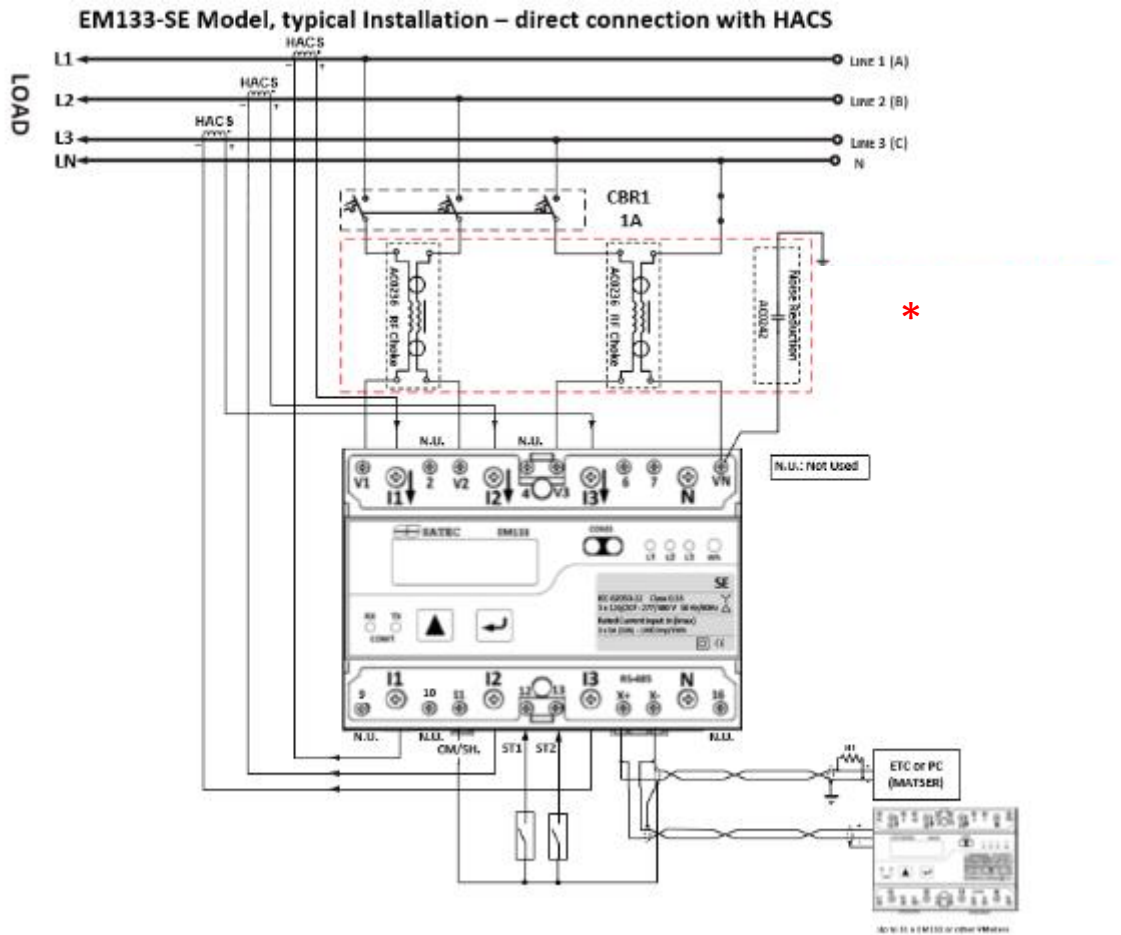
Terminals	Conductor size			Torque [Nm]	Notes
	EM133 model	Minimum AWG (mm <sup>2</sup> )	Maximum AWG (mm <sup>2</sup> )		
Aux. Power Supply Inputs L/+, N/-	N/A in EM133-SE models	22 (0.5)	12 (4.0)	0.5-0.7	Use 600V insulated conductors Required crimped ferrule: Panduit (22AWG) F75-10-M Panduit (12AWG) F81-15-M
Voltages Inputs V1, V2, V3, Vn	N/A in EM133-SE-100A	22 (0.5)	12 (4.0)	0.5-0.7	Use 600V insulated conductors Required crimped ferrule: Panduit (22AWG) F75-10-M Panduit (12AWG) F81-15-M
Current Inputs I1, I2, I3, N	EM133/SE-1A, 5A, HACS	22 (0.5)	10 (6.0)	1.8-2	Use 600V insulated conductors Required crimped ferrule: Panduit (22AWG) F75-10-M Panduit (10AWG) F82-15-M
Current Inputs I1, I2, I3, N	EM133/SE-63A or 100A	6 (16)	4 (25)	2-2.7	Use 600V insulated conductors Required crimped ferrule: Panduit (6AWG) F84-15-M Panduit (4AWG) F85-15-M
COM1, I/O connections	All Models	22 (0.5)	12 (4.0)	0.5-0.7	Use 600V insulated conductors Required crimped ferrule: Panduit (22AWG) F75-10-M Panduit (12AWG) F81-15-M



## Typical Installation

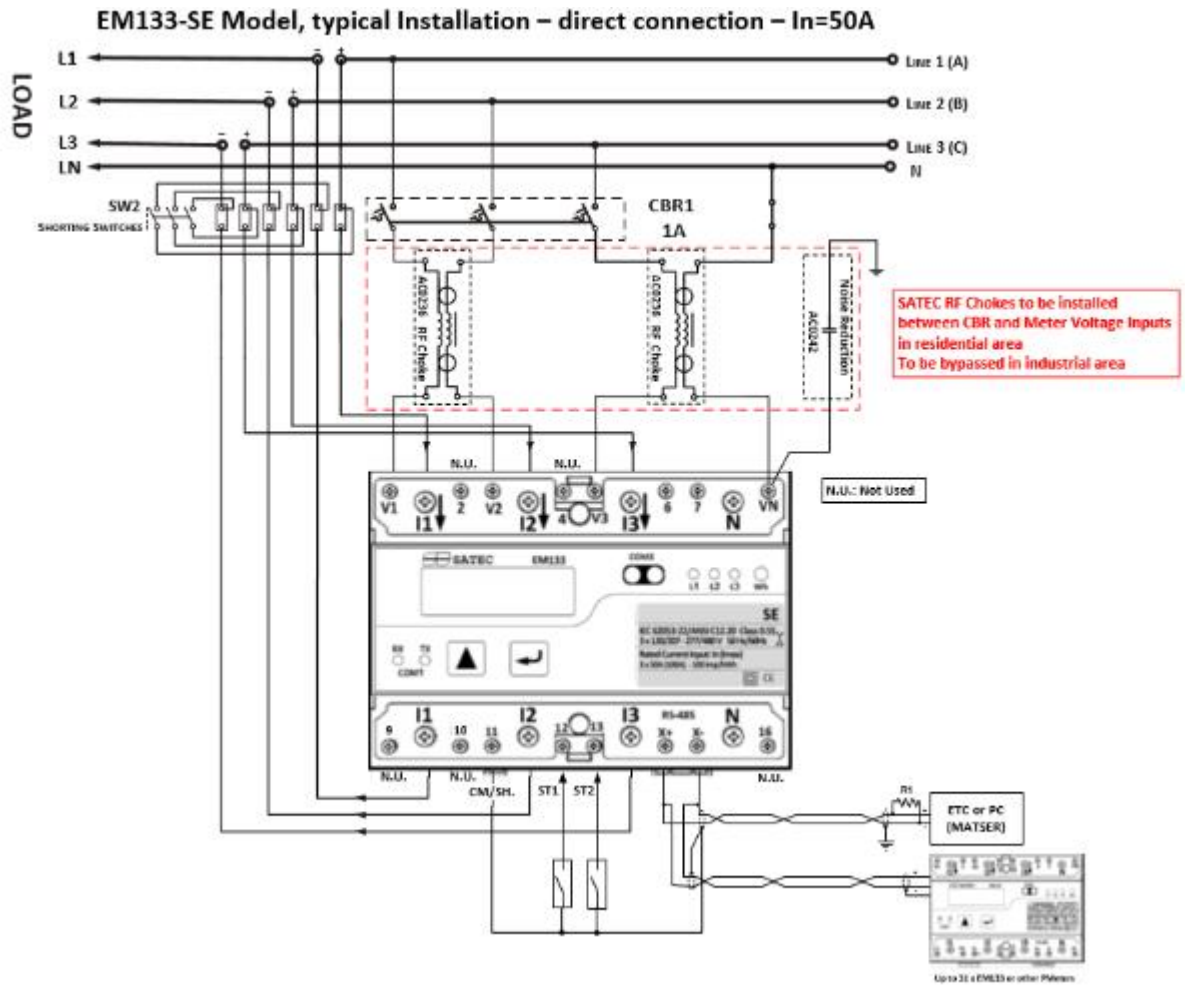


**Figure 2-6a Typical Installation Diagram with Auxiliary Power Supply**

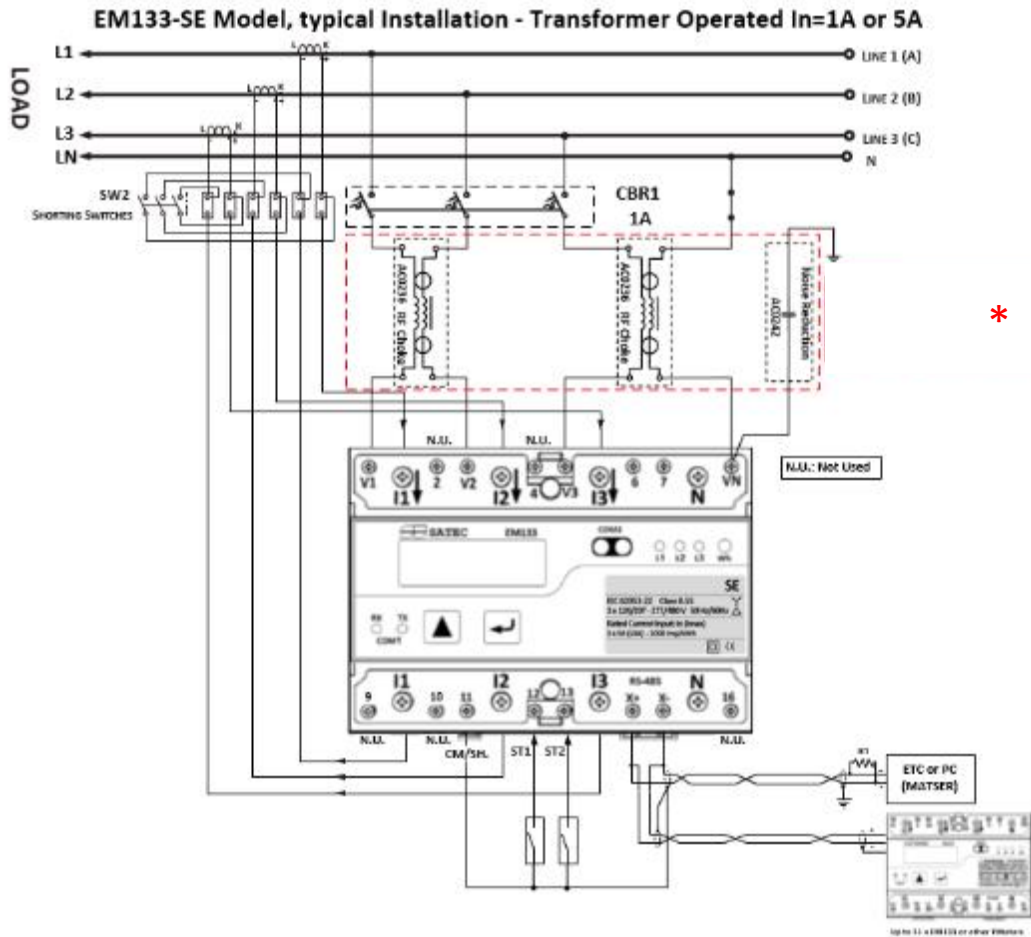


- \* 1. SATEC RF chokes to be installed between CBR and Meter Voltage Inputs in residential area or other places require ANCI C12.20 compliance. Otherwise it may be bypassed.
- 2. AC0242 shall be routed with the voltage lines (bundled), separately from communication & I/O lines

Figure 2-6b Typical Installation Diagram with Self Energized Power Supply – direct connection with HACS

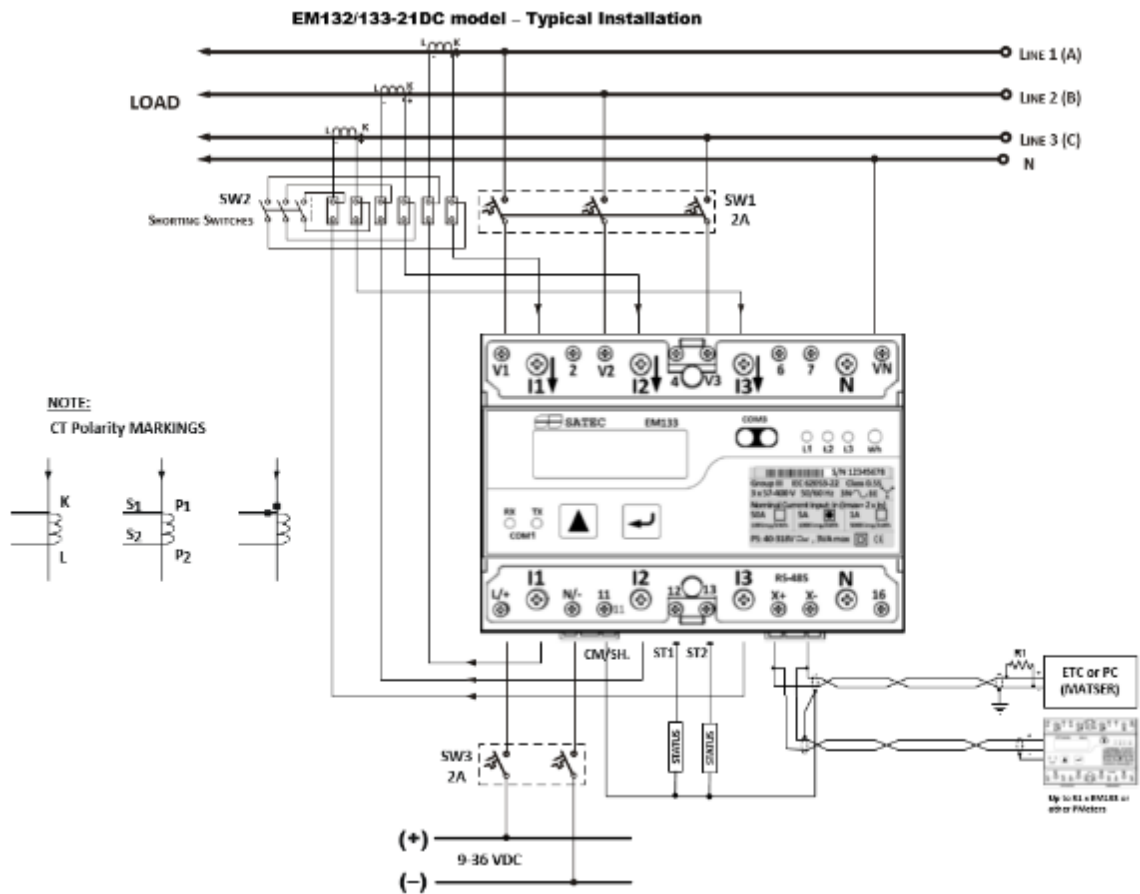


**Figure 2-6c Typical Installation Diagram with Self Energized Power Supply – direct connection**



- \*
  1. SATEC RF chokes to be installed between CBR and Meter Voltage Inputs in residential area or other places require ANCI C12.20 compliance. Otherwise it may be bypassed.
  2. AC0242 shall be routed with the voltage lines (bundled), separately from communication & I/O lines

**Figure 2-6d Typical Installation Diagram with Self Energized Power Supply – Transformer Operated (indirect connection)**

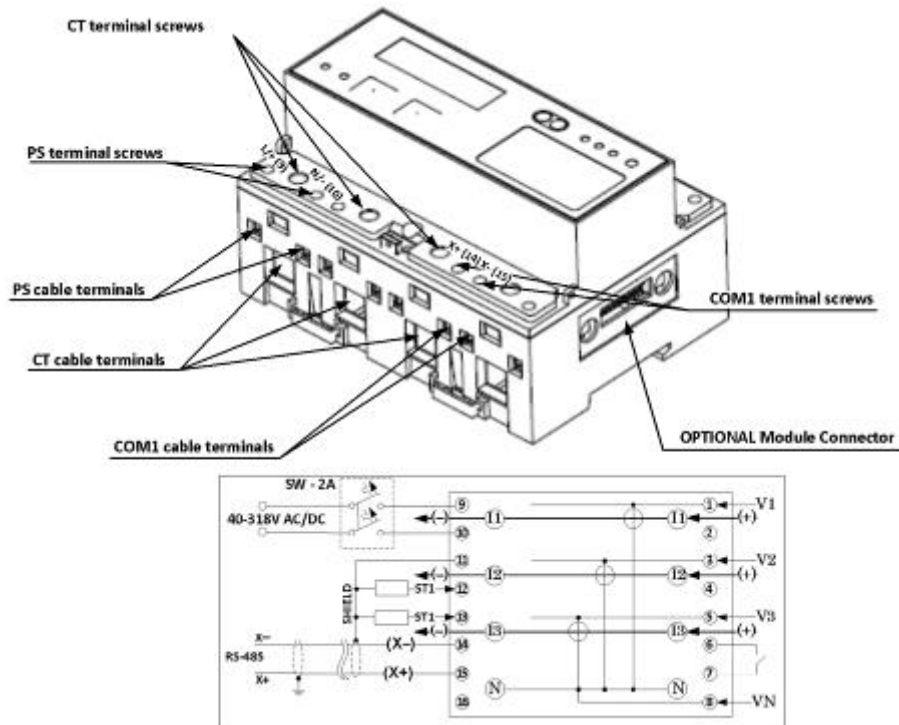


**Figure 2-6e Typical Installation Diagram with 12/24 VDC Auxiliary Power Supply**

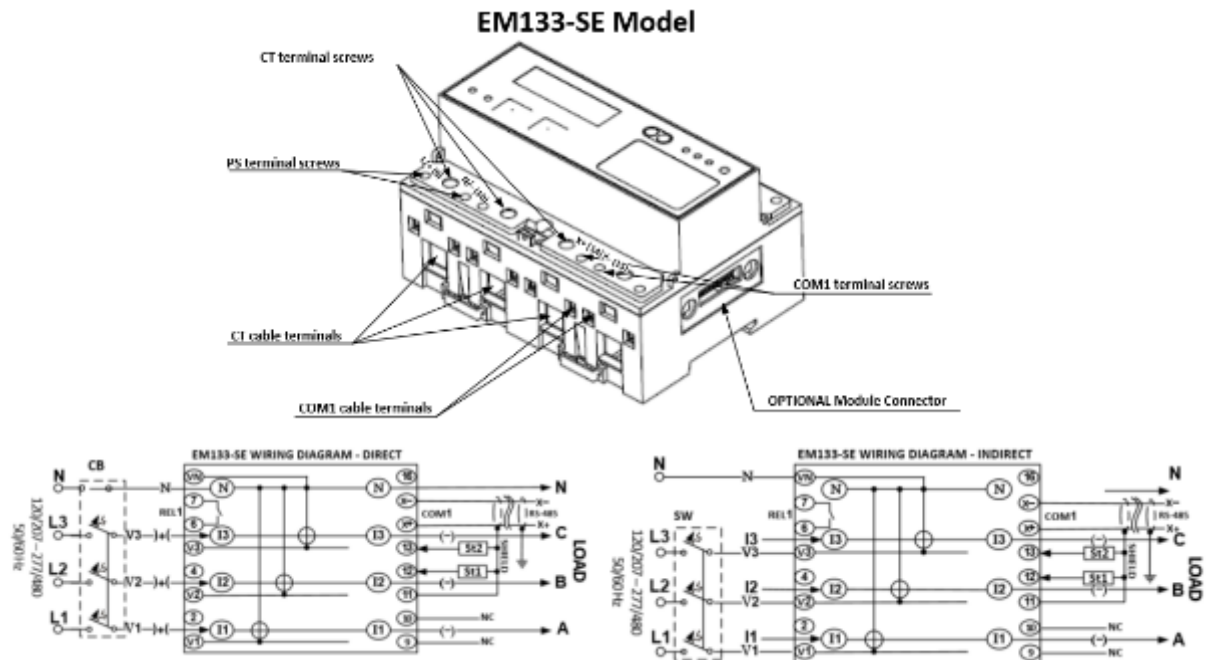
## Terminals

The EM132/133/133-SE terminals are constructed as a built-in part of the meter equipment. The terminals are divided in two different terminal categories:

- 1) High power terminal, dedicated to current terminals only, with a torque rating of 2.0-2.3Nm
- 2) Low power terminal, dedicated to voltage, Digital Inputs, COM1 and Relay output terminals only with a torque rating of 0.5-0.7Nm



**Figure 2-7a Terminals View EM133 Model**



**Figure 2-7b Terminals View EM133-SE Model**

## Power Source Connection



The equipment installation shall conform to the following instructions:

- a) a switch or circuit-breaker shall be included in the building installation as close as possible to the equipment supply voltage;
- b) It shall be in close proximity to the equipment and within easy reach of the OPERATOR;
- c) It shall be marked as the disconnecting device for the equipment.
- d) Before installing, ensure that all incoming power sources are shut OFF. Failure to observe this practice can result in serious or even fatal injury and damage to equipment.
- e) The current sensors may not be installed in a panel where they exceed 75% of the wiring space of any cross-sectional area within the panel.

The power source can be a dedicated fuse or a monitored voltage if it is within the instrument power supply range.

### **To connect an AC Auxiliary Power Supply (EM133 model only):**

Connect the Line wire to terminal (L/+ or 9).  
Connect the Neutral wire to terminal (N/- or 10)

### **To connect to a DC Auxiliary Power Supply (EM133 and EM133-21DC models only):**

Connect the positive wire to terminal (L/+ or 9)  
Connect the negative wire to terminal (N/- or 10)

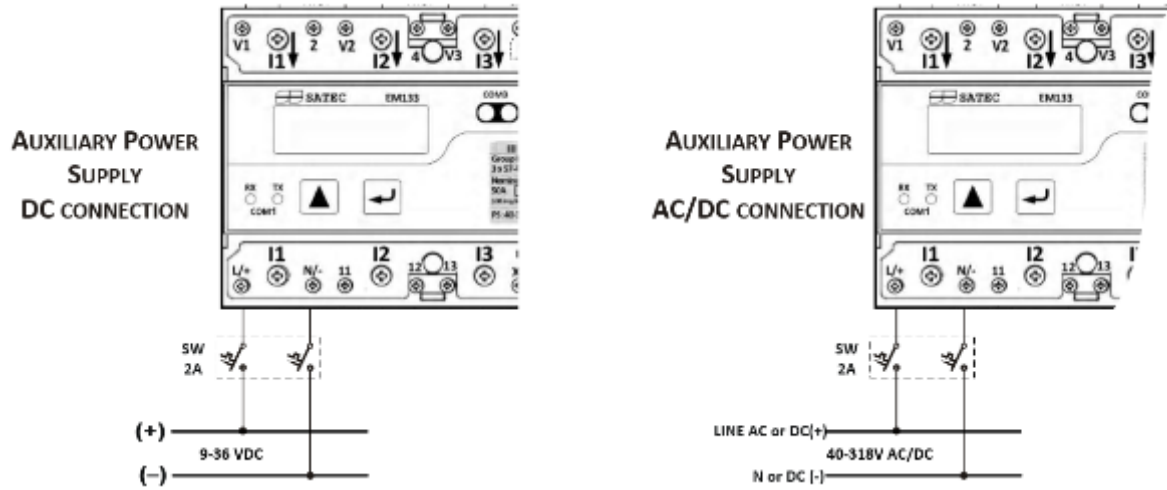



Figure 2-8 EM13X Series Auxiliary Power Supply connection



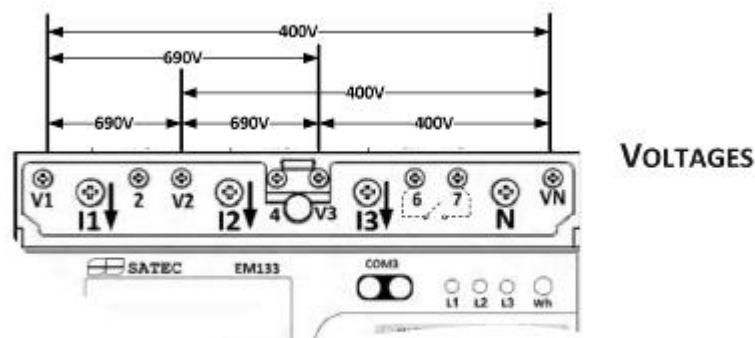
## Voltage Input connection



The equipment installation shall conform to the following instructions:

- a) a switch or circuit-breaker shall be included in the building installation as close as possible to the equipment supply voltage;
- b) It shall be in close proximity to the equipment and within easy reach of the OPERATOR;
- c) It shall be marked as the disconnecting device for the equipment.
- d) Before installing, ensure that all incoming power sources are shut OFF. Failure to observe this practice can result in serious or even fatal injury and damage to equipment.
- e) The current sensors may not be installed in a panel where they exceed 75% of the wiring space of any cross-sectional area within the panel.

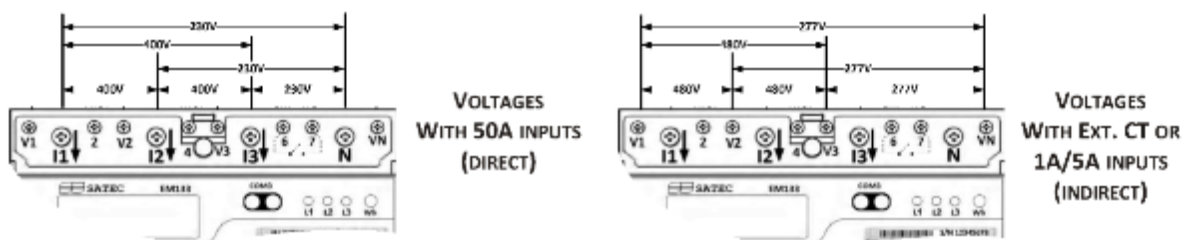
### EM13x Series (with Aux. Power Supply) 690V Inputs (Standard)



**Figure 2-9EM13X Series (with Aux. Power Supply) measured Voltage connections**

690V inputs are usually used with direct connection. Use any of the seven wiring configurations shown in Figures 2-8 through 2-15.

### EM13X-SE model Voltage connections



**Figure 2-10 EM13X-SE model measured Voltage connections**

EM133-SE model with measuring nominal current 1A or 5A or 2.5mA (using RS5), indirect connection – nominal voltage input is 120(207) to 277 (480) VAC.

EM133-SE model with measuring nominal current 50A or 20mA (using HACS), direct connection – nominal voltage input is up to 230(400) VAC.

## Current Input Connection

The EM13X Series consists of five different models according to the current inputs measurement:

1A nominal current (2A maximum) using internal CT – transformer operated Connection

5A nominal current (10A maximum) using internal CT – transformer operated Connection

50A<sup>1</sup> nominal current (63A/100A maximum) using internal CT – Direct Connection, in EM133-SE model Current Inputs and Voltage Inputs are internally connected together

20mA nominal current (40mA maximum) using HACS (external CT provided by SATEC) – Transformer Connection

2.5mA nominal current (5mA maximum) using RS5 (external CT provided by SATEC) – Transformer Connection

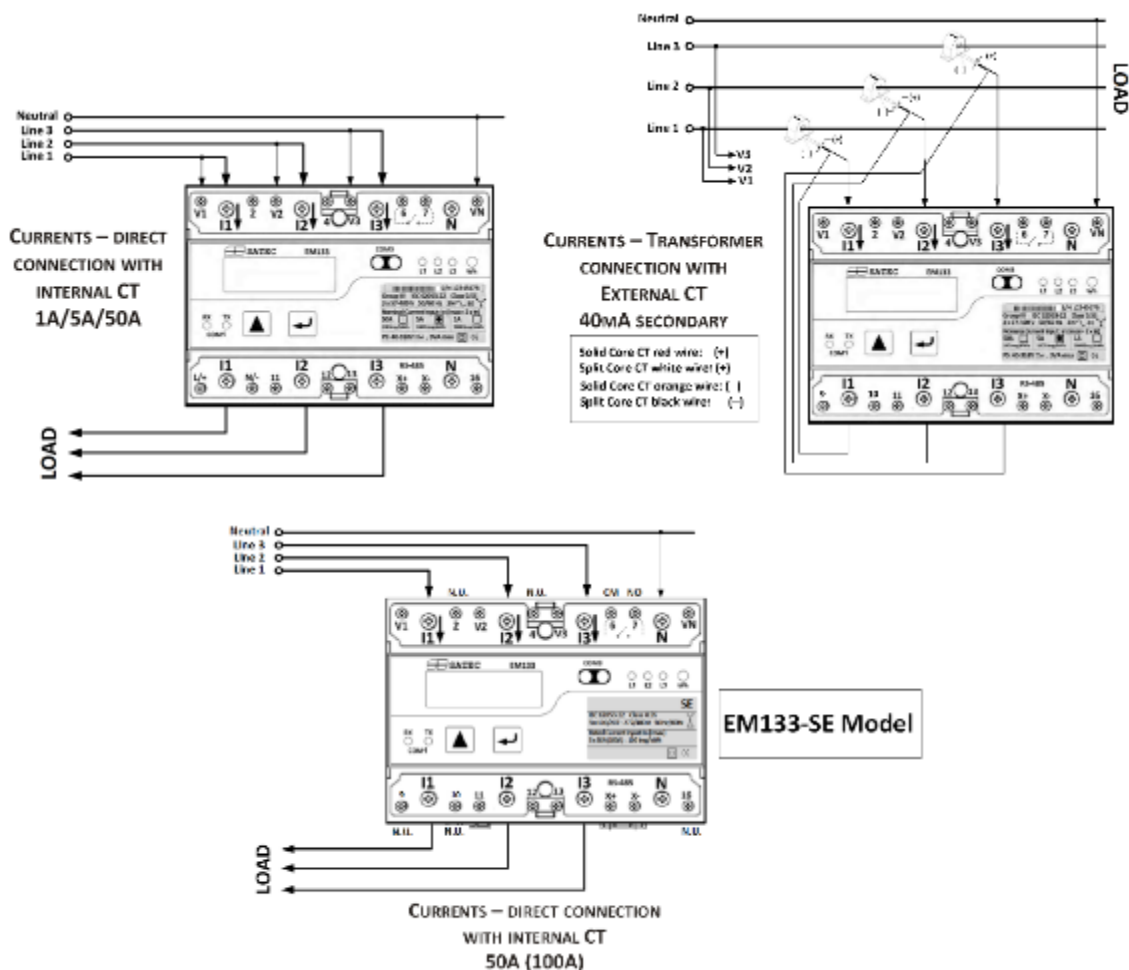


Figure 2-11 EM13X Series measured Current connections

<sup>1</sup> I<sub>max</sub>= 63A at 60°C max. amb. temperature, I<sub>max</sub>=100A at 55°C max. amb. temperature

## Wiring Diagrams

For AC input ratings, see [Technical Specifications](#) in Appendix A for more details.

Table 3 presents the available wiring configurations in the meter.

**Table 3: Wiring Configurations**

Wiring Configuration	Setup Code	Figure
3-wire 2-element Delta direct connection using 2 CTs	3dir2	2-12
4-wire 3-element Wye direct connection using 3 CTs	4Ln3 or 4LL3	2-13
4-wire 3-element Wye connection using 3 PTs, 3 CTs	4Ln3 or 4LL3	2-14
3-wire 2-element Open Delta connection using 2 PTs, 2 CTs	3OP2	2-15
4-wire 2½-element Wye connection using 2 PTs, 3 CTs	3Ln3 or 3LL3	2-16
3-wire 2½-element Open Delta connection using 2 PTs, 3 CTs	3OP3	2-17
4-wire 3-element Delta direct connection using 3 CTs	4Ln3 or 4LL3	2-18
3-wire 2½-element Broken Delta connection using 2 PTs, 3 CTs	3bLn3 or 3bLL3	2-19

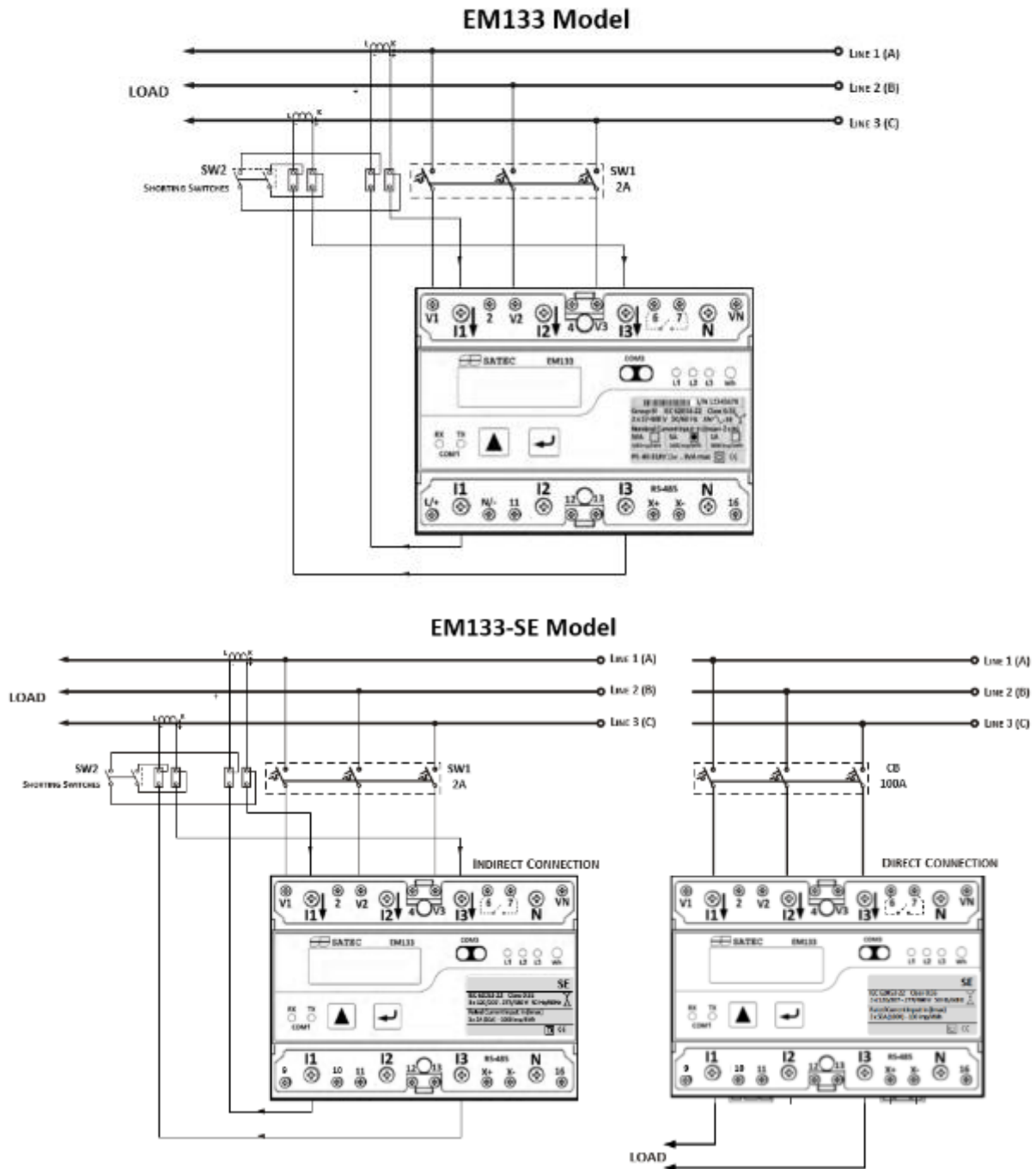
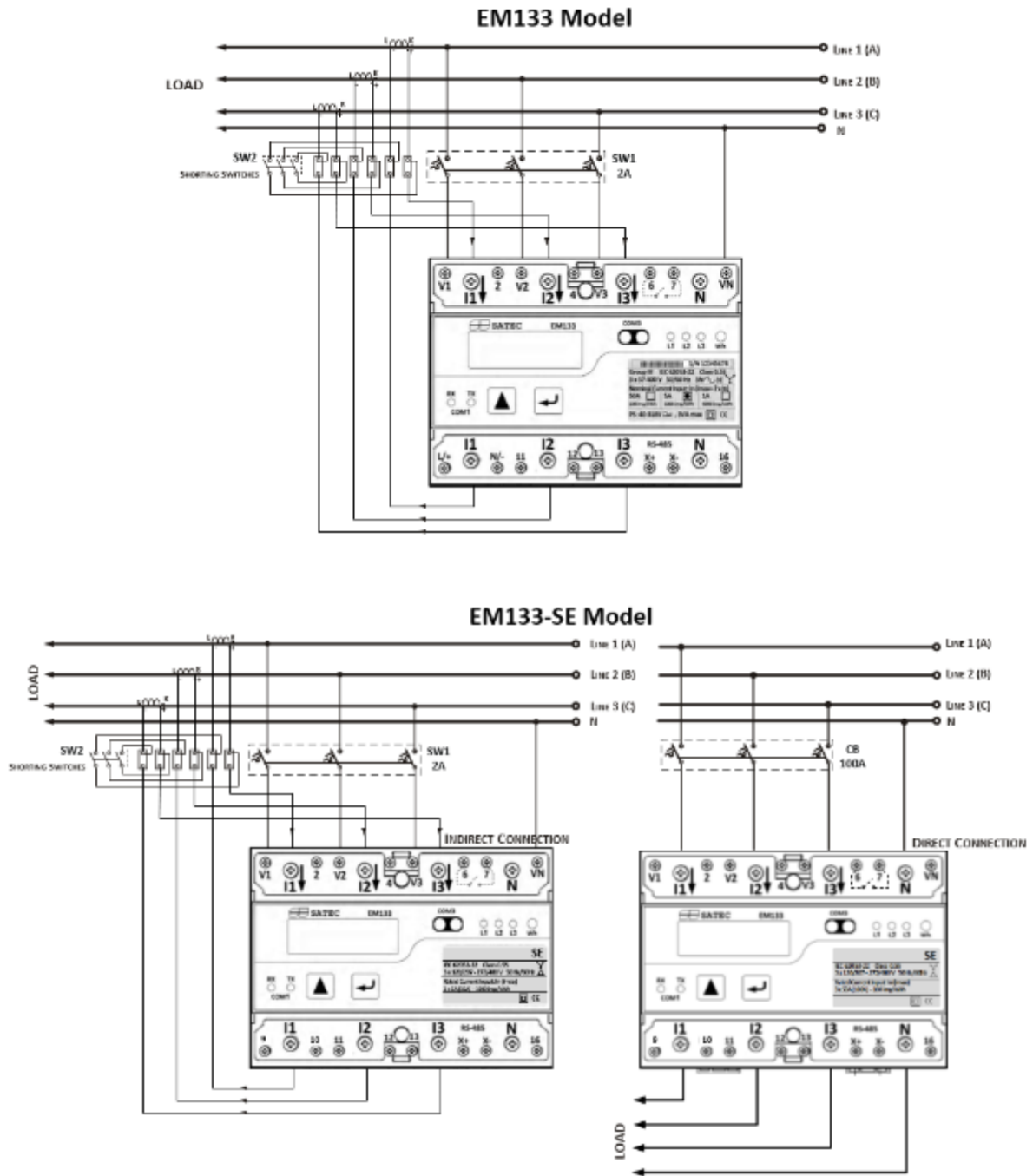


Figure 2-12 3-Wire 2-Element Delta Direct Connection Using 2 CTs (Wiring Mode = 3dir2)



**Figure 2-13 4-Wire Wye 3-Element Direct Connection Using 3 CTs (Wiring Mode = 4LL3 or 4Ln3)**

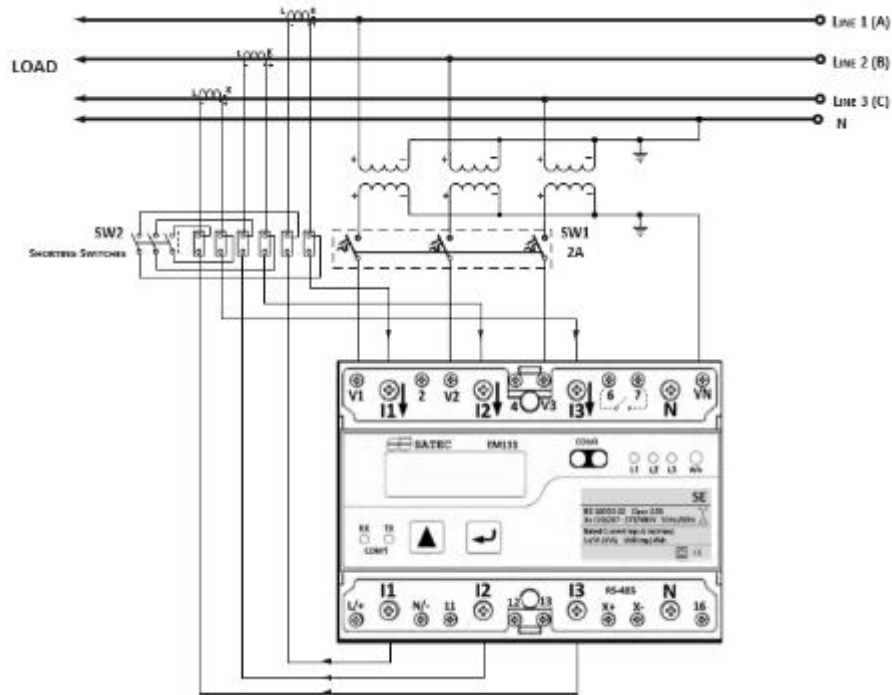


Figure 2-14 4-Wire Wye 3-Element Connection Using 3 PTs, 3 CTs (Wiring Mode = 4LL3 or 4Ln3)

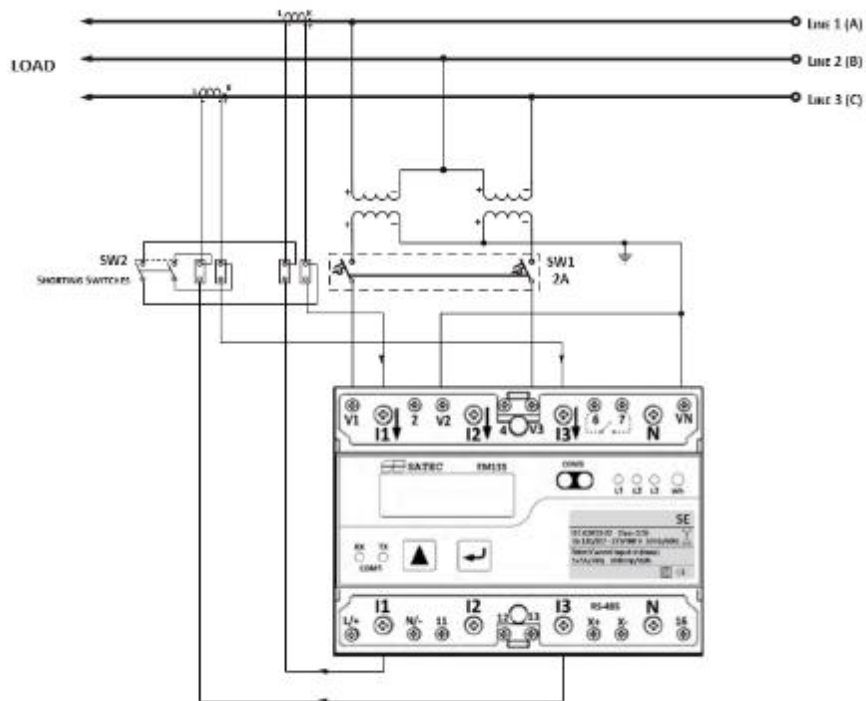
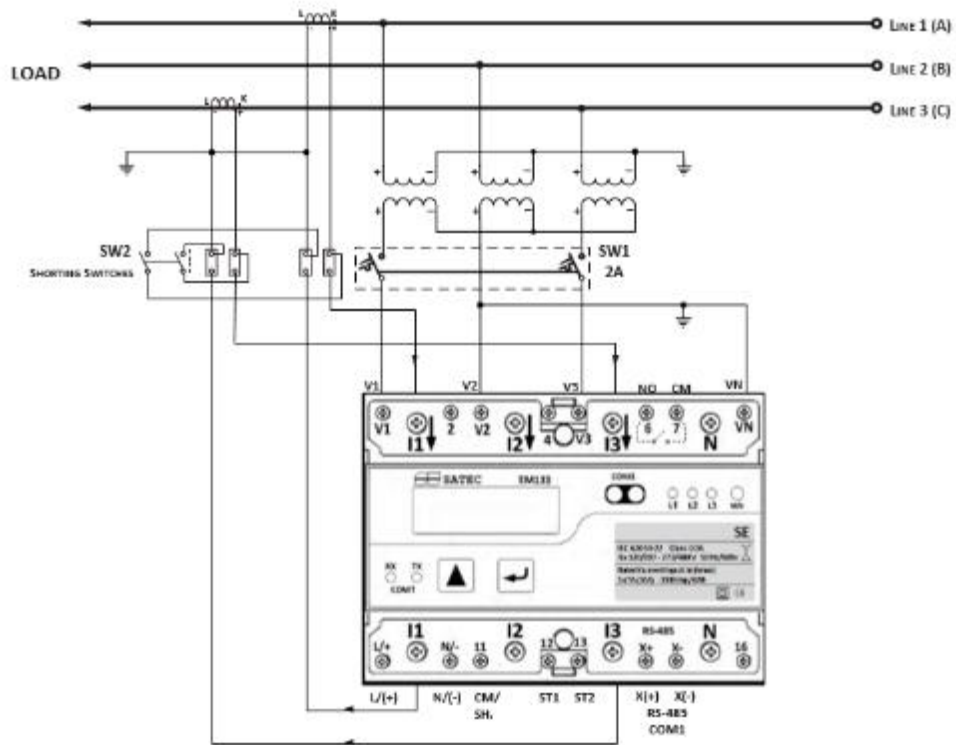
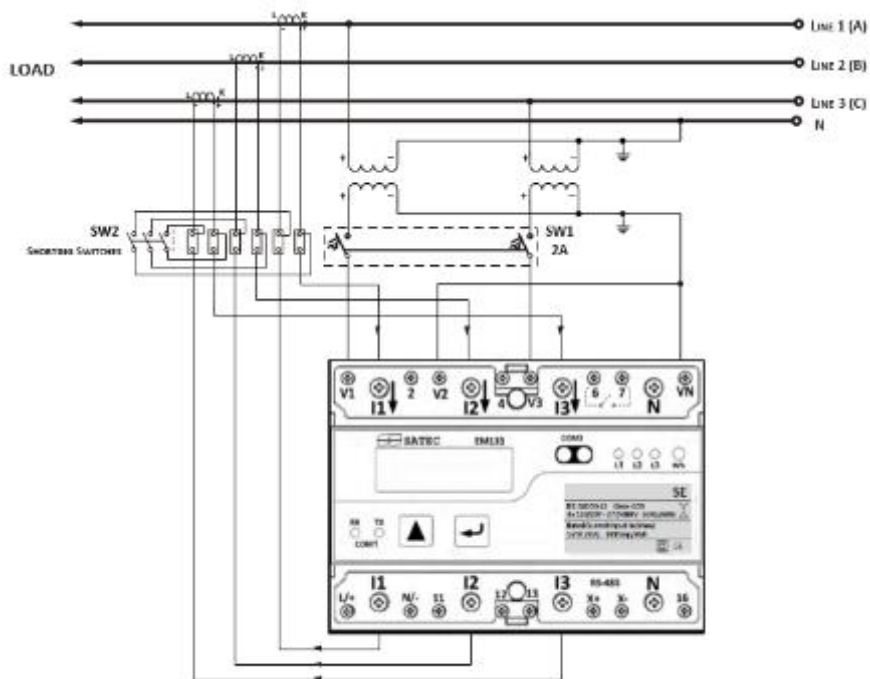


Figure 2-15a 3-Wire 2-Element Open Delta Connection Using 2 PTs, 2 CTs (Wiring Mode = 3OP2)



**Figure 2-15b 3-Wire 2-Element Open Delta Connection Using 3 PTs, 2 CTs (Wiring Mode = 3OP2)**



This configuration provides accurate power measurements only if the voltages are balanced.

**Figure 2-16 4-Wire Wye 2 1/2-Element Connection Using 2 PTs, 3 CTs (Wiring Mode = 3LL3 or 3Ln3)**

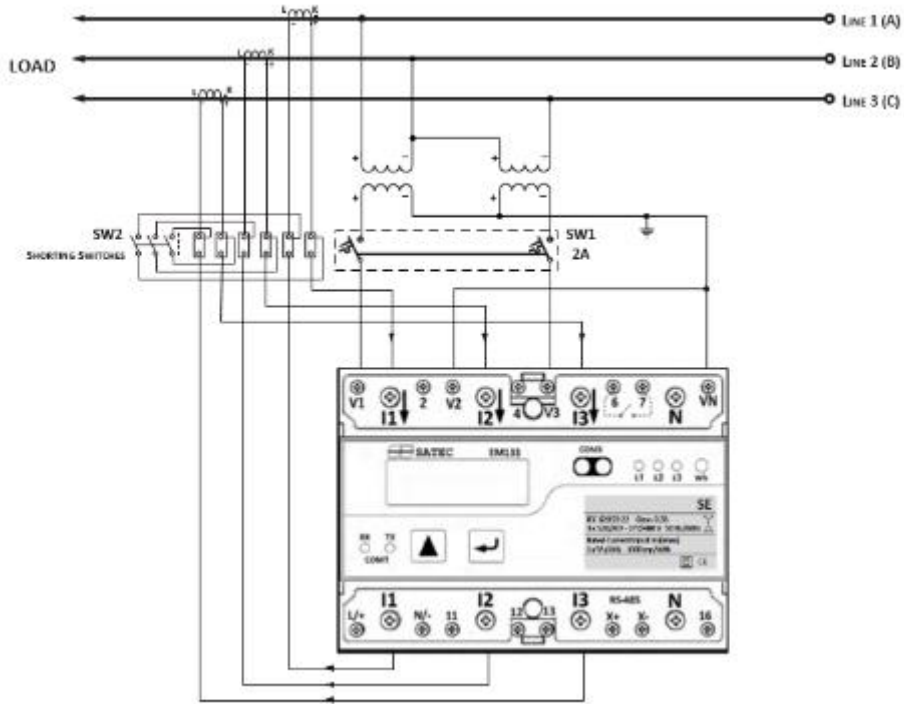


Figure 2-17 3-Wire 2½-Element Open Delta Connection Using 2 PTs, 3 CTs (Wiring Mode = 3OP3)

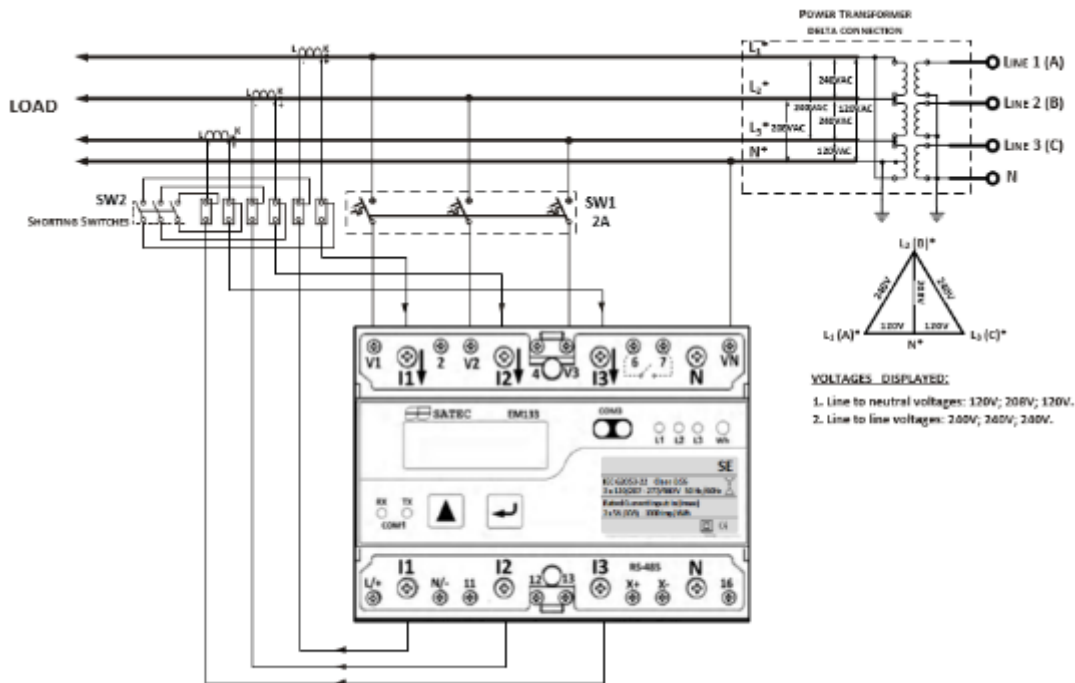
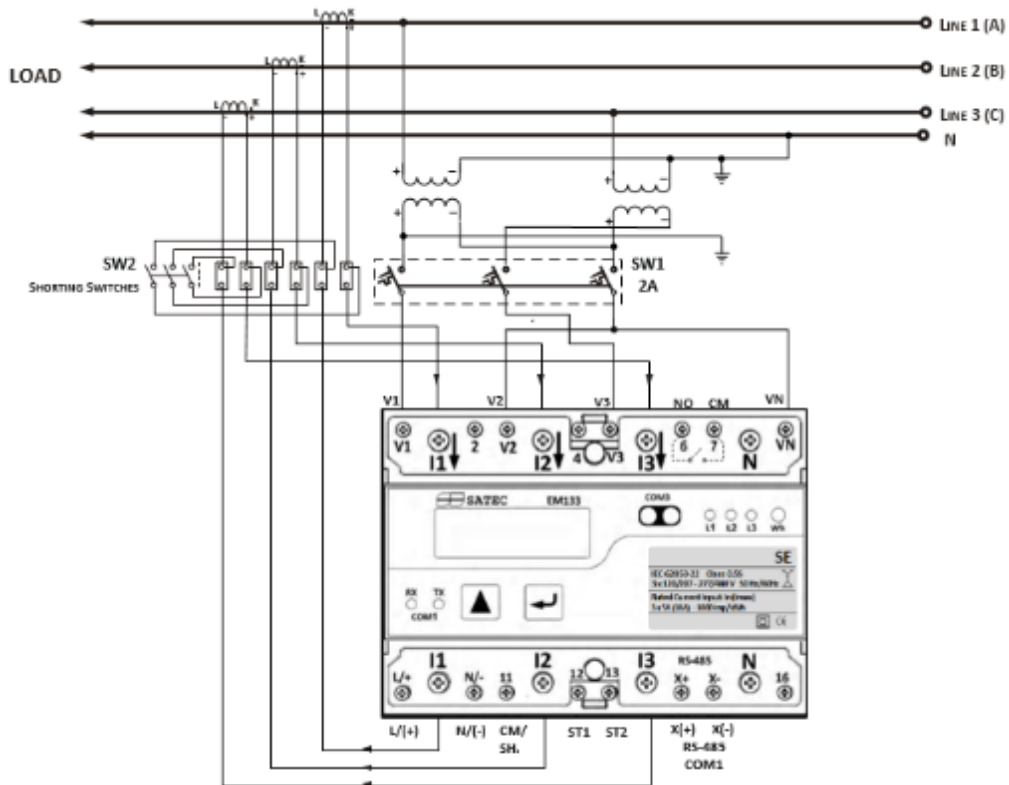


Figure 2-18 4-Wire 3-Element Delta Direct Connection Using 3 CTs (Wiring Mode = 4LL3 or 4Ln3)





**Figure 2-19 3-Wire 2 1/2-Element Broken Delta Connection Using 2 PTs, 3 CTs (Wiring Mode = 3bLn3 or 3bLL3)**

## 2.5 Battery Replacement

### WARNING!



Only qualified personnel familiar with the instrument and its associated electrical equipment must perform the RTC battery backup replacement. The battery replacement must be performed while equipment power supply is "ON"

To replace the CR2032 RTC battery:

- 1) Remove the EM13X Series cover
- 2) Remove the old battery by lifting up the battery holder retractable tab.
- 3) Place the new CR2032 battery into the battery holder while holding up the battery holder retractable tab in such a way that the (+) battery pole is toward the battery holder, as shown in Figure 2-7.

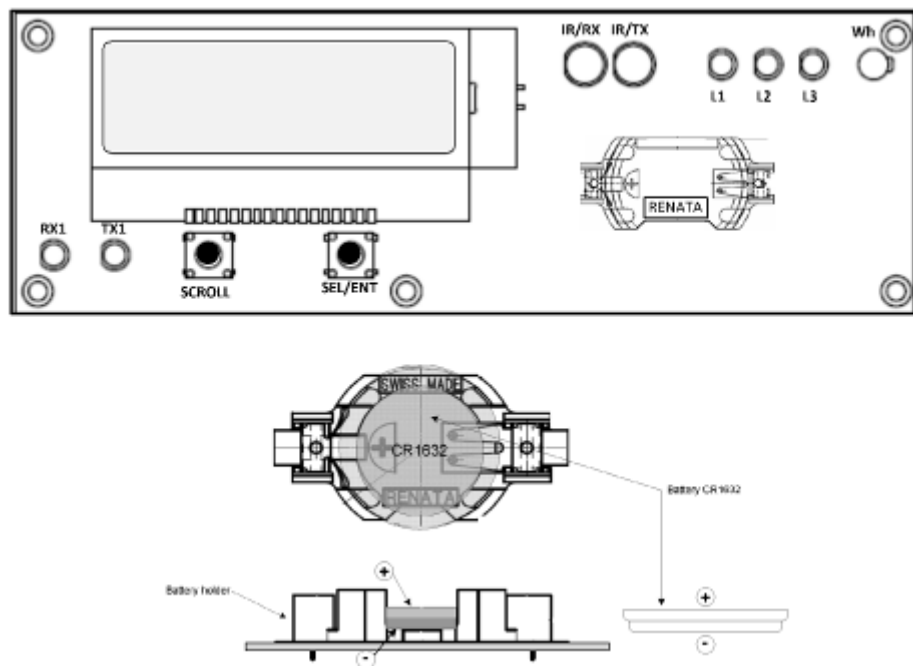


Figure 2-7 EM13X Series Battery Replacement

## 2.6 I/O Connections



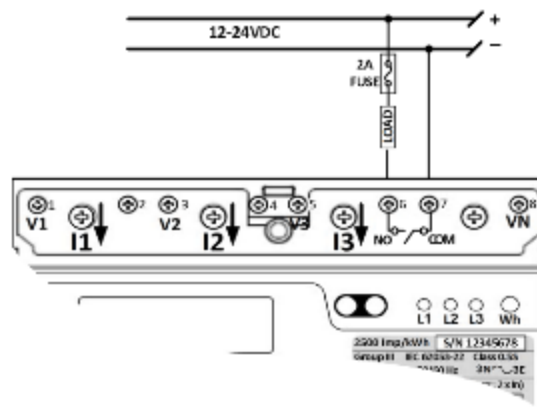
Before I/O Module installation ensure that all incoming power sources are shut OFF. Failure to observe this practice can result in serious or even fatal injury and damage to equipment.

For I/O ratings, see [Technical Specifications](#) in Appendix A.

### 2DI/1RO Standard

#### Relay Output

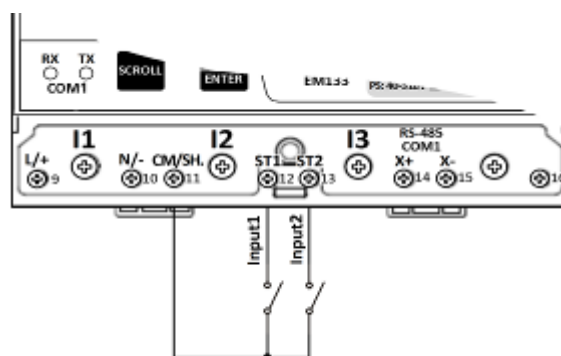
The EM13X Series basic provides one dry contact relay (SSR FORM A) for energy pulsing, alarms or remote control



**Figure 2-8 EM13X Series Relay output connection**


#### Digital Inputs

Two optically isolated status inputs are provided for status monitoring, pulse counting, external power demand period, and time synchronization.



**Figure 2-9 EM13X Series Digital Input connections**

### 4DI/2RO Module

 Before I/O Module installation ensure that all incoming power sources are shut OFF. Failure to observe this practice can result in serious or even fatal injury and damage to equipment.

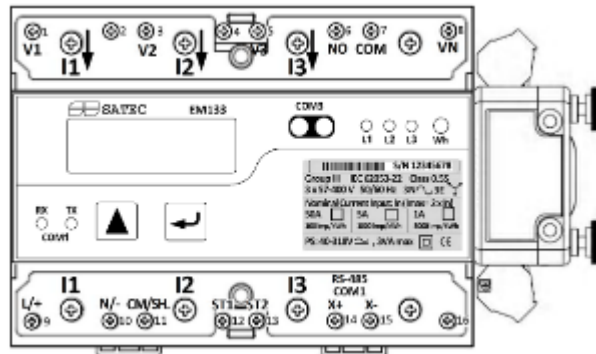


Figure 2-10 4DI/2RO Module Assembly

### Relay Outputs

There are two relay outputs provided for energy pulsing, alarms, or remote control.

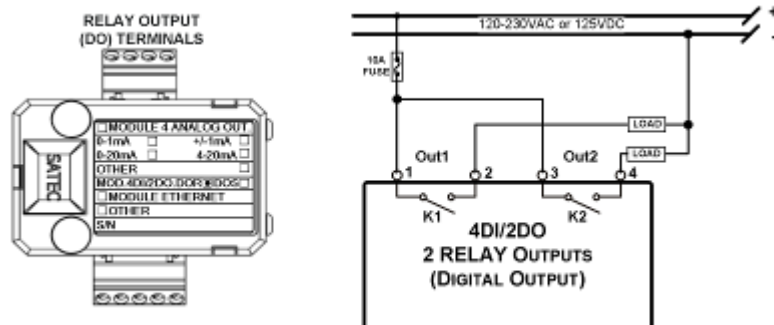


Figure 2-11 Relay Output Connection

### Digital Inputs

Four optically isolated status inputs are provided for status monitoring, pulse counting, external power demand period, and time synchronization.

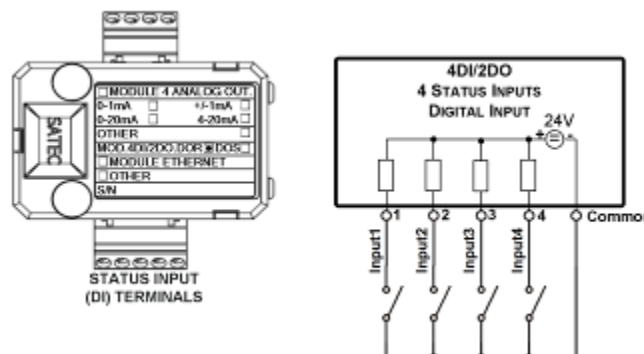
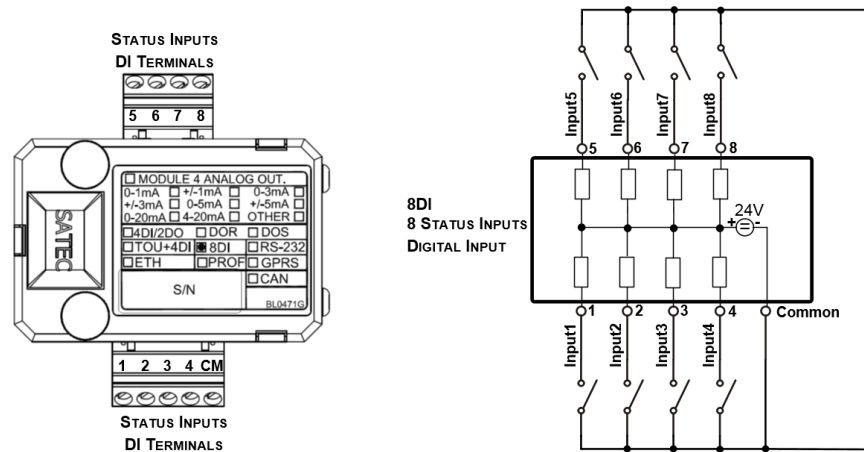


Figure 2-12 4 DI/2DO - Digital Input Connection

## 8 DI module

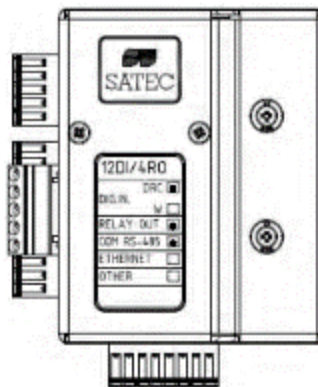
Eight optically isolated status inputs are provided for status monitoring, pulse counting, external power demand period, and time synchronization



**Figure 2-13 8 DI - Digital Input Connection**

## 12DI/4RO Module

The 12DI/4RO module can be equipped with optional communication port COM2 – ETHERNET or RS-422/485.



**Figure 2-14 12DI/4RO Module**

## Relay Outputs

There are four electro-mechanic relay outputs provided for energy pulsing, alarms, or remote control.

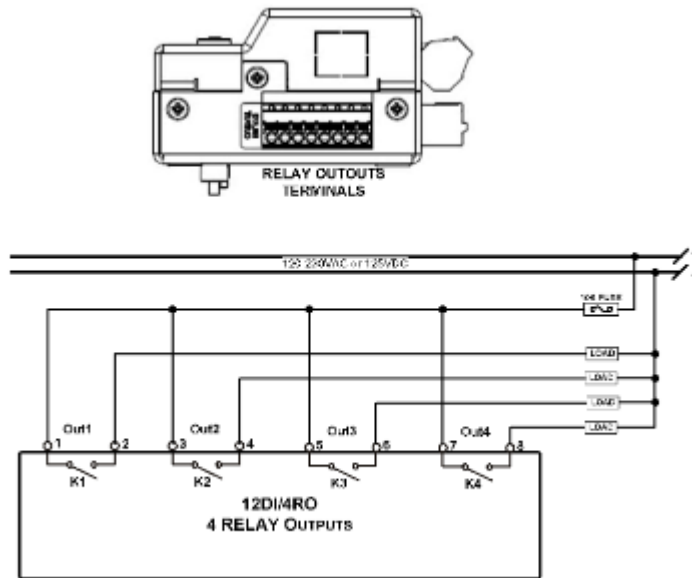


Figure 2-15 Relay Output Connection

### Digital Inputs

12 optically isolated status inputs are provided for status monitoring, pulse counting, external power demand period, and time synchronization.

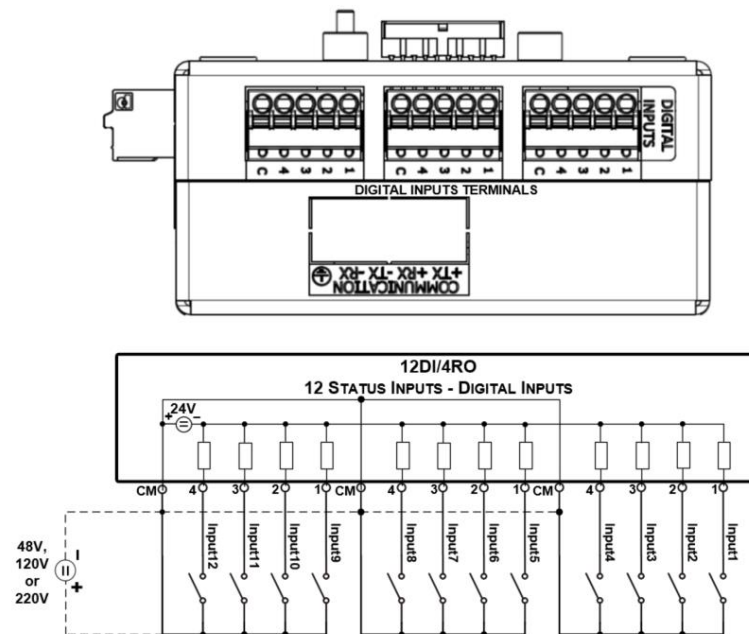
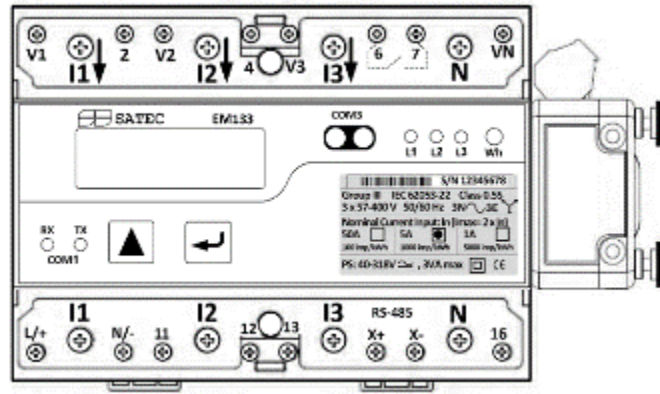


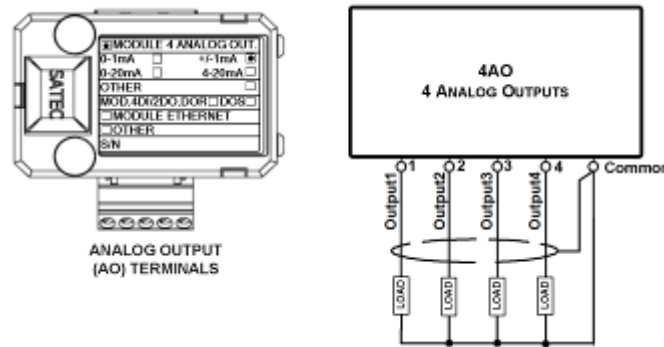
Figure 2-16 12 Digital Input Connection

### 4AO Module - Analog Outputs


The 4AO module has four optically isolated analog outputs with an internal power supply and current output options of 0-20 mA and 4-20 mA (current loop load of up to 500 Ohm), 0-1 mA and  $\pm 1$  mA (2mA 100% overload, current loop load of up to 5 kOhm).



**Figure 2-17 4AO Module Assembly**



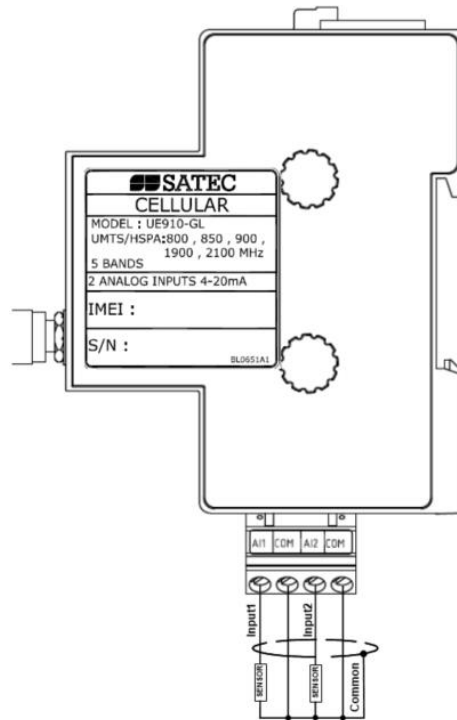
**Figure 2-18 Analog Output Connection**

 It is recommended to connect unused Analog output channels to Common terminal.

→ The 4AO module TERMINAL is for use only with equipment which has no live parts which are ACCESSIBLE  
 The RATING of the insulation of the external equipment for use with the 4AO module, shall comply according to Installation Category III for insulation to be suitable for SINGLE FAULT CONDITION  
 The external equipment TERMINAL connection type is normally terminal block for wire size 14 AWG (up to 1.5 mm<sup>2</sup>)  
 The type of equipment that might be connected to the TERMINAL is:  
 Programmable Logic Controller for automation – PLC  
 Digital or Analog meter

## 2G/3G+2 AI Module – 2 x Analog Inputs

The 2G/3G+2AI module has two optically isolated analog inputs with an internal power supply and current input measurement of 4-20 mA (current loop load of up to 500 Ohm), that could be interfaced to a 4-20mA Temperature sensor.





## 2.7 Communications Connections



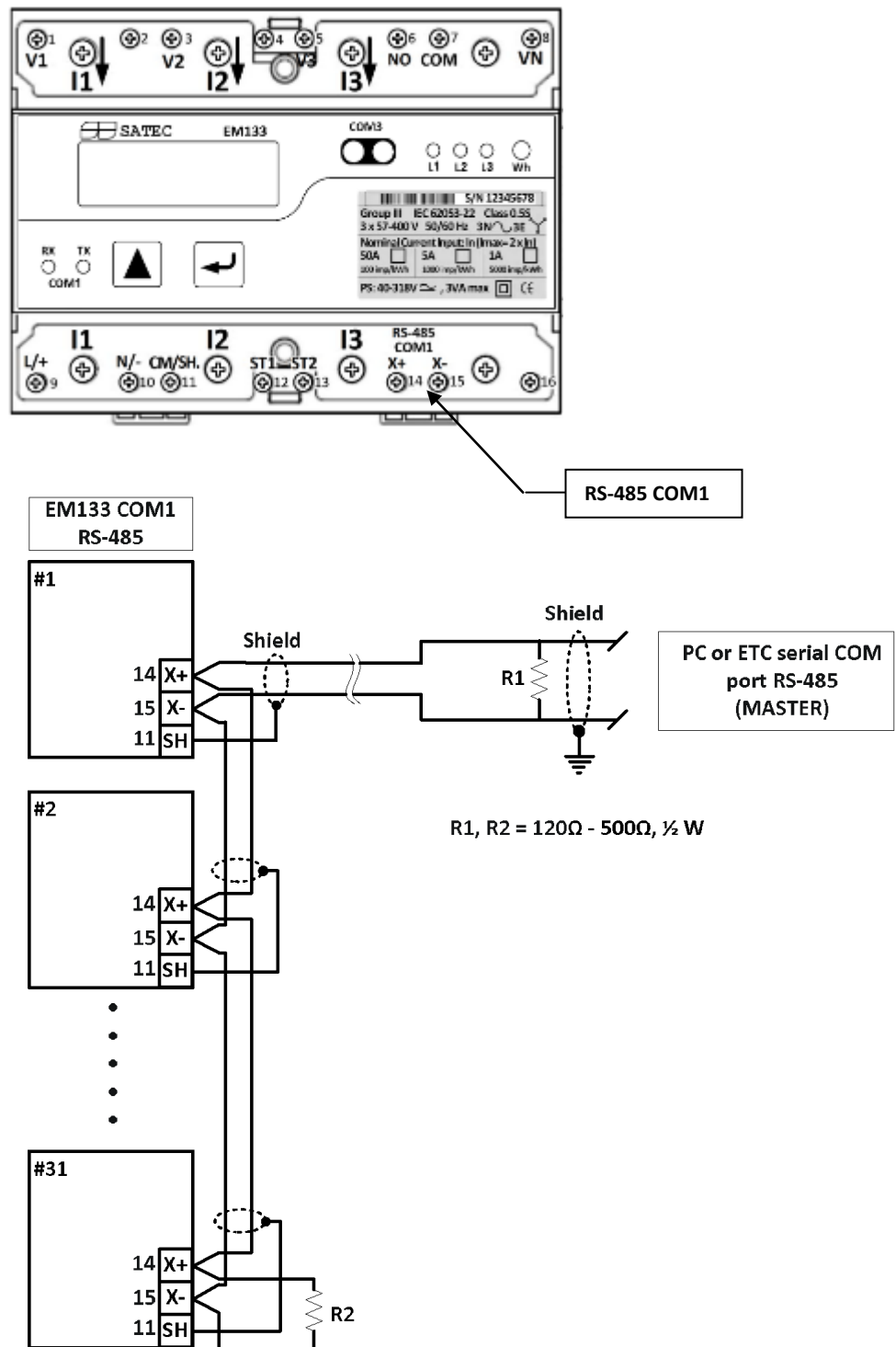
Before installing the Communication Module, ensure that all incoming power sources are shut OFF. Failure to observe this practice can result in serious or even fatal injury and damage to equipment.

Several communication options are available for the EM13X Series:

- COM1 (standard): RS-485
- COM2 (optional module):
  - Ethernet 10/100BaseT
  - PROFIBUS DP
  - CANopen
  - RS-232 or RS-422/485
  - 2G/3G/4G
  - 2G/3G+2AI
  - RF
- COM3 (standard): IR

A full description of the communication protocols is found in the EM13X Series protocol guides that come with your meter.

### RS-485 Connection



**Figure 2-19 COM1 RS-485 2-Wire Connection**

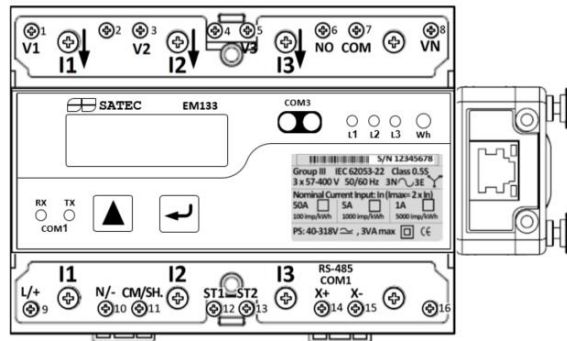
Communication cable Specification: Shielded, #22AWG.

**Note:** pay attention to GND connection (SH->GND).

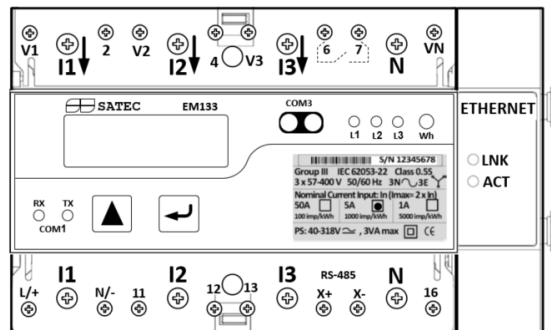
## ETH module – COM2 Ethernet Connection

The EM13x ETHERNET module can be used in three different modules form factors:

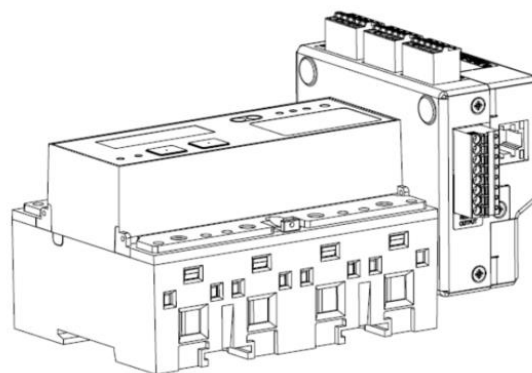
- Regular ETHERNET Module that can be used in PM13x & EM13x
- DIN Rail ETHERNET module that can only be used in EM13x.
- Combined with 12DI/4DO module that can be used in PM13x & EM13x



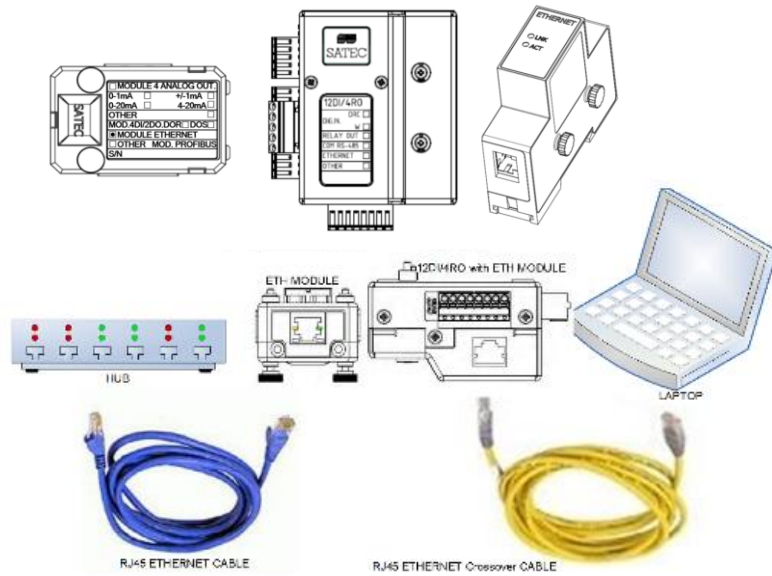
**Figure 2-20a Regular Ethernet module**



**Figure 2-21b DIN Rail Ethernet module**



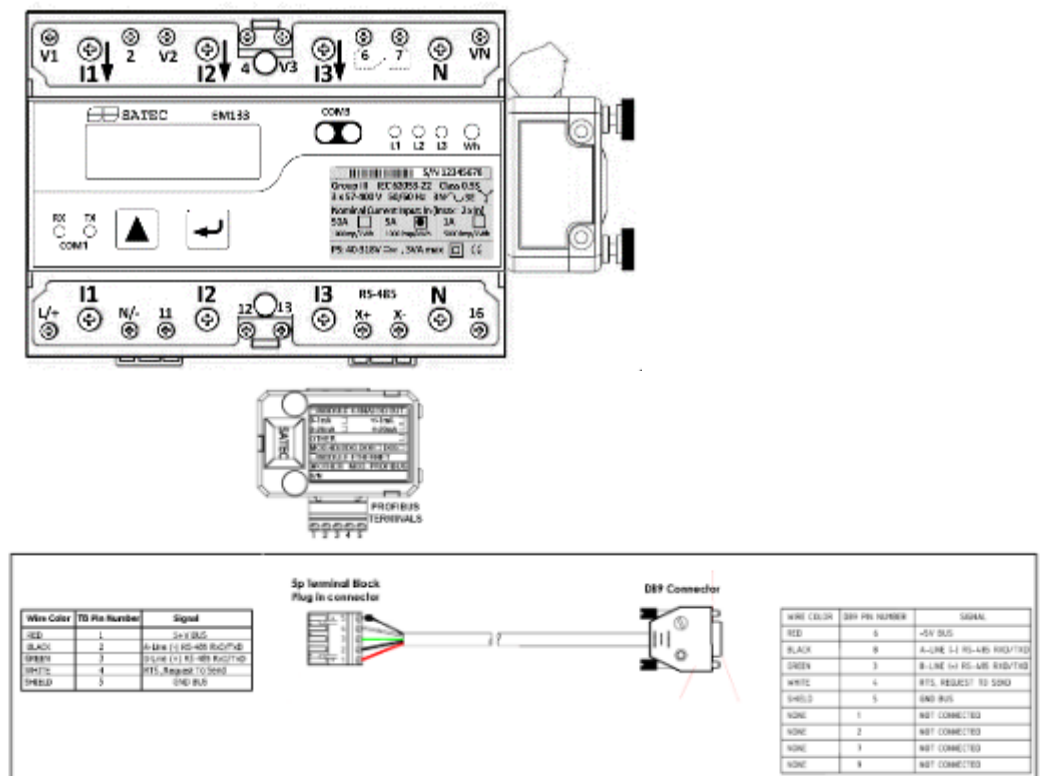
**Figure 2-22c 12DI/4DO Combined Ethernet module**



**Figure 2-23 COM2 Ethernet Connection**

⇒ The ETH module TERMINAL is for use only with equipment which has no live parts which are ACCESSIBLE  
 The RATING of the insulation of the external equipment for use with the ETH module, shall comply according to Installation Category III for insulation to be suitable for SINGLE FAULT CONDITION  
 The external equipment TERMINAL connection type is RJ-45  
 The type of equipment that might be connected to the TERMINAL is:  
 Personal Computer – PC or LAPTOP  
 10/100Base-T LAN HUB and/or Switch

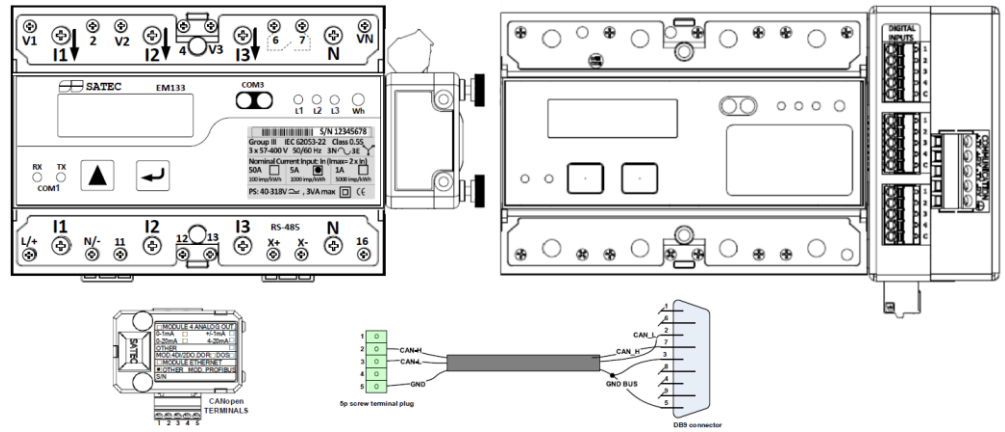
### PRO module – COM2 PROFIBUS Connection



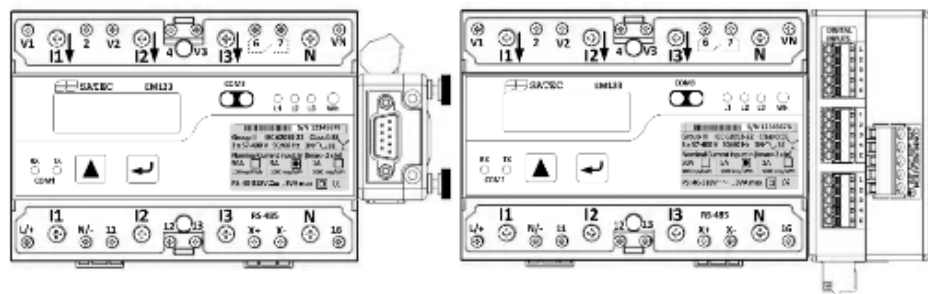
**Figure 2-24 COM2 PROFIBUS Connection**

⇒ The PRO module TERMINAL is for use only with equipment which has no live parts which are ACCESSIBLE  
 The RATING of the insulation of the external equipment for use with the PRO module, shall comply according to Installation Category III for insulation to be suitable for SINGLE FAULT CONDITION  
 The external equipment TERMINAL connection type is DB9  
 The type of equipment that might be connected to the TERMINAL is:  
 Programmable Logic Controller for automation – PLC

### CANopen module – COM2 CANopen Connection



### RS-232/422-485 module – COM2 Connection



No	DB9 Male connector pin PM130-plus side		DB9 Female connector pin PC or Master side	
	Pin No	Pin ID	Pin No	Pin ID
1	2	Tx	2	Rx
2	3	Rx	3	Tx
3	5	GND	5	GND

Figure 2-25 COM2 RS-232 connection

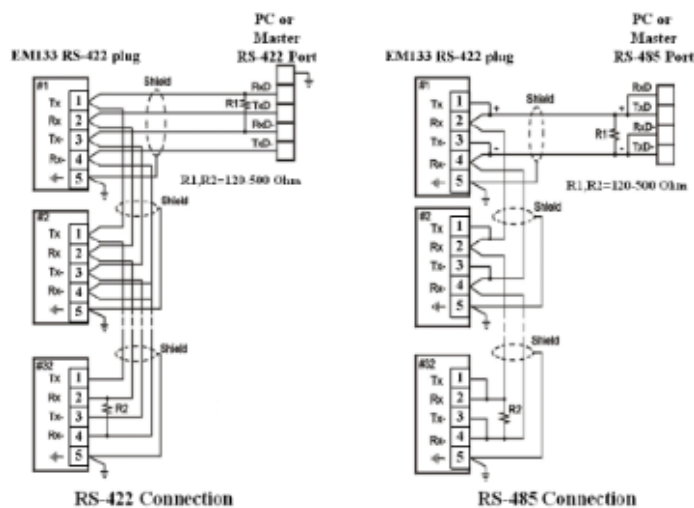


Figure 2-26 COM2 RS-422/485 connection

⇒ The RS-232/422-485 module TERMINALS are for use only with equipment which has no live parts which are ACCESSIBLE  
The RATING of the insulation of the external equipment for use with The

RS-232/422-485 module, shall comply according to Installation Category III for insulation to be suitable for SINGLE FAULT CONDITION. The external equipment TERMINAL connection type is normally terminal block for wire size 14 AWG (up to 1.5 mm<sup>2</sup>) – RS-422/485 port and DB9 male-to-female cable more than 22 AWG (0.3mm<sup>2</sup>). The type of equipment that might be connected to the TERMINAL is: Personal Computer – PC or LAPTOP.

## Connecting a Cellular module

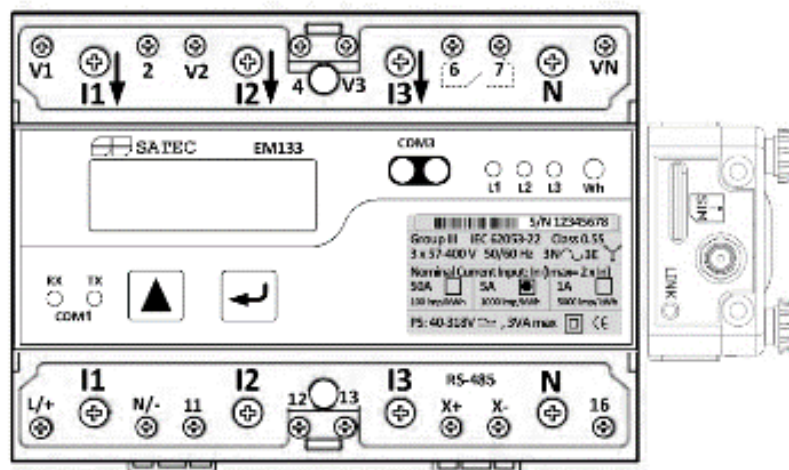
The EM13x series can be equipped with 2G/3G/4G module for remote communication using public cellular network to a remote MODBUS/TCP server.

It consists of three types of Cellular module:

- 1) 2G/3G module, mainly for GSM network (Regular or DIN rail form factor)
- 2) 2G/3G+2AI module, including 2 x Analog Inputs 4-20mA (DIN Rail form factor)
- 3) 4G LTE module for following service providers (Regular or DIN rail form factor):
  - Verizon (US), using Module 4G Verizon LE910-SV V2
  - AT&T (US), using Module 4G AT&T LE910-NA V2
  - Telstra (AU), using Module 4G Telstra LE910-AU V2
  - Europe (EU), using Module 4G Europe LE910-EU V2

The EM13x Cellular module can be used in two different form factors:

- Regular Cellular Module that can be used in PM13x & EM13x
- DIN Rail Cellular module that can only be used in EM13x.



**Figure 2-27a COM2 2G/3G/4G Regular module Connection**

**SIM  
Cartridge**

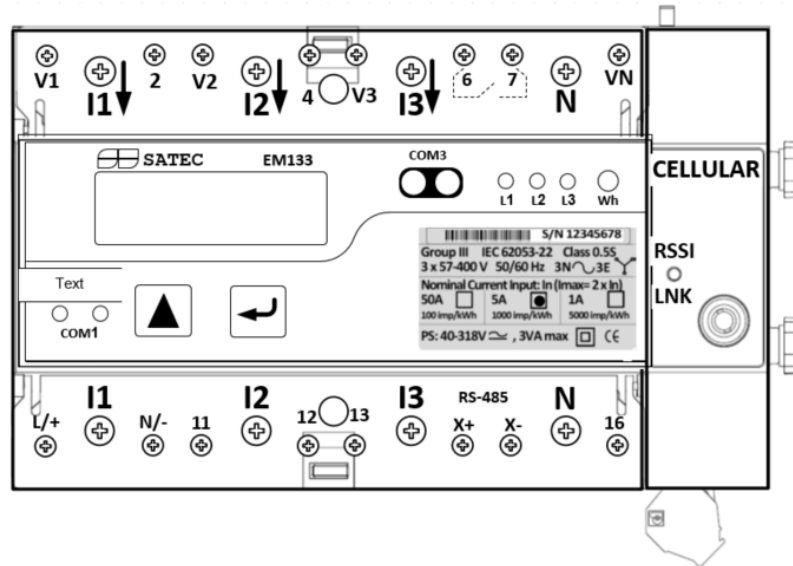


Figure 2-28b COM2 2G/3G+2AI DIN Rail module Connection

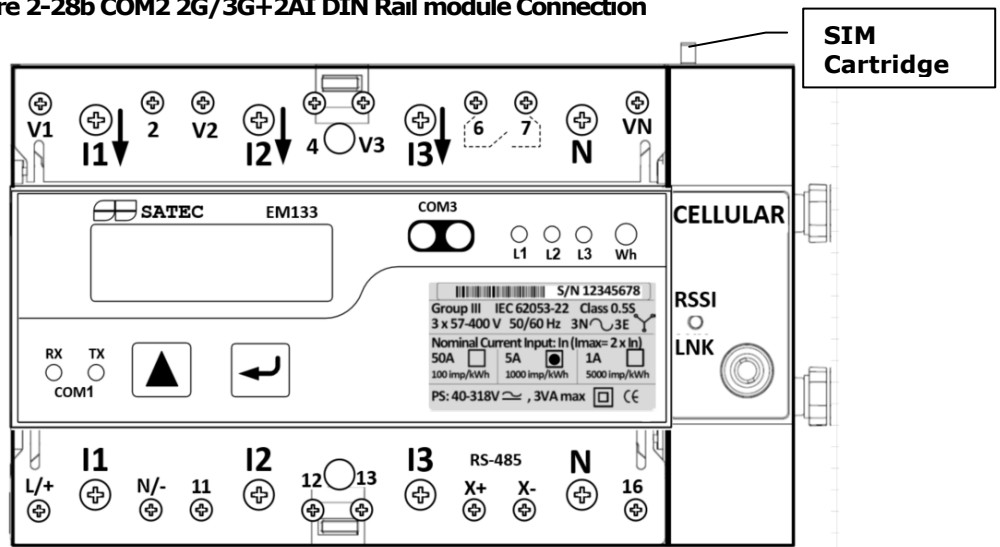


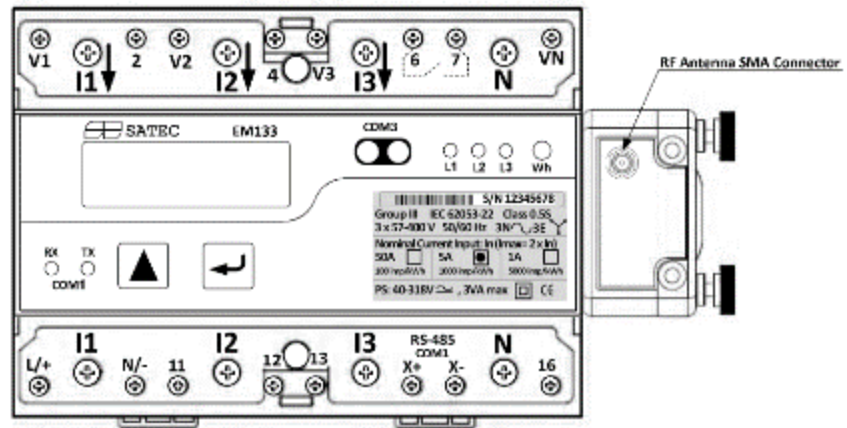
Figure 2-29b COM2 2G/3G/4G DIN Rail module Connection

⇒ The Cellular SIM must not have any incoming voice call. The customer must require from the Service Provider for DATA services only. The Cellular module can be equipped with two different antennas: internal Antenna for installation into plastic closet or no-metallic environment. For metallic installation use external antenna.

See [Setting Up GPRS](#) in Chapter 5 for information on configuring Cellular communications in your meter.



### Connecting an RF module

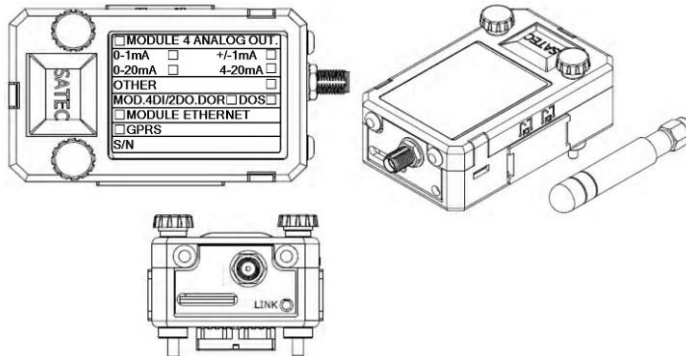


**Figure 2-30 COM2 RF module Connection**

⇒ The RF modem module can be equipped with two different antennas: internal Antenna for installation into plastic closet or no-metallic environment. For metallic installation use external antenna

### Connecting a WiFi module

A WiFi module can be connected to the meter COM2 port to provide communications with the remote MODBUS/TCP server via a WiFi



See [Setting Up WiFi Network](#) in Chapter 5 for information on configuring WiFi communications in your meter.

## Chapter 3 Using Front Display

This chapter provides EM13X Series SMART MULTIFUNCTION METER front panel information and operating procedures.

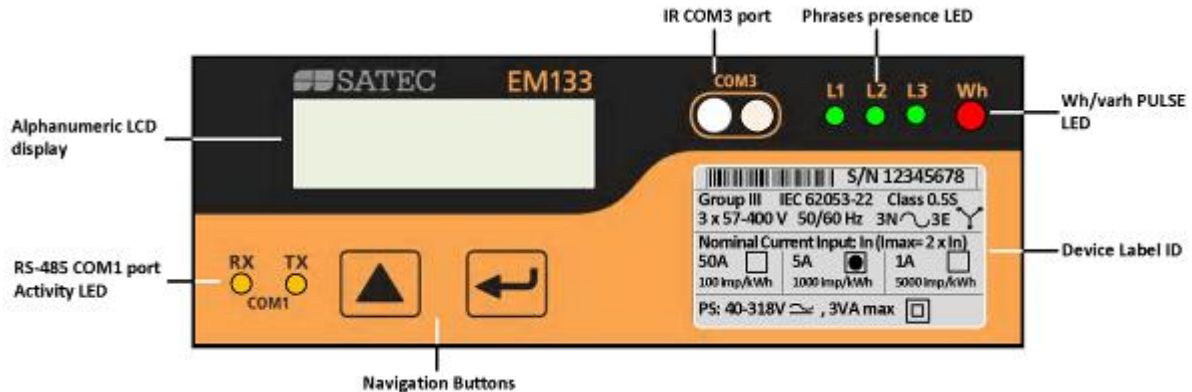


Figure 3-1: EM13X Series Unit

### Energy Pulse LED

The EM13X Series has a red "Energy Pulse" LED. It flashes at a constant rate when a load is applied to the meter.

There are two modes of LED operation:

- **NORMAL mode:** the LED pulses indicate imported Wh at a rate of 1,000 pulses per kWh
- **TEST mode:** the LED pulses indicate either imported Wh, or imported (inductive) varh at a rate of 10,000 pulses per kWh/kvarh

The energy test mode can be enabled through the Device Options setup. When in test mode, the energy and demand accumulators do not account for consumed energy.

### COMPort Activity LEDs

The meter has two yellow LEDs "RX" and "TX", which indicate activity on the COM1 communication port. The LEDs flash when the port is receiving or transmitting data.

### VOLTAGES LEDs

The meter has three green LEDs "L1", "L2" and "L3", which indicate voltage measurement input presence. When LEDs are "ON", that means that the voltage measurement inputs exist in the meter

### Navigation Buttons

The EM13X Series is provided with two push buttons that are normally used to navigate between different measurement displays.

The "UP" and "DOWN" function of buttons changes depending on what operating mode the display is in. In programming mode, the buttons access the device setup menus where the default factory-set device settings can be changed.

## 3.1 Display Operations



The EM13X Series has a high-contrast graphical LCD display with backlight for local data read outs, meter setup and servicing.

The display operates in two modes:

- Multi-page data display mode with Auto-Scroll feature allows you to scroll through display screens and pages to view various billing, instrumentation and status data.
- Programming mode allows you to enter menu-driven device setups for inspecting and changing factory set meter parameters, or resetting maximum demands, counters and device diagnostics messages. The display is normally updated once per second except of the clock display where the update rate changes to twice per second.

### Navigation Buttons

The EM13X Series is provided with two navigation buttons,

 **SELECT/ENTER** button and  **SCROLL** button.

You can perform three types of actions with each button:

- Short press, or “press and release”
- Long press, or “press and hold for 1 to 2 seconds”
- Extended press, or “press and hold for 5 seconds or longer”

The function of each button changes depending on what operating mode the display is in.

The **SCROLL** button operates once it is briefly pressed. It has two functions:

- In data display mode, it scrolls through the display pages.
- In programming mode, it scrolls through the menu items and allows changing a selected digit when entering numbers.

The **SELECT/ENTER** button normally operates once it's released. The button function changes depending on the time the button is pressed:

- In data display mode, when pressed briefly and released, it scrolls through the display views; a long press for more than 5 seconds switches to programming mode.
- In programming mode, when pressed briefly and released, it moves from one menu item to another; a long press for one second selects a highlighted menu item allowing to enter a submenu or to store a changed item.

In data display mode, when the **SCROLL** and **SELECT/ENTER** buttons are briefly pressed together and then released, the current display returns to the start page; in some pages, an extended press for more than 5 seconds is used as a “shortcut” for immediate entering a specific programming menu.

## Navigating in Data Display Mode

The following table gives a summary of the button operations in data display mode.

Button	Press	Operations
SCROLL	Short press	Scroll through pages
SELECT/ENTER	Short press	Scroll through displays
SELECT/ENTER	Long press	Enter programmed parameter
SELECT/ENTER	Extended press	Enter programming mode

The EM13X Series provides 7 different multi-page data displays. See [Data Displays](#) for the full displays list and enumeration.

## Display Features

The EM13X Series display has a number of programmable features that can be disabled, enabled and adjusted via the meter Display Setup (see [Display Setup](#) in Chapter 5).

### Backlight

A short press on any button while the display backlight is off switches the backlight on.

The backlight stays on as long as you selected in the display setup and then dims to conserve power. The backlight time is factory set to 1 minute and can be programmed from 1 to 10 minutes. You can temporarily set the backlight to continuous operation if you need to work in dark for more time.

### Auto-Return

If the Auto-Return feature is enabled and no button is pressed for the programmable Auto-Return interval (1 to 30 minutes for data displays; fixed at 5 minutes for setup menus), the display automatically returns to the default page from any other data display or a setup menu.

If the Auto-Scroll feature is enabled, the display immediately enters the auto scroll sequence.

### Auto-Scroll

If the Auto-Scroll feature is enabled, the data display automatically scrolls through all pages of all data displays that are included into the programmable auto-scroll sequence. The scroll interval is adjustable in the range of 2 to 30 seconds. The scroll sequence may include all or only selected displays.

The display automatically enters auto scrolling if no button is pressed for the Auto-Return interval when the Auto-Return feature is enabled or in 1 minute if this feature is disabled. In the last case, the scroll sequence is restored from the point where it was interrupted.

To stop auto scrolling, press briefly any button if the backlight is on; else press briefly any button twice since the first press only sets the backlight on and does not affect auto scrolling.

Auto-Scroll is not operational in TEST mode.

## Measurement Units

The following table shows the display resolution for common displayed quantities. All measured data is displayed in primary units.

Measured Quantity	Voltage Connection	Units and Display Resolution
Energy		kWh, kvarh, kVAh with one decimal place. The number of digits is programmable (see <a href="#">Device Options and Mode Control</a> in Chapter 5).
Power	Direct (PT = 1.0)	kW, kvar, kVA with three decimal places
	Transformer (PT>1.0)	MW, Mvar, MVA with three decimal places
Voltage	Direct (PT = 1.0)	Volts with one decimal place
	Transformer (PT>1.0)	Kilovolts with three decimal places
Current		Amperes with two decimal places


## 3.2 Data Displays

The EM13X Series has 7 multi-page data displays listed in the following table.

Display Sequence	Display type	Display Contents
1	Billing/TOU reg.	Energy billing period data
2	TOU/Max. DEMAND	Max. DMD Power billing period data
3	Energy	Total and Phase Energy data
4	MAX. DEMAND	Engineering maximum demands
5	Measurement	Instrumentation data
6	Phase Rotation	Phase, I/O and Counter data
7	Diagnostics	Device diagnostics messages and Device service data

### TEST Mode Data Display

The TEST data display is shown in TEST mode in place of the billing period data displays, "NORM" is replaced by "TEST". See [Device Options and Mode Control](#) in Chapter 5 on how to enter the meter TEST mode.

DISPLAY	Description
	TEST mode display: test LED pulse rate in secondary Wh/imp, test kWh and kvarh energy registers readings in primary units with an extended 0.001 kWh resolution.

### Billing Period Energy Data Displays

The EM13X Series provides billing period data displays for energy and general purpose volume data as m<sup>3</sup>, cf or Ccf calculated using Digital Input for water and/or gas meter application.

Only registers you selected in the billing/TOU register setup and tariff rates listed in the TOU daily profiles are included (see [Configuring Billing/Tariff Registers](#) and [Configuring the Daily Tariff Schedule](#) in Chapter 5).

The following example demonstrates the present billing period displays for two configured billing registers (kWh imported and kvarh imported) and for three active tariff rates. The actual register contents in your installation may be different depending on your selection of register sources.

<b>DISPLAY</b>	<b>Description</b>
Reg 1 Imp 725 kWh	Total Import Active energy data. Billing period according to TOU predefined profile (Reg1 for TOU active energy and Reg2 for TOU reactive energy are predefined TOU/Register factory setup, can be changed by user, see <a href="#">Configuring Billing/Tariff Registers</a> and <a href="#">Configuring the Daily Tariff Schedule</a> in Chapter 5)
Reg 1/T1 Imp 517 kWh	Tariff 1 Import Active energy data.
Reg 1/T2 Imp 114 kWh	Tariff 2 Import Active energy data.
Reg 1/T3 Imp 94 kWh	Tariff 3 Import Active energy data.
Reg 2 Imp 221 kvarh	Total Import Reactive energy data.
Reg 2/T1 Imp 165 kvarh	Tariff 1 Import Reactive energy data.
Reg 2/T2 Imp 35 kvarh	Tariff 2 Import Reactive energy data.
Reg 2/T3 Imp 21 kvarh	Tariff 3 Import Reactive energy data.
	Single Phase billing data <sup>1</sup> Total Import Phase 1 active energy data
	Tariff 1 Import Phase 1 active energy data.

<sup>1</sup> Only from S/W V12.2.1

	Tariff 2 Import Phase 1 active energy data.
	Tariff 3 Import Phase 1 active energy data.
	Total Import Phase 2 active energy data
	Tariff 1 Import Phase 2 active energy data.
	Tariff 2 Import Phase 2 active energy data.
	Tariff 3 Import Phase 2 active energy data.
	Total Import Phase 3 active energy data
	Tariff 1 Import Phase 3 active energy data.
	Tariff 2 Import Phase 3 active energy data.
	Tariff 3 Import Phase 3 active energy data.

### **TOU/Maximum Demand Power Data Display**

The following example demonstrates the TOU/Maximum Demand displays for three configured registers (MAX kW imported, MAX kvar imported and MAX kVA imported) and for three active tariff rates. The actual register contents in your installation may be different depending on your selection of register sources.

<b>DISPLAY</b>	<b>Description</b>
----------------	--------------------

<b>DISPLAY</b>	<b>Description</b>
Reg 1 Imp MAX 0.008 kW	Total Import Max. DMD active power data (Reg1 for TOU/Max. DMD active power, Reg2 for TOU/Max. DMD reactive power predefined TOU/Register factory setup, can be changed by user, see <a href="#">Configuring Billing/Tariff Registers</a> and <a href="#">Configuring the Daily Tariff Schedule</a> in Chapter 5)
Reg 1/T1 Imp MAX 0.008 kW	Tariff 1 Import max. active power dmd data.
Reg 1/T2 Imp MAX 0.008 kW	Tariff 2 Import max. active power dmd data
Reg 1/T3 Imp MAX 0.002 kW	Tariff 3 Import max. active power dmd data
Reg 2 Imp MAX 0.003 kvar	Total Import Max. DMD reactive power data
Reg 2/T1 Imp MAX 0.003 kvar	Tariff 1 Import max. reactive power dmd data.
Reg 2/T2 Imp MAX 0.003 kvar	Tariff 2 Import max. reactive power dmd data.
Reg 2/T3 Imp MAX 0.001 kvar	Tariff 3 Import max. reactive power dmd data.
Reg 3 Imp MAX 0 kVA	Total Import Max. DMD apparent power data
Reg 3/T1 Imp MAX 0 kVA	Tariff 1 Import max. apparent power dmd data.
Reg 3/T2 Imp MAX 0 kVA	Tariff 2 Import max. apparent power dmd data.
Reg 3/T3 Imp MAX 0 kVA	Tariff 3 Import max. apparent power dmd data.



**Instrumentation Measurement Maximum Demand Data Display**

Maximum demand displays show engineering maximum demands (not billing maximum demands) for import/export powers, voltages, and currents.

<b>DISPLAY</b>	<b>Description</b>
MAX. DMD P Imp 0.008 kW	Total Import Max. DMD active power data
MAX. DMD P Exp 0 kW	Total Export Max. DMD active power data
MAX. DMD Q Imp 0.003 kvar	Total Import Max. DMD reactive power data
MAX. DMD Q Exp 0 kvar	Total Export Max. DMD reactive power data
MAX. DMD S 0.008 kVA	Total Import Max. DMD apparent power data
MAX. DMD I1 0 A	Max. DMD Phase 1 current data
MAX. DMD I2 0 A	Max. DMD Phase 2 current data
MAX. DMD I3 0 A	Max. DMD Phase 3 current data
MAX. DMD In 0 A	Max. DMD neutral current data
MAX. DMD V1 0 V	Max. DMD Phase 1 voltage data
MAX. DMD V2 0 V	Max. DMD Phase 2 voltage data

MAX. DMD V3                    0 V	Max. DMD Phase 3 voltage data
---------------------------------------	-------------------------------

## Instrumentation Measurement

Instrumentation Measurements represent general instrumentation data you can use while installation and inspecting the meter. Use phase angles displays to check the order of phases when connecting wires to the meter terminals.

DISPLAY	Description
V1                    0 V V2                    0 V	V1 and V2 Phase-to-neutral voltages. Only displayed in 4-wire configurations with a neutral.
V3                    0 V	V2 Phase-to-neutral voltage
V12                    0 V V23                    0 V	Phase-to-Phase voltages.
V31                    0 V	Phase-to-Phase voltages.
I1                    0 A I2                    0 A	Phase currents.
I3                    0 A In                    0 A	Phase currents, neutral current is calculated.
P                    0 kW Q                    0 kvar	Total powers.
S                    0 kVA PF                    0	Total apparent power and total power factor
L1 P                    0 kW L1 Q                    0 kvar	Phase 1 active and reactive power

<b>DISPLAY</b>	<b>Description</b>
L1 S            0 kVA L1 PF            0	Phase 1 apparent power and power factor
L2 P            0 kW L2 Q            0 kvar	Phase 2 active and reactive power
L2 S            0 kVA L2 PF            0	Phase 2 apparent power and power factor
L3 P            0 kW L3 Q            0 kvar	Phase 3 active and reactive power
L3 S            0 kVA L3 PF            0	Phase 3 apparent power and power factor
H1 P            0 kW H1 Q            0 kvar	First Harmonic Total powers.
H1 S            0 kVA H1 PF            0	First Harmonic Total apparent power and total power factor
H1/L1          0 kW H1/L1          0 kvar	First Harmonic Phase 1 active and reactive power
H1/L1          0 kVA H1/L1          0 PF	First Harmonic Phase 1 apparent power and power factor
H1/L2          0 kW H1/L2          0 kvar	First Harmonic Phase 2 active and reactive power
H1/L2          0 kVA H1/L2          0 PF	First Harmonic Phase 2 apparent power and power factor
H1/L3          0 kW H1/L3          0 kvar	First Harmonic Phase 3 active and reactive power

<b>DISPLAY</b>	<b>Description</b>
H1/L3      0 kVA H1/L3      0 PF	First Harmonic Phase 3 apparent power and power factor
V1 THD     0 % I1 THD     0 %	Phase 1 voltage and current THD
V2 THD     0 % I2 THD     0 %	Phase 2 voltage and current THD
V3 THD     0 % I3 THD     0 %	Phase 3 voltage and current THD
I1 TDD     0 % I2 TDD     0 %	Total Demand current Distortion
I3 TDD     0 %	Total Demand current Distortion
V Unb      0 % I Unb      0 %	Voltage and Current unbalance
Freq        0 Hz	Frequency
V1 Ang     0° I1 Ang     0°	Voltage and Current Phase 1 angles (relative to V1 voltage)
V2 Ang     0° I2 Ang     0°	Voltage and Current Phase 2 angles (relative to V1 voltage)
V3 Ang     0° I3 Ang     0°	Voltage and Current Phase 3 angles (relative to V1 voltage)

### Status Inputs and Outputs

<b>DISPLAY</b>	<b>Description</b>
----------------	--------------------

<b>DISPLAY</b>	<b>Description</b>
Phase Rotation: Error	Phase rotation order (Error, Positive, Negative)
DI:           123456 000000	Digital Inputs status
Relays:       123 000	Relays control status
Counter 1: 0	Status/Event Counter 1
Counter 2: 0	Status/Event Counter 2
Counter 3: 0	Status/Event Counter 3
Counter 4: 0	Status/Event Counter 4

### Device Info Display

The device info display provides different service information that may be required for meter identification and inspection, like product and firmware information, communication settings, and so on, and shows device diagnostic messages recorded as a result of the meter self-test diagnostics during start-up and operation.

If there are diagnostic messages, Some of the diagnostics events are cleared automatically as the event source disappears. See [Device Diagnostic Codes](#) in Appendix G for a full list of diagnostic messages and their meanings. See [Clearing Device Diagnostics](#) for information on how to clear the device diagnostics from the display and via PAS.

The diagnostic icon can be disabled or enabled via the [Display Setup](#) menu.

<b>DISPLAY</b>	<b>Description</b>
Diagnostics: 8	Power Down message

<b>DISPLAY</b>	<b>Description</b>
S/N: 12345744 S/W: V12.1.1	Meter identification info, serial number and device SW version
Boot: V1.1.1 Modem: N/A	Boot SW version and Modem setup
COM1: a221,b115.2 Modbus RTU	Communication port COM1 info
COM2: RF, a221 Modbus RTU	Communication port COM2 info
COM3: a1,b19.2 Modbus RTU	Communication port COM3 info

## 3.3 Programming Mode

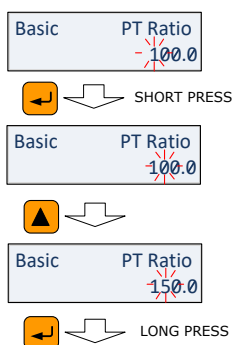
To enter programming mode from the data display, press and hold the SELECT/ENTER button for more than 5 seconds.

### Navigation Buttons

The following table gives a summary of the button operations in programming mode.

Button	Press	Operations
SCROLL	Short press	Scroll through a menu item list in a highlighted window or increment a highlighted digit in a numeric field
SELECT/ENTER	Short press (less than 1 second) = SELECT	Highlight a menu window or a digit in a numeric field
SELECT/ENTER	Long press (1 to 2 seconds) = ENTER	Store the changed item or perform an action indicated in a highlighted window

### Entering Numeric Values

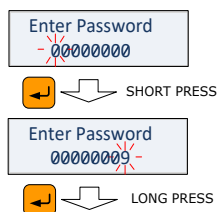


Whenever a numeric value is to be changed, use a short press on the SELECT/ENTER button to highlight a desired digit, and then use the SCROLL button to change the value of the highlighted digit. A highlighted digit appears in inversed color. If you missed a digit, just continue moving through the rest of digits until you reach the desired place.

Once the number is set to the desired value, press and hold the SELECT/ENTER button for 1-2 seconds to save your new setting.

To reject your changes and restore the previous value, use a short press on the SELECT/ENTER button to return to the higher-level window.

### Password Security



The setup menus are secured by 8-digit user passwords. Every time you enter programming mode, you are prompted for a correct password. The meter is primarily shipped with all passwords preset to 9 at the factory.

It is recommended that you change the factory set passwords as fast as possible to protect your setups and accumulated data from unauthorized changes. See [Configuring Meter Passwords](#) in Chapter 5 on how to change passwords in your meter.

Enter the password as you enter numeric values. As you move to the next place, the digit entered is saved and then zeroed. If you missed a digit, you should re-type all preceding digits before you reach the missed place again.

Once the password is set to the desired value, press and hold the SELECT/ENTER button for more than 1 second. If the password you entered is correct, you move to the main device menu, otherwise you return back to the data display.

### Setup Menus and Access Rights

The EM13X Series setup is menu-driven. The meter provides 11 menus that allow local accessing a limited number of meter setups and control

functions listed in the following table. Access to particular menus is granted depending on the security level of the password you entered.

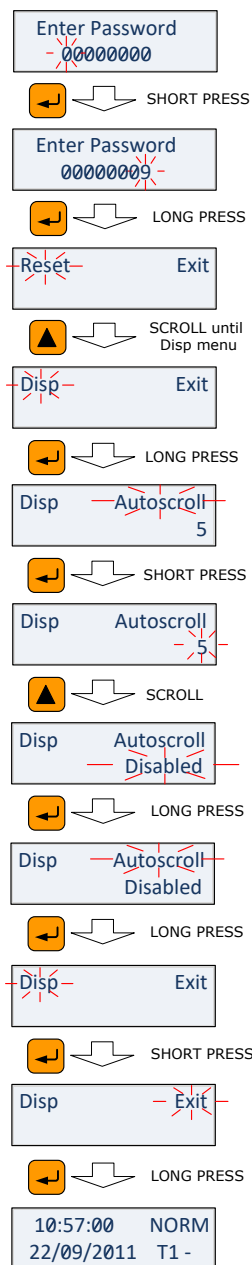
Menu Label	Menu Function	Security Level	
		View	Change
Reset	Reset of billing and engineering maximum demands, device diagnostics, meter and failure counters	Low	See Table below
RTC	RTC clock setup	Low	Low
Basic	Basic device setup	Low	High
Options	Device options setup	Low	High
COM1	COM1 serial port setup	Low	Medium
COM2	COM2 serial port setup	Low	Medium
COM3	COM3 serial port setup	Low	Medium
Local	Local settings	Low	Medium
Disp	Display setup	Low	Low
Access	Meter passwords setup	High	High
Loader	Launches flash download via a local serial port	Medium	Medium

Access to the RESET menu entries is allowed depending on your security level.

If your security level does not allow access to a menu, it will not be listed in the main menu list, and you will not be able to highlight menu items that you are not allowed to change, but you can still view their present settings.



## Viewing and Changing Setup Options



Once you entered a correct password you are moved to the main meter menu.

The main menu has two windows: the left window displays a submenu list, while the right window is an assisting Exit window that allows easy returning back to the data display. A currently active menu item is highlighted by flashing.

To select a desired menu entry from the menu list:

If the left window is not highlighted yet, highlight it by briefly pressing the SELECT/ENTER button.

Use the SCROLL button to scroll through the menu list until the desired menu entry appears

Press the SELECT/ENTER button for more than 1 second to enter the selected submenu.

Once you entered a submenu, the left window is still showing the menu name, while the upper-right window represent a submenu options list, and the lower-right window indicates the present option value.

To select an option you want to view or change:

Use the SCROLL button to scroll through the option list until the desired option's name appears in the window.

To change the selected option's value:

Press the SELECT/ENTER button briefly to highlight the lower-right window.

If an option is represented by a list of values, use the SCROLL button to scroll through the list until a desired value appears in the window. If an option is represented by a numeric value, use the SCROLL button to adjust each digit to the desired value, and use a short press on the SELECT/ENTER button to move through digits.

Once the desired value is selected, press the SELECT/ENTER button for more than 1 second to save your new setting. You return to the upper-right window and can continue scrolling through the rest of options or can return to the main menu

If you wish to leave the option value unchanged, use a short press on the SELECT/ENTER button to return to the upper-right window.

To exit the submenu and return to the main menu:

- If the upper-right window is not highlighted yet, highlight it by briefly pressing the SELECT/ENTER button.
- Press the SELECT/ENTER button for more than 1 second. You will return to the main menu.

To exit the main menu and return to the data display:

- Press briefly the SELECT/ENTER button to highlight the right-upper Exit window.
- Press the SELECT/ENTER button for more than 1 second. You will return back to the data display.

# Chapter 4 Using PAS Software

The support PAS software is a configuration and data acquisition tool that allows you to configure all of the EM13X Series features, monitor your meters on-line, retrieve recorded files and view reports. PAS can communicate with your EM13X Series via a serial port and via the Ethernet.

This chapter gives information on how to install and run PAS on your computer, and how to prepare information for your meter using PAS.

## 4.1 Installing PAS

You need PAS V1.4 Build 5 or higher to take an advantage of the meter data logging options.

To install PAS on your PC:



Insert the installation CD supplied with your meter into CD drive.

Open **My Computer** on your Desktop.

Click on your CD drive icon, select the PAS directory, and then double click on Setup (shown as an Application type file).

Follow InstallShield® Wizard instructions on the screen.

PAS is installed by default to the C:\Pas folder.

When installation is complete, the PAS icon appears on your Desktop. Double click on the PAS icon to run PAS.

For general information on how to work with PAS, see the "PAS Getting Started" guide supplied on the installation CD.

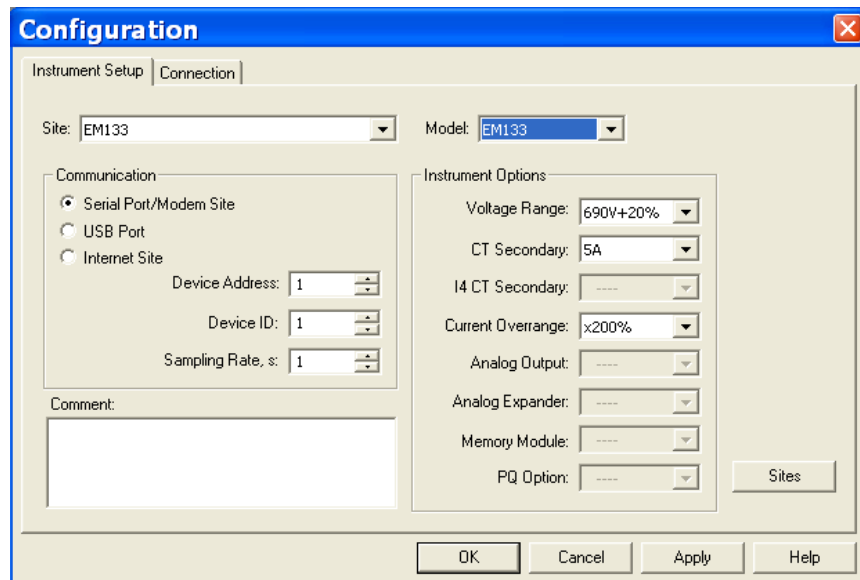
## 4.2 Creating a New Site for your Meter

PAS keeps all communication and configuration data for your meter in a configuration database called a site database. During configuration, store all setup data to the site database so that PAS recognizes device properties regardless of whether the meter is online or offline.

To communicate with the meters, create a separate site database for each device.

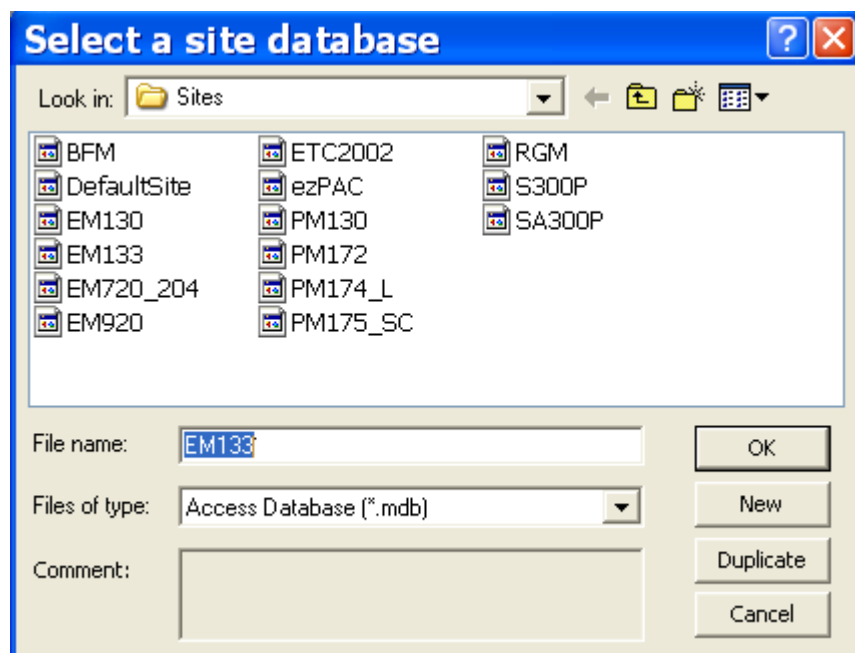
To create a new database for your meter:

Select **Configuration** from the **Tools** menu.



**Figure 4-1: Configuration Dialog Box – Instrument Setup Tab**

Click the **Sites** button on the right-hand-side.



From the **Look in** box, select the directory where a new database will be stored. By default, it is the **Sites** directory.

Type a site name for your device in the **File name** box, click **New**, and then click **OK**.

On the **Instrument Setup** tab, select **EM13X Series** in the **Model** box. PAS automatically selects the appropriate instrument options for your meter.

Select a correct CT secondary current (5A or 1A) for your meter.

If you wish to add any comments for your meter, type the comments in the **Comment** box.

For more device configuration details using PASTM Software refer to PM130 PLUS Installation and Operation Manual BG0425 REV.12

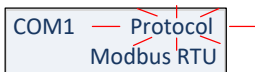
# Chapter 5 Configuring the EM13X Series

This chapter describes how to configure the EM13X Series for your particular environment and application from the front display and via PAS. To access your meter configuration options via PAS, you should create a site database for your device as shown in Chapter 4.

## 5.1 Configuring Communications

### Setting Up Serial Communication Ports

#### Using the Front Display



Select COM1 through COM3 from the main menu. See [Viewing and Changing Setup Options](#) in Chapter 3 for information on navigating in menus.

See the table below for available communication options.

#### Using PAS

Select Communications Setup from the Meter Setup menu, and then click on the Serial Ports Setup tab. In the Port box, select the desired device port.

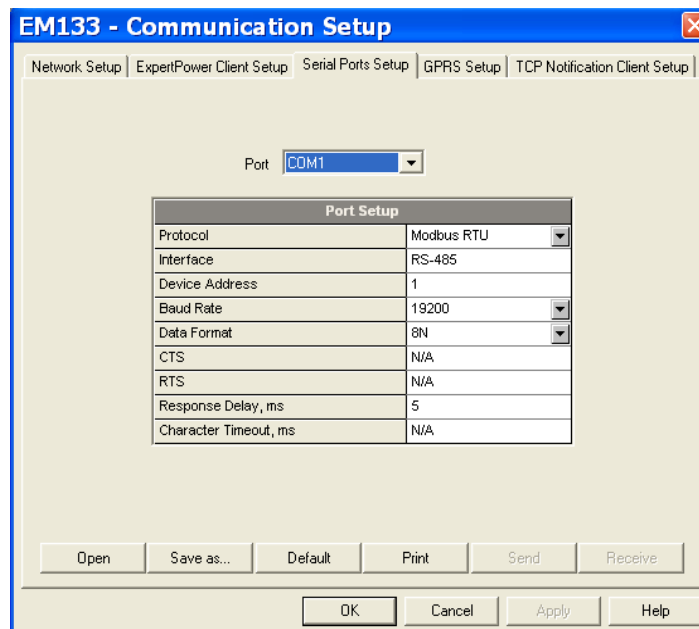


Figure 5-1: Communication Setup Dialog Box – Serial Ports Setup Tab

To change the port settings in your device, select desired port parameters, and then click Send.

The following table lists available port options.

**Table 4: COM Port Options**

Display Label	Parameter	Options	Default	Description
Protocol	Communication protocol	MODBUS RTU, MODBUS ASCII, DNP3, SATEC ASCII, IEC 60870-5	MODBUS RTU (COM 1-3)	The communications protocol for the port
Interface	Port interface	RS485, RS232, IR, GPRS <sup>1</sup> , ETHERNET, PROFIBUS, CANopen	RS485 (COM1) RS232 (COM2) IR (COM3)	Not changeable; automatically detected by the meter
Address	Device address	MODBUS: 1-247 DNP3: 0-65532 IEC 60870-5: 1-4095	1	Device network address
Baud Rate	Baud rate	COM1: 300-115.2 kbps, COM2: 300-115.2 kbps COM3: 9600-38400 kbps	19.2 kbps	The port baud rate
Data/Parity	Data format and parity	7E, 8N, 8E	8N	7E data format should not be used with the MODBUS RTU and DNP3 protocols
Send Delay	Response delay	0-1000 ms	5 ms	The minimum time after the last request character is received to start the transmission.
Chr.Timeout	Character timeout	0-1000 ms	4 ms	The maximum time the line is allowed to idle before closing a connection in the MODBUS RTU and DNP3 protocols

The meter automatically detects replaceable communication modules and does not allow you to change the baud rate and data format for the Dial-up GSM/GPRS<sup>3</sup> modem.

<sup>1</sup> GPRS – also covers 3G & 4G network

## Setting up the Ethernet

### Using the Front Display

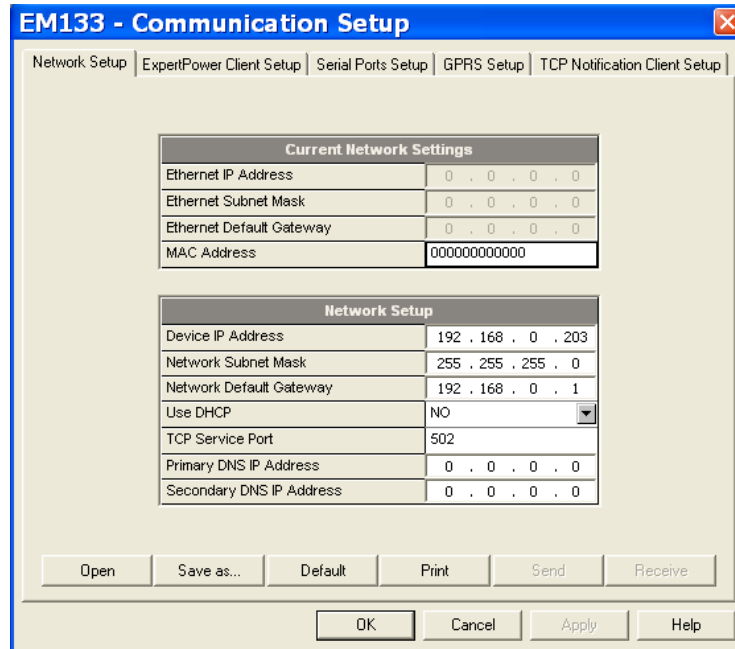


Select Net from the main menu. See [Viewing and Changing Setup Options](#) in Chapter 3 for information on navigating in menus.

See the table below for available network options.

### Using PAS

Select Communications Setup from the Meter Setup menu, and then click on the Network Setup tab.




**Figure 5-2: Communication Setup Dialog Box – Network Setup Tab**

The following table lists available network options.

**Table 5: Ethernet Setup Options**

Display Label	Parameter	Default
IP Address	Device IP Address	192.168.0.203
Subnet Mask	Network Subnet Mask	255.255.255.0
Def. Gateway	Network Default Gateway	192.168.0.1
TCPServicePort	502 = Modbus/TCP 20000 = DNP3/TCP	502

#### NOTES

- The meter provides the permanent MODBUS TCP server on port 502.
  - Selecting the DNP3 TCP service port launches the second DNP3 TCP server allowing simultaneous connections on both TCP ports. Selecting the Modbus TCP port disables the DNP3 TCP server.
-  The TCP service port can also be changed through the COM2 serial port setup. Changing the communication protocol for the port automatically changes the TCP port for the Ethernet.
- When you change the device network settings through the Ethernet port, the device port restarts so communication will be temporarily lost. You may need to wait some additional time until PAS restores a connection with your device. Setting-Up Dial-Up GPRS Network

## Setting up GPRS Network

### Using the Front Display

The EM13X Series can provide wireless Cellular communications with the remote Modbus/TCP server via an external Enfora GSM1308 SA-G+ GSM/GPRS modem. See [Connecting a GSM/GPRS modem](#) in Chapter 2 on how to connect a modem to your meter.

### Using PAS

- Select Communications Setup from the Meter Setup menu, and then click on the GPRS Setup tab.

Select **Communications Setup** from the **Meter Setup** menu, and then click on the **GPRS Setup** tab.

The screenshot shows a software window titled "EM133 - Communication Setup" with a close button (X) in the top right corner. The window has a tabbed interface with the following tabs: "Network Setup", "GPRS Setup" (selected), "ExpertPower Client Setup", "TCP Notification Client Setup", and "Serial Ports Setup". The main content area contains two tables:

Network Settings	
Local IP Address	0 . 0 . 0 . 0

GPRS Setup	
Access Point Name (APN)	internet
User name	
Password	
GPRS Mode	Server mode

At the bottom of the dialog box, there are two rows of buttons. The first row contains "Open", "Save as...", "Default", "Print", "Send", and "Receive". The second row contains "OK", "Cancel", "Apply", and "Help".

**Figure 5-3: Communication Setup Dialog Box – GPRS Setup Tab**

The following table lists available GPRS options.

**Table 6: GPRS Setup Options**

Parameter	Default	Description
Access Point Name (APN)	internetg	The mobile network APN name
User name		Username (if required)
Password		Password (if required)
GPRS Mode	Client mode	Can also be configured as server

- Configure your mobile network APN, username and password. Consult your network operator regarding proper network settings. Leave the username and password fields blank if network authorization is not required.
- Send your GPRS settings to the meter.
- Select the GPRS interface in the COM2 port setup (see [Setting Up Serial Communication Ports](#)).
- Configure your eXpertPower client (see [Setting Up eXpertPower Client](#)) or/and TCP Notification client (see [Setting Up TCP Notification Client](#)) for communicating with a remote server.

You can check the status of the GPRS communications from the front panel via the [Status Display](#) or via the Device Control dialog in PAS (see [Viewing Communication Status and Statistics](#)).

## Setting Up WiFi Network

WiFi communications is available in the meters equipped with a WiFi expansion module.

	Make sure the power is off before attaching a WiFi expansion module to the meter to avoid damage to sensitive electronic components.
--	--

A WiFi module can be configured to work in one of the following modes:

- a) as a regular WiFi station for connection of the meter to an existing WiFi network;
- b) as a WiFi access point/router to create a separate secured WiFi network without using an additional external router. It also serves as a network gateway for the connected meter.

When access point mode is disabled (see instructions below), the module operates as a regular WiFi station.

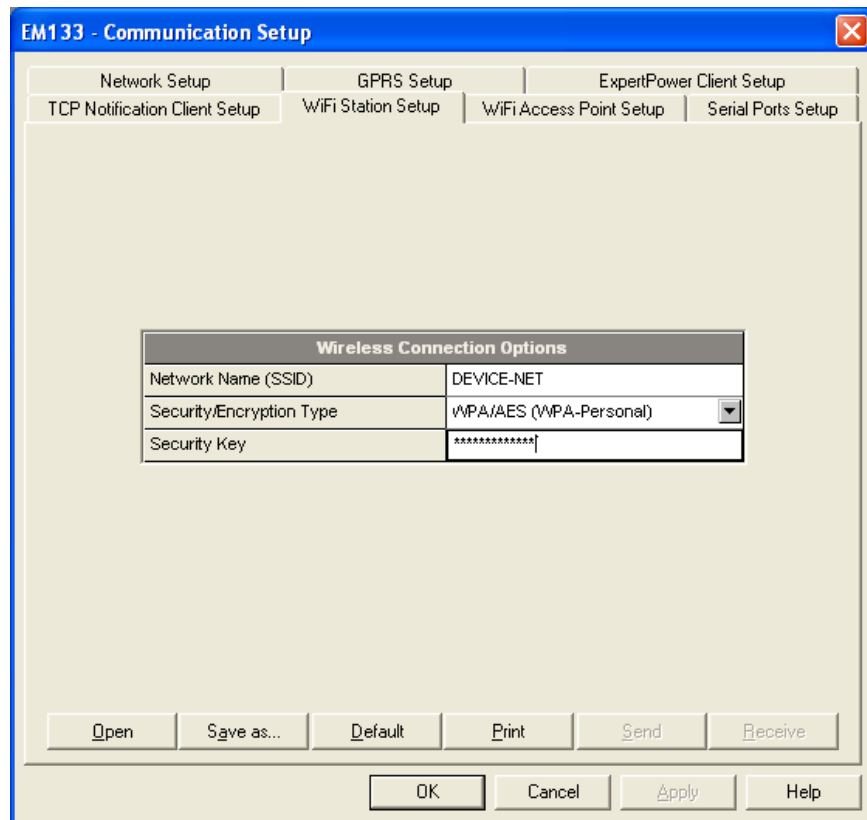
Use the accompanying PAS software to configure WiFi communications in your meters.

### Configuring WiFi Station Parameters

Skip this section if the WiFi module is to be configured as an access point/router since the network parameters for the meter will be automatically set up.

To connect your meter to the existing wireless network, select Communication Setup from the Meter Setup menu and click on the WiFi Station Setup tab.





Configure the wireless network parameters as follows:

**Network Name (SSID)** – the wireless network name you want to connect to. The default factory preset network name is DEVICE-NET.

**Security/Encryption Type** – the WiFi security and data encryption method set for the wireless network in the network router.

**Security Key** – the pass phrase to authenticate the meter with your wireless network.

If you connect the meter to a SATEC WiFi network, use same network authentication parameters as you configured for the network access point/router (see Section 3 below).

If you connect the meter to a foreign WiFi network, you can identify the wireless network parameters via the Windows Network and Sharing Center on your PC connected to the WiFi network:

On Windows 7 and 8.1, click the Start button, and then open the Control Panel. Select Network and Internet -> Network and Sharing Center.

On Windows 10, click the Start button, then select Settings -> Network & Internet -> Status -> Network and Sharing Center.

In Network and Sharing Center, next to **Connections**, select your WiFi network name. In Wi-Fi Status, select **Wireless Properties**, and then **click on the Security** tab to see the network security type and encryption method. Check the **Show characters** check box to see your WiFi network security key.

## Configuring WiFi Access Point/Router Mode

To configure a WiFi module as a WiFi access point, select Communication Setup from the Meter Setup menu and click on the WiFi Access Point Setup tab.

The following explains the network parameters you need to configure for your wireless network:

Access Point Enable – defines the WiFi module operation mode: Disabled = WiFi station mode, Enabled = WiFi Access Point/Router mode.

Network Name (SSID) – the wireless network name (service set identifier) that uniquely identifies your wireless network among other neighboring networks – 1 to 15 ASCII characters long. The default network name is DEVICE-NET.

WiFi Protocol – the WiFi physical layer protocol that defines the supported WiFi network technology and network bandwidth. If you find it difficult to choose the right one to cover all technologies supported by your network devices, it's recommended that you leave the default 802.11b/g/n protocol setting.

WiFi Channel – selects the working network channel (frequency band) among 11 available channels. You can select a fixed channel or set it to AUTO mode (factory default) so that the module will automatically select the most reliable channel for your network.

LAN IP Address – the network router IP address. It also defines the range of addresses (address segment, or network prefix) to be used across your wireless network. It is recommended to use private (non-routable) address segments you can select from the following ranges:

10.0.0.1 – 10.255.255.254

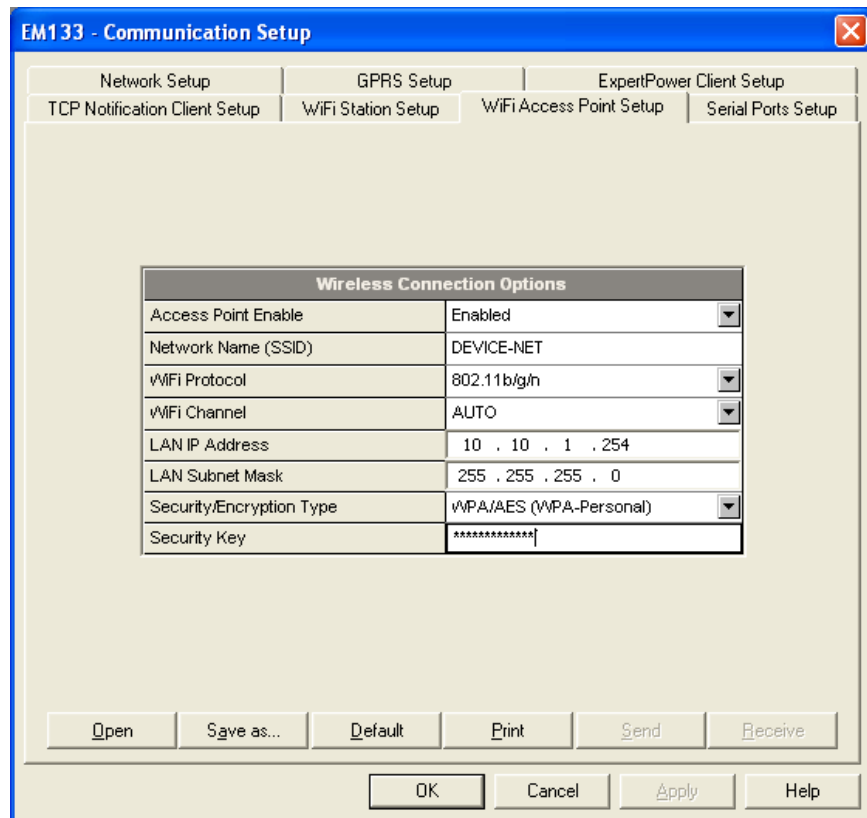
172.16.0.1 – 172.31.255.254

192.168.0.1 – 192.168.255.254

The default factory set wireless LAN router address is 10.10.1.254.

LAN Subnet Mask – specifies the network prefix part of the IP addresses (address segment) for your wireless network. The default 255.255.255.0 mask defines the network prefix as 10.10.1.XXX, where XXX – the host part of 1 to 254 you can assign to wireless devices connected to the network.

Security/Encryption Type – the WiFi security and data encryption method for your wireless network. The default WPA/AES setting is chosen meaning the support of most available wireless devices. For higher security, select WPA2/AES as the most secure option that is now the current standard for WiFi security.



Security Key – the pass phrase (password) that will be used to authenticate connected devices with your wireless network. Depending on the selected security type, the security key length should be as follows:

WEP – 5 or 13 ASCII characters (64-bit or 128-bit key respectively)

WPA and WPA2 – 8 to 15 ASCII characters.

The factory-set temporary security key is “12345678”. For highest security, use WPA2/AES encryption with a randomly selected security key.

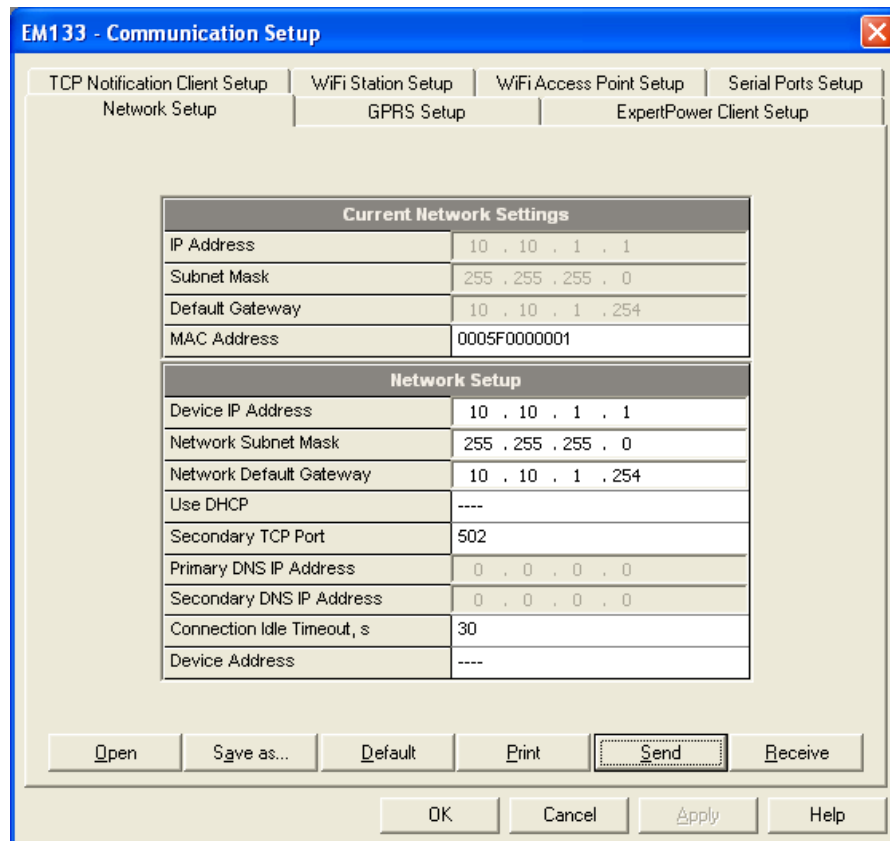
### **Configuring Network IP Addresses**

SATEC meters use fixed network addresses rather than dynamic address configuration to avoid receiving a random address every time the meter is reconnected to a WiFi network.

**NOTE: The meter connected to a WiFi access point/router should be provided with a network address different from the LAN/router IP address like any other WiFi device.**

You can configure the network address in your meter either from the meter front display (see the meter operation manual for more information), or via PAS.

To configure the meter address via PAS, select Communication Setup from the Meter Setup menu and click on the Network Setup tab.



Configure the meter's wireless network address as follows.

If your meter is connected to a SATEC WiFi network, set the default gateway and the network subnet mask to the LAN IP address and LAN subnet mask as you configured for the WiFi network access points in Section 3. For the device IP address, use the WiFi network prefix (address segment) with a host part in the range of 1-99 or 200-254. Host addresses 100 to 199 are reserved for dynamic configuration of the devices and computers connected to the network using DHCP protocol.

If you connect the meter to a foreign WiFi network, you can identify the default gateway address and subnet mask via the Windows Network and Sharing Center on your PC connected to the WiFi network as shown above in Section 2. In Network and Sharing Center, next to **Connections**, select your Wi-Fi network name. In Wi-Fi Status, select **Details**. **Consult with the network administrator for the applicable host IP addresses, or select one within the network address segment that has not** yet been assigned to any host across the WiFi network.

## Monitoring a WiFi Connection

If your WiFi module is properly configured, the meter will automatically connect to the WiFi network any time the meter is restarted.

You can monitor the connection status and signal quality via the meter front display or via PAS.

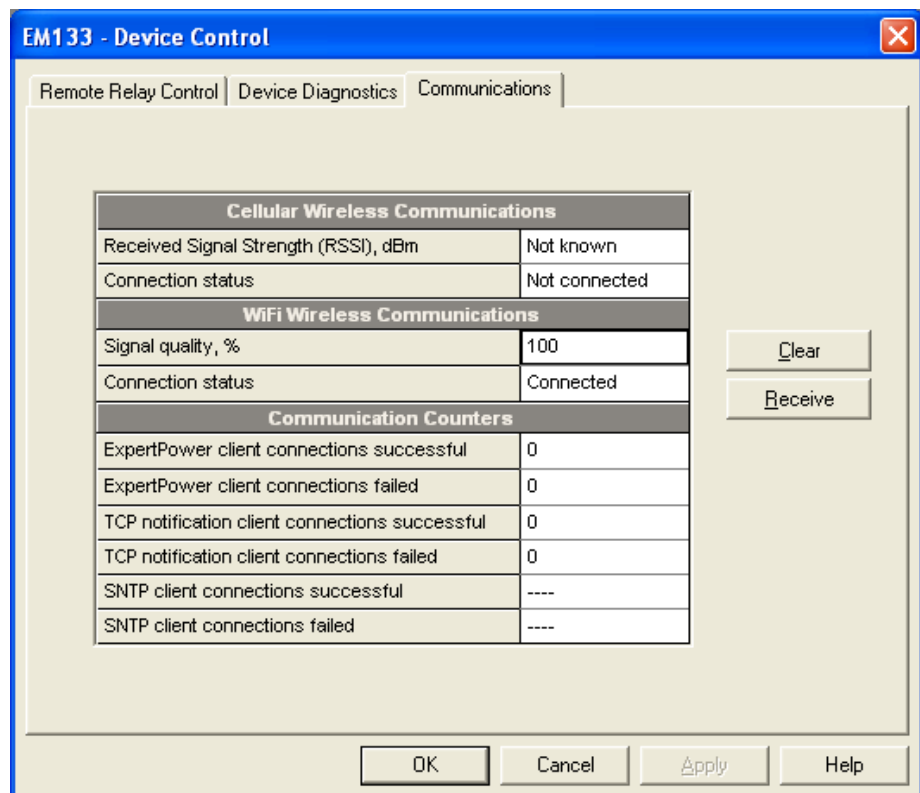
To check a WiFi connection from the meter display:

In the EM133, move to the Diagnostics display and then scroll to the "WiFi" page where you can see the network connection status and received signal quality. The following page indicates the meter network address.

In the PM130, move to the STA display and then scroll to the "rSSI" page where you can see the received signal quality in percent followed by the network connection status.

In the PM135, move to the Device Info display and then scroll to the "WiFi" page.

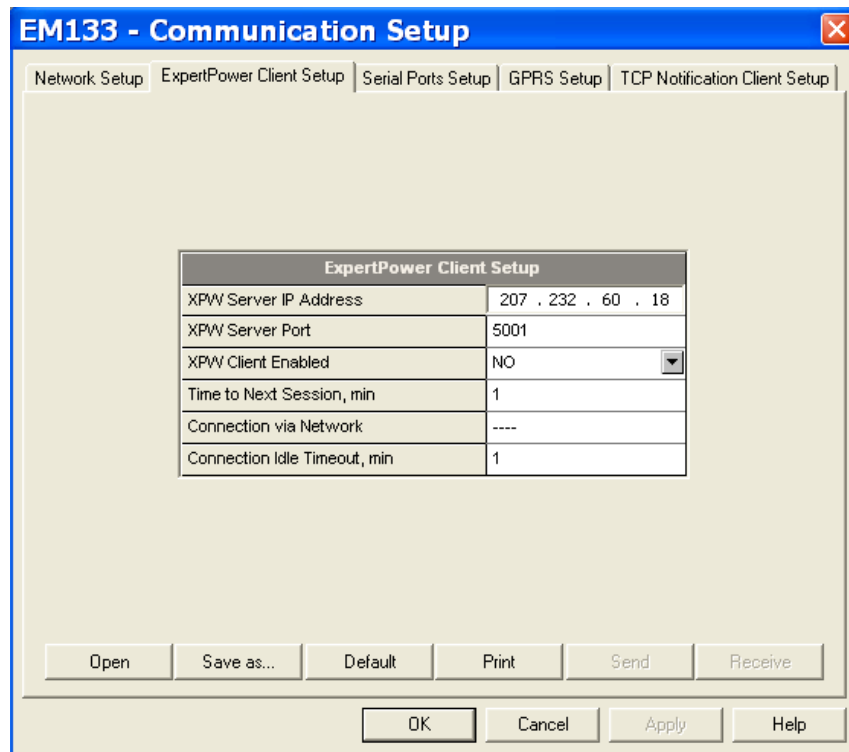
To check a WiFi connection via PAS, select Device Control from the Monitor menu and click on the Communications tab. The connection status and received signal quality are indicated under the WiFi Wireless Communications section.



## Setting Up eXpertPower Client

The PM130 PLUS has an embedded eXpertPower™ client that provides communications with the eXpertPower™ server – the SATEC proprietary Internet services. Connections to the eXpertPower™ server are handled on a periodic basis.

To set up communications with the eXpertPower™ server, select **Communication Setup** from the **Meter Setup** menu, and then click on the **ExpertPower Client Setup** tab.



**Figure 5-4: eXpertPower Client Setup Tab**

The following table lists available options. Refer to your eXpertPower service provider for the correct network settings.

**Table 6: eXpertPower Client Setup Options**

Parameter	Options	Default	Description
XPW Server IP Address		207.232.60.18	The IP address of the eXpertPower server
XPWServerPort	0-65535	5001	The TCP service port of the eXpertPower server
XPW Client Enabled	NO, YES	NO	Enables operations of the eXpertPower client
Time to Next Session, min	1-99999		The time remaining to the next connection session

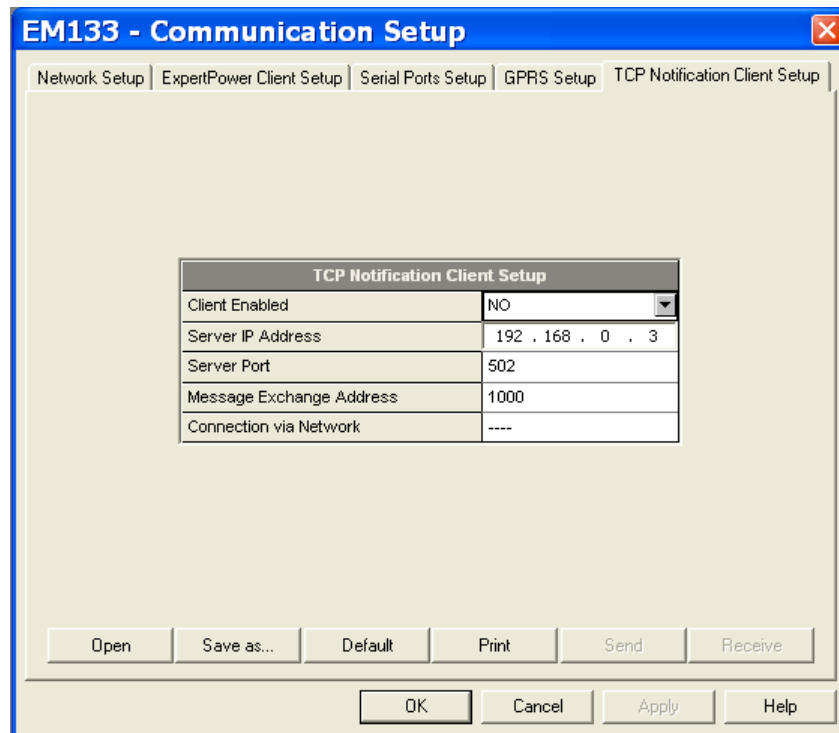
**NOTES**

- Do not enable the eXpertPower client in your meter if you do not use the eXpertPower™ service.
- Do not change the connection time setting. It is for information only. The eXpertPower server updates it automatically.

### Setting Up TCP Notification Client

The TCP notification client can establish connections with a remote Modbus/TCP server and send notification messages either on events, or periodically on a time basis.

To set up communications with a remote TCP Notification server, select **Communication Setup** from the **Meter Setup** menu, and then click on the **TCP Notification Client Setup** tab.

**Figure 5-5: TCP Notification Client Setup Tab**

The following table lists available client options.

**Table 7: TCP Notification Client Setup Options**

Parameter	Options	Default	Description
Client Enabled	NO, YES	NO	Enables operations of the notification client
Server IP Address		192.168.0.3	The IP address of the notification server
ServerPort	0-65535	502	The TCP service port of the notification server
Message Exchange Address	0-65535	1000	The start address of a block of 16 Modbus registers for receiving notification messages

Connections with a remote server are triggered via programmable setpoints. To send event notifications to a server, configure a setpoint to respond to desired triggers or to periodic time events and put the "Notification" action to the setpoint action list (see [Configuring Alarm/Control Setpoints](#)).

See the PM130 PLUS Modbus Reference guide for more information on operation of the notification client and the notification message structure.

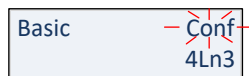
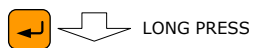
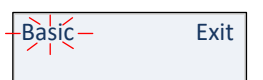
## 5.2 General Meter Setup

### Basic Meter Setup

This section describes how to configure the EM13X Series for your particular environment and application.

Before operating your meter, provide the device with basic information about your electrical network.

## Using the Front Display



Select the **Basic** entry from the main menu. See [Viewing and Changing Setup Options](#) in Chapter 3 for information on configuring parameters via the front display.

See the table below for the Basic Setup options.



**Using PAS**

Select **General Setup** from the **Meter Setup** menu. See the table below for the Basic Setup options.

**Table 8: Basic Setup Options**

Display Label	Parameter	Options	Default	Description
Conf	Wiring Mode	See <a href="#">Table 9</a>	4Ln3	The wiring connection of the device
PT Ratio	PT Ratio	1.0-6500.0	1.0	The phase potential transformer's primary to secondary ratio
PT Factor	PT Ratio Multiplier	×1, ×10	×1	PT Ratio multiplication factor. Used in extra high voltage networks to accommodate the PT ratio for 500 kV and higher networks.
CT	CT Primary Current	1-50000 A	5 A	The primary rating of the phase current transformer
PowDmdPer	Power block demand period	1, 2, 3, 5, 10, 15, 20, 30, 60 min, E=external sync	15 min	The length of the demand period for power demand calculations. If the external synchronization is selected, a pulse front on the digital input DI1 denotes the start of the demand interval.
Num.Per.	The number of blocks in the sliding demand window	1-15	1	The number of blocks to be averaged for sliding window demands
ADmdPer.	Volt/Ampere Demand Period	0-1800 sec	900 sec	The length of the demand period for ampere and volt demand calculations
Freq	Nominal Frequency	50,60,25,400 Hz	60 Hz	The nominal line frequency
MaxDmdLd	Maximum Demand Load Current	0-50000 A	0	The maximum demand load current (0 = CT primary current)



1. Always specify the wiring mode and transformer ratings prior to setting up setpoints and analog outputs.
2. The maximum value for the product of the phase CT primary current and PT ratio is 57,500,000. If the product is greater, power readings are zeroed.

The screenshot shows the 'EM133 - General Setup' dialog box with the 'Basic Setup' tab selected. The dialog is divided into several sections: 'Pulse/Event Counters', 'Device Options', 'Local Settings', and 'Display Setup'. Under 'Local Settings', the 'Basic Setup' sub-tab is active. The 'Basic Configuration' section includes fields for Wiring Mode (4LN3), PT Ratio (1.0), PT Ratio Multiplier (x1), PT4 Ratio (----), CT Primary Current, A (5), I4 CT Primary Current, A (----), Nominal Secondary L-N/L-L Voltage, Un, V (----), Maximum Demand Load Current, A (CT), Nominal Frequency, Hz (50), and Phase Order (----). The 'Demand Setup' section includes Power Block Demand Period, min (15), Number of Blocks in Sliding Demand (1), Power Thermal Time Constant, s (----), and Volt/Ampere Demand Period, s (900). At the bottom, there are buttons for 'Open', 'Save as...', 'Default', 'Print', 'Send', 'Receive', 'OK', 'Cancel', 'Apply', and 'Help'.

**Figure 5-6: General Setup Dialog Box – Basic Setup Tab**

Table 9 lists the available wiring modes.

**Table 9: Wiring Modes**

Wiring Mode	Description
3OP2	3-wire Open Delta using 2 CTs (2 element)
4LN3	4-wire Wye using 3 PTs (3 element), line-to-neutral voltage readings
3DIR2	3-wire Delta Direct Connection using 2 CTs (2 element)
4LL3	4-wire Wye using 3 PTs (3 element), line-to-line voltage readings
3OP3	3-wire Open Delta using 3 CTs (2½ element)
3LN3	4-wire Wye using 2 PTs (2½ element), line-to-neutral voltage readings
3LL3	4-wire Wye using 2 PTs (2½ element), line-to-line voltage readings
3BLN3	3-wire Broken Delta using 2 PTs, 3 CTs (2½ element), line-to-neutral voltage readings
3BLL3	3-wire Broken Delta using 2 PTs, 3 CTs (2½ element), line-to-line voltage readings

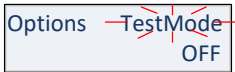


In 4LN3, 3LN3 and 3BLN3 wiring modes, Min/Max volts, volt demands and voltage harmonics represent line-to-neutral voltages; otherwise, they will be line-to-line voltages.

## Device Options

The Device Options setup allows changing user-configurable device options or putting the meter into energy test mode.

### Using the Front Display



Select **Options** from the main menu. See [Viewing and Changing Setup Options](#) in Chapter 3 for information on configuring parameters via the front display.

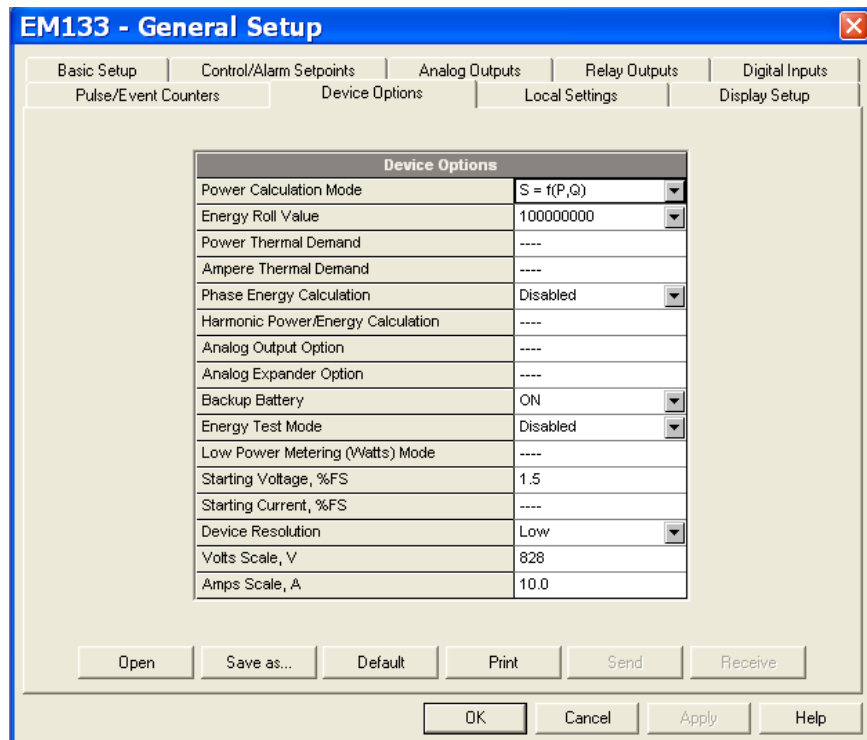
### Using PAS

Select **General Setup** from the **Meter Setup** menu, and then click on the **Device Options** tab.

Table 10 lists available device options.

**Table 10: User-configurable Device Options**

Display Label	Parameter	Options	Default	Description
TestMode	Energy Test Mode	Three options: OFF = disabled Wh pulses varh pulses	Disabled	Setting this option puts the meter into the energy test mode (see <a href="#">Energy Pulse LED</a> in Chapter 3)
PowMode	Power Calculation Mode	Reactive = using reactive power $S=f(P, Q)$ , NonActive = using non-active power $Q=f(S, P)$	$S=f(P, Q)$	The method used for calculating reactive and apparent powers (see <a href="#">Power Calculation Modes</a> below)
EngyRoll	Energy Roll Value	10000 = 10000 kWh 100000 = 100000 kWh 1000000 = 1000000 kWh 10000000 = 10000000 kWh 100000000 = 100000000 kWh 1000000000 = 1000000000 kWh	10000000	The value at which energy counters roll over to zero
Phs.Engy	Phase Energy Calculation	Disabled Enabled	Disabled	Enables phase energy calculations
StrtVolt	Starting Voltage	1.5-5.0%	1.5%	The device starting voltage in percent of FS (120V or 400V)
Resolution	Device Resolution	Low High	Low	The voltage, current and power resolution on the front display (see <a href="#">Measurement Units</a> in Chapter 3) and in communications (see communication guides)



**Figure 5-7: General Setup Dialog Box – Device Options Tab**

### Power Calculation Modes

The power calculation mode option allows you to change the method for calculating reactive and apparent powers in presence of high harmonics. The options work as follows:

- When the reactive power calculation mode is selected, active and reactive powers are measured directly and apparent power is calculated as:

$$S = \sqrt{P^2 + Q^2}$$

- This mode is recommended for electrical networks with low harmonic distortion, commonly with THD < 5% for volts, and THD < 10% for currents. In networks with high harmonics, the second method is preferable.

- When the non-active power calculation mode is selected, active power is measured directly, apparent power is taken as product  $S = V \times I$ , where V and I are the RMS volts and amps, and reactive power (called non-active power) is calculated as:

$$N = \sqrt{S^2 - P^2}$$

### Configuring Digital Inputs

The EM13X Series can be provided with two digital inputs (standard) and 4, 8 or 12 optional digital inputs that can be linked to control setpoints to give an indication on input status change (see [Configuring Alarm/Control Setpoints](#)), or can be linked to general pulse counters to count incoming pulses (see [Configuring Counters](#)). They can also be linked to the Billing/TOU registers to count pulses from external wattmeters or gas and water meters.

**Using PAS**

Select **General Setup** from the **Meter Setup** menu, and then click on the **Digital Inputs** tab.

Digital Inputs				
No.	Input Polarity	Pulse Input Mode	Pulse Polarity	Debounce Time, ms
1	NORMAL	PULSE MODE	NORMAL (N.O.)	10
2	NORMAL	PULSE MODE	NORMAL (N.O.)	10
3	INVERTING	PULSE MODE	NORMAL (N.O.)	10
4	NORMAL	PULSE MODE	NORMAL (N.O.)	10
5	NORMAL	PULSE MODE	NORMAL (N.O.)	10
6	NORMAL	PULSE MODE	NORMAL (N.O.)	10
7	NORMAL	PULSE MODE	NORMAL (N.O.)	10
8	NORMAL	PULSE MODE	NORMAL (N.O.)	10
9	NORMAL	PULSE MODE	NORMAL (N.O.)	10
10	NORMAL	PULSE MODE	NORMAL (N.O.)	10
11	NORMAL	PULSE MODE	NORMAL (N.O.)	10
12	NORMAL	PULSE MODE	NORMAL (N.O.)	10
13	NORMAL	PULSE MODE	NORMAL (N.O.)	10
14	NORMAL	PULSE MODE	NORMAL (N.O.)	10
15	----	----	----	----
16	----	----	----	----

**Figure 5-8: General Setup Dialog Box – Digital Inputs Dialog Box**

The available options are shown in Table 11.

**Table 11: Digital Inputs Options**

Parameter	Options	Default	Description
Input Polarity	NORMAL INVERTING	NORMAL	For the normal polarity, the open to closed transition is considered closed. For the inverting polarity, the closed to open transition is considered a closed
Pulse Input Mode	PULSE MODE KYZ MODE	PULSE MODE	In pulse mode, either leading, or trailing edge of the input pulse is recognized as an event. In KYZ mode, both leading and trailing edges of the input pulse are recognized as separate events.
Pulse Polarity	NORMAL (N.O.), INVERTING (N.C.)	NORMAL	For the normal polarity, the open to closed transition is considered a pulse. For the inverting polarity, the closed to open transition is considered a pulse. It has no meaning in KYZ mode where both transitions are used.
Debounce Time	1-100 ms	10 ms	The amount of time while the state of the digital input should not change to be recognized as a new state. Too low debounce time could produce multiple events on the input change.

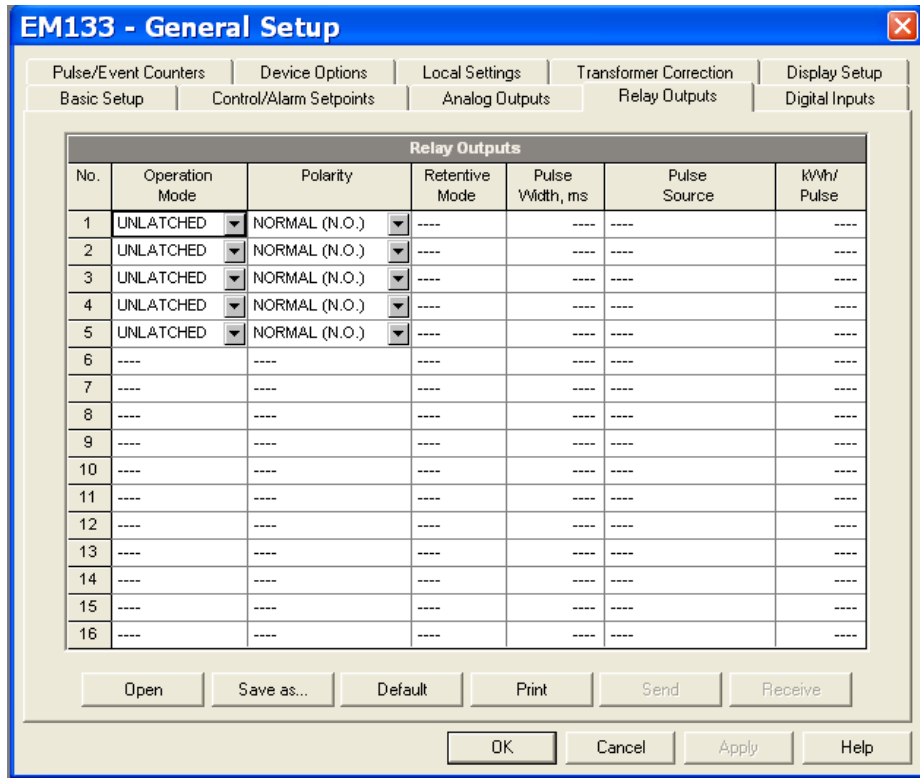
The debounce time is applied the same for all digital inputs. If you change the debounce time for a digital input, the same debounce time is automatically assigned to the others.

## Configuring Relay Outputs

The PM130 PLUS can be provided with one relay (standard) and 2 or 4 optional relay outputs. Each relay can be operated either locally from the alarm/control setpoints in response to an event or by a remote command sent through communications. It can also be linked to an internal pulse source to produce energy pulses.

## Using PAS

Select **General Setup** from the **Meter Setup** menu, and then click on the **Relay Outputs** tab.



**Figure 5-9: General Setup Dialog Box – Relay Outputs Tab**

The available relay outputs options are shown in Table 12.

**Table 12: Relay Output Options**

Parameter	Options	Default	Description
Operation mode	UNLATCHED LATCHED PULSE KYZ	UNLATCHED	Unlatched mode: the relay goes into its active state when the control setpoint is in active (operated) state, and returns into its non-active state when the setpoint is released. Latched mode: the relay goes into its active state when the control setpoint goes into active state and remains in the active state until it is returned into its non-active state by a remote command. Pulse mode (normal pulse): the relay goes into its active state for the specified time, goes into non-active state for the specified time and remains in the non-active state. KYZ mode (transition pulse): the relay generates transition pulses. The relay changes its output state upon each command and remains in this state until the next command.
Polarity	NORMAL (N.O.) INVERTING (N.C.)	NORMAL	Normal polarity: the relay is normally de-energized in its non-active state and is energized in its active (operated) state. Inverting polarity: the relay is normally energized in its non-active state and is de-energized in its active (operated) state. It is called failsafe relay operation.
Pulse width	20-1000 ms	100 ms	The actual pulse width is a multiple of the 1-cycle time rounded to the nearest bigger value. The pause time between pulses is equal to the pulse width.
Pulse source	NONE Ac.Ei = kWh IMP Ac.EE = kWh EXP rE.Ei = kvarh IMP rE.EE = kvarh EXP rE.Et = kvarh TOT AP.Et = kVAh TOT	NONE	Links a pulse relay to the internal energy pulse source. The relay must be set into either pulse, or KYZ mode.
Pulse rate, kWh/Pulse	0.1-1000.0	1.0 kWh/Pulse	Defines the pulse weight in kWh units per pulse



### Generating Energy Pulses through Relay Outputs

To generate energy pulses through a relay output:

- Set a relay to either pulse, or KYZ mode, and then select a polarity (active pulse edge) for energy pulses and a pulse width.
- Select a source energy accumulator and the pulse rate for your output
- Send your new setup to the meter

### Configuring Analog Outputs

The meter can be ordered with four optional analog outputs with options for 0-1mA,  $\pm 1$ mA, 0-20mA and 4-20mA current outputs.

### Using PAS

Select **General Setup** from the **Meter Setup** menu, and then click on the **Analog Outputs** tab.

Analog Outputs				
No.	AO Type	Output parameter	Zero Scale (0/4 mA)	Full Scale (1/20 mA)
1	+/-1 mA	V1/12 RT	0	1440
2	+/-1 mA	V2/23 RT	0	1440
3	+/-1 mA	V3/31 RT	0	1440
4	+/-1 mA	FREQ AVR	0.00	65
5	----	----	----	----
6	----	----	----	----
7	----	----	----	----
8	----	----	----	----
9	----	----	----	----
10	----	----	----	----
11	----	----	----	----
12	----	----	----	----
13	----	----	----	----
14	----	----	----	----
15	----	----	----	----
16	----	----	----	----

**Figure 5-10: General Setup Dialog Box – Analog Outputs Tab**

The available analog output options are described in Table 13.

**Table 13: Analog Output Options**

Option	Range	Description
AO type	0-1mA ±1mA 0-20mA 4-20mA	The analog output type. When connected to the meter, shows the actual AO type received from the device. When working off-line, select the analog output option corresponding to your analog module.
Output parameter	See Appendix B	Selects the measured parameter to be transmitted through the analog output channel.
Zero scale		Defines the low engineering scale (in primary units) for the analog output corresponding to a lowest (zero) output current (0 or 4 mA)
Full scale		Defines the high engineering scale (in primary units) for the analog output corresponding to a highest output current (1 or 20 mA)

When you select an output parameter for the analog output channel, the default engineering scales are set automatically. They correspond to the maximum available scales. If the parameter actually covers a lower range, you can change the scales to provide a better resolution on an analog output.

### Scaling Non-Directional Analog Outputs

For non-directional analog outputs with a 0-1mA, 0-20mA or 4-20mA current option, you can change both zero and full engineering scales for any parameter. The engineering scale need not be symmetrical.

### Scaling Directional Power Factor

The engineering scale for the signed power factor emulates analog power factor meters.

The power factor scale is -0 to +0 and is symmetrical with regard to ±1.000 (-1.000 = +1.000). The negative power factor is scaled as -1.000 minus the measured value, and non-negative power factor is scaled as +1.000 minus the measured value. To define the entire power factor range from -0 to +0, the default scales are specified as -0.000 to 0.000.

### Scaling ±1mA Analog Outputs

Programming engineering scales for directional ±1mA analog outputs depends on whether the output parameter represents unsigned (as volts and amps) or signed (as powers and power factor) values.

For an unsigned output value, you can change both zero and full engineering scales.

For a signed (directional) value, you should only provide the engineering scale for the +1 mA output current.

The engineering scale for the 0 mA output current is always equal to zero for all values except the signed power factor, for which it is set to 1.000 (see [Scaling Directional Power Factor](#) above).

The meter does not allow access to the low scale setting if the parameter is directional. Whenever the sign of the output parameter is changed to negative, the meter automatically uses the full engineering scale setting for +1 mA with a negative sign.

### **Scaling Analog Outputs for 0-2 mA and $\pm 2$ mA**

The 0-1mA and  $\pm 1$ mA current outputs provide a 100% overload, and actually output currents up to 2 mA and  $\pm 2$ mA whenever the output value exceeds the engineering scale you set for the 1 mA or  $\pm 1$ mA.

The output scales for 0-1 mA and  $\pm 1$  mA analog outputs are programmed for 0 mA and +1 mA regardless of the required output current range.

To use the entire output range of 2 mA or  $\pm 2$  mA, set the analog output scales as follows:

- **0-2 mA:** set the 1 mA scale to  $\frac{1}{2}$  of the required full scale output for uni-directional parameters, and set the 0 mA scale to the negative full scale and the 1 mA scale to zero for bi-directional parameters.
- **$\pm 2$  mA:** set the 1 mA scale to  $\frac{1}{2}$  of the required full-scale output for both uni-directional and bi-directional parameters.

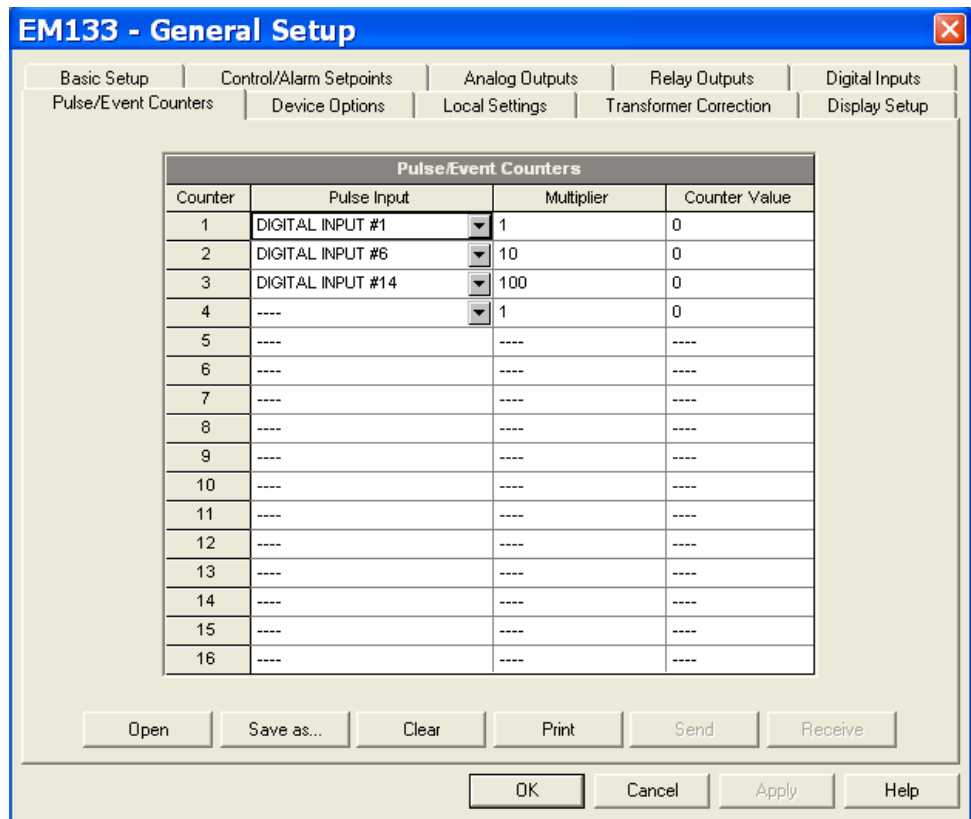
For example, to provide the 0 to 2 mA output current range for Volts measured by the meter in the range of 0 to 120V, set the 1 mA scale to 60V; then the 120V reading will be scaled to 2 mA.

## **Configuring Counters**

The EM13X Series has four six-digit general counters that can count pulses delivered through the device digital inputs with a programmable scale factor. Each counter can also be incremented in response to any internal or external event, checked and cleared through the Control Setpoints.

### **Using PAS**

Select **General Setup** from the **Meter Setup** menu, and then click on the **Pulse/Event Counters** tab.



**Figure 5-11: General Setup Dialog Box – Pulse/Event Counters**

Table 14 lists available counter options.

**Table 14: Counter Options**

Option	Range	Default	Description
Pulse Input	None, DI1 DI2 DI3 DI4 DI5 DI6 DI7 --- DI14	None	Links a digital input to the counter
Multiplier	1-9999	1	The value added to the counter when a pulse is detected on the pulse source input
Counter Value			Displays the present counter contents

You can preset a counter to a required value or clear it without affecting the counter setup.

**To preset or clear a counter:**

- Click the Online button on the PAS toolbar before accessing the setup dialog box.
- Type in the required value into the **Counter Value** field
- Click **Send**

## Configuring Alarm/Control Setpoints

The EM13X Series has an embedded logical controller that can perform different actions in response to user-defined internal and external events. Unlike a PLC, the meter uses a simplified programming technique based on setpoints that allows the user to define a logical expression based on measured analog and digital values that produce a required action.

The meter provides 16 control setpoints with programmable operate and release delays. Each setpoint evaluates a logical expression with one trigger argument. Whenever an expression is evaluated as "true", the setpoint performs a programmable action that can send a command to the output relay, or increment a counter.

The logical controller provides very fast response to events. The scan time for all setpoints is 1 cycle time (16.6 ms at 60Hz and 20 ms at 50/400 Hz).

### Using PAS

Select **General Setup** from the **Meter Setup** menu, and then click on the **Control/Alarm Setpoints** tab.

Control/Alarm Setpoints						
No.	Trigger parameter	Operate limit	Release limit	Operate delay	Release delay	Action
1	MINUTE INTERVAL	15	NONE	0.0	0.0	DATA LOG #1
2	LO VOLT AVR	14200	14298	1	5	OPERATE REL #1
3	HI AMPS AVR	2500	2400	2	5	OPERATE REL #2
4	STAT INP #5 ON	NONE	NONE	0.0	0.0	INC CNT #1
5	STAT INP #6 ON	NONE	NONE	0.0	0.0	INC CNT #2
6	----	----	----	----	----	----
7	----	----	----	----	----	----
8	----	----	----	----	----	----
9	----	----	----	----	----	----
10	----	----	----	----	----	----
11	----	----	----	----	----	----
12	----	----	----	----	----	----
13	----	----	----	----	----	----
14	----	----	----	----	----	----
15	----	----	----	----	----	----
16	----	----	----	----	----	----

**Figure 5-12: General Setup Dialog Box – Control/Alarm Setpoints Tab**

The following table lists the available setpoint options.

**Table 15: Setpoint Options**

Option	Range	Description
Trigger parameter	See Appendix C	The trigger parameter that is used as an argument in the logical expression
Operate limit		The threshold (in primary units) at which the conditional expression would be evaluated to true. Not applicable for digital triggers.
Release limit		The threshold (in primary units) at which the conditional expression would be evaluated to false. Defines the hysteresis for analog triggers. Not applicable for digital triggers.
Operate delay	0.1-999.9 sec	The time delay before operation when the operate conditions are fulfilled
Release delay	0.1-999.9 sec	The time delay before release when the release conditions are fulfilled
Action	See Appendix C	The action performed when the setpoint expression is evaluated to true (the setpoint is in operated state)

### Using Numeric Triggers

For numeric (analog) triggers, you can specify two thresholds for each trigger to provide hysteresis (dead band) for setpoint operations.

The Operate Limit defines the operating threshold, and the second Release Limit defines the release threshold for the trigger. The trigger thresholds are specified in primary units.

If you do not want to use hysteresis for the trigger, set the Release Limit to the same value as the Operate Limit.

### Using Binary Triggers

Binary (digital) triggers like digital inputs and relays are tested for ON/CLOSED or OFF/OPEN status.

In the PM130, the binary events are level-sensitive events. An event is asserted all the time while the corresponding condition exists.

### Delaying Setpoint Operations

Two optional delays can be added to each setpoint to extend monitoring triggers for a longer time before reaching a decision on whether the expected event occurred or not. When a delay is specified, the logical controller changes the setpoint status only if all conditions are asserted for a period of at least as long as the delay time.

### Using Setpoint Events and Actions

When a setpoint status changes, i.e., a setpoint event is either asserted or de-asserted, the following happens in your meter:

- The new setpoint status is logged to the setpoint status register that can be monitored through communications from the SCADA system or from a programmable controller in order to give an indication on the expected event.
- The operated setpoint status is latched to the setpoint alarm latch register that can be inspected through communications and via the display (see [Status Display](#) in Chapter 3). The register holds the last

setpoint alarm status until it is explicitly cleared through communications or via the display.

- A programmable action is performed on setpoint status transition when a setpoint event is asserted.

Generally, setpoint actions are performed independently for each setpoint and can be repeated a number of times for the same target. The exceptions are relay operations that are shared for each target relay between all setpoints using an OR scheme.

A relay output is operated when one of the setpoints linked to the relay is activated and remains operated until all of these setpoints are released (except for latched relays that require a separate release command to be deactivated).

### **Using Time Counters**

Any of the general counters can be used to count the setpoint operation time. If you select the **TIME CNT n** action for a setpoint, the target counter measures the time while the setpoint is in the operated state. The counter resolution is 0.1 hour. See [Status Display](#) in Chapter 3 on how to examine the counters via the front display.

## Configuring the Display

This setup allows configuring the meter display. It also has an entry for launching the meter Flash Loader.

### Using the Front Display



Select the **Disp** entry from the main menu. See [Viewing and Changing Setup Options](#) in Chapter 3 for information on configuring parameters via the front display.

See Table 16 for the available options.

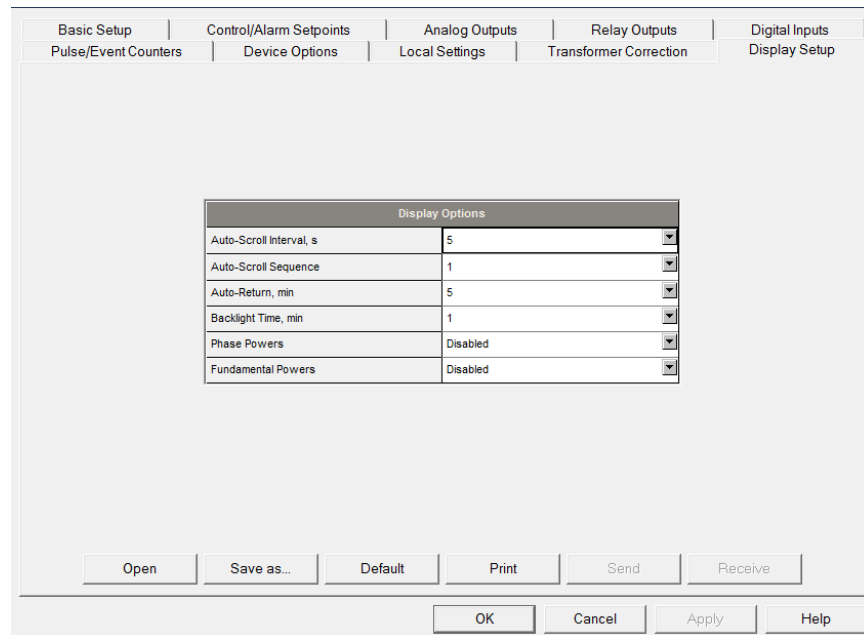
**Table 16: Display Setup Options**

Display Label	Parameter	Options	Default	Description
AutuoScroll	Display update rate	Disabled 2 – 30sec	5 sec	Defines the interval between display updates
AutoReturn	Auto return to the main screen	Disabled, 1 – 30 mn	5 mn	Enables automatic return to the main display if no buttons are pressed for 5 minutes
Backlight	Display Backlight period	Continuous, 1 – 10 mn	1	Defines the display backlight light on time duration
Phas.Power	Phase powers display mode	Enabled Disabled	Disabled	Disables or enables phase powers in the main display
Fund.Power	Fundamental component display mode	Enabled Disabled	Disabled	Disables or enables fundamental values in the main display



## Using PAS

Select General Setup from the Meter Setup menu, and then click on the Display Setup tab.



**Figure 5-13: General Setup Dialog Box – Display Setup Tab**

The available options are listed in the table 17 below.

See [Display Operations](#) in Chapter 3 for more information on display functionality and configuring display options. See [Data Displays](#) for information on display page contents and enumeration.

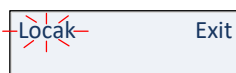
Table 17: Display Setup Options

Display Label	Parameter	Options	Default	Description
Auto-Scroll	Auto-Scroll Interval	Disabled, 2-10, 15, 20, 25, 30 seconds	5	Defines the display scroll interval or disables auto-scroll
Scroll Seq.	Auto-Scroll Sequence	1 1-2 to 1-7 1, 5 1, 5-6, 1, 5-7, 1-2, 5-7 1-3, 5-7 1, 6-7 1-2, 6-7 1-3, 6-7 1-4, 6-7 1, 7 1-2, 7 1-3, 7 1-4, 7 1-5, 7 3 3-4 3-5 3-6 3-7 3, 5 3, 5-6 3, 5-7 3, 7 5 5-6 5-7 5,7	1	Selects the display sequence for auto-scrolling from 9 data displays (see <a href="#">Data Displays</a> for display enumeration)
Auto-Return	Auto-Return	Disabled, 1-5, 10, 15, 20, 25, 30 min	5	Defines the time delay before returning to the default page
Backlight	Backlight Time	Continuous, 1-10 min	1	Defines the time while the backlight is ON
Phase Power	Phase powers display mode	Enabled Disabled	Disabled	Disables or enables phase powers in the main display
Fundamental Power	Fundamental component display mode	Enabled Disabled	Disabled	Disables or enables fundamental values in the main display

## Local Time Settings

This setup allows you to specify your time zone, daylight saving time, and clock synchronization options.

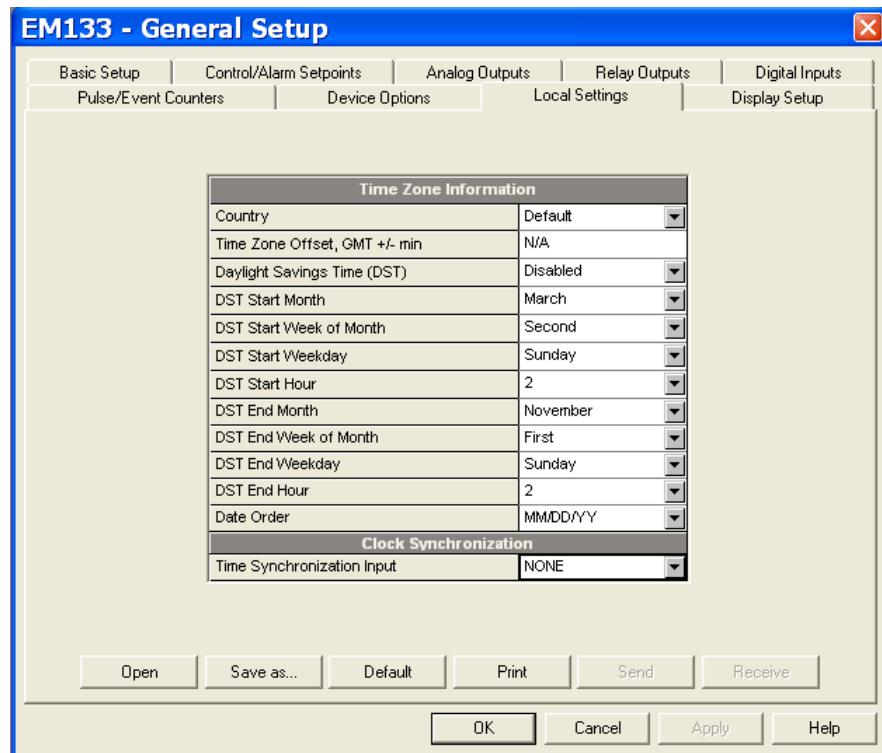
### Using the Front Display



Select **Local** from the main menu. See [Viewing and Changing Setup Options](#) in Chapter 3 for information on configuring parameters via the front display.

### Using PAS

Select **General Setup** from the **Meter Setup** menu, and then click on the **Local Settings** tab.

**Figure 5-14: General Setup Dialog Box – Local Settings Tab**

The available options are described in Table 18.

**Table 18: Local Time Options**

Display Label	Parameter	Options	Default	Description
Date Order	Day/month/year order	DD/MM/YY MM/DD/YY YY/MM/DD	DD/MM/YY	Defines date order presentation
Country	Country code	Default, or country name	Default	Defines calendar setting. The default setting stands for the U.S.A.
Daylight	Daylight Saving Time	Disabled Enabled	Disabled	When DST is disabled, the RTC operates in standard time only. When enabled, the meter automatically updates the time at the pre-defined DST switch dates.
Start Mon	DST Start Month	January to December	March	The month when Daylight Saving Time begins.
Start Week	DST Start Week	1 <sup>st</sup> to 4 <sup>th</sup> and last	Second	The 2 <sup>nd</sup> week of the month when Daylight Saving Time begins.
Start Day	DST Start Day	The weekday	Sunday	The 2 <sup>nd</sup> Sunday of the month when Daylight Saving Time begins.
Start Hour	DST Start Hour	1-6	2	The hour when Daylight Saving Time begins.
dSt.E	DST End Weekday	Month-week-weekday Week = 1, 2, 3, 4 or L (last week of the month)	First Sunday in November	The date when Daylight Saving Time ends.
End Mon	DST End Month	January to December	November	The month when Daylight Saving Time ends.

Display Label	Parameter	Options	Default	Description
End Week	DST End Week	1 <sup>st</sup> to 4 <sup>th</sup> and last	First	The 1 <sup>st</sup> week of the month when Daylight Saving Time ends.
End Day	DST End Day	The weekday	Sunday	The 1 <sup>st</sup> Sunday of the month when Daylight Saving Time ends.
End Hour	DST End Hour	1-6	2	The hour when Daylight Saving Time ends.
Clock Sync	Time Synchronization Input	None DI1 1PPM DI2 1PPM DI3 1PPM DI4 1PPM DI5 1PPM DI6 1PPM DI7 1PPM ... DI14 1PPM	None	The external port receiving the time synchronization pulses

### Daylight Saving Time

When the daylight saving time is enabled, the meter automatically advances the device clock by one hour when daylight saving time begins and puts the clock back one hour when it ends. The default daylight saving time change points are preset for the U.S.A.

The daylight saving time option is disabled in the PM130 by default. If the daylight saving time option is disabled, you need to manually adjust the device clock for daylight saving time.

### Time Synchronization Pulses

External time synchronization pulses can be delivered through one of the digital inputs.

If a digital input is selected as the time synchronization source, the edge of an external pulse adjusts the device clock at the nearest whole minute. The time accuracy could be affected by the debounce time of the digital input, and by the operation delay of the external relay.

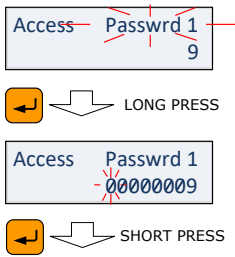
## 5.3 Configuring Meter Security

This setup allows changing the user password and enabling or disabling password protection. The EM13X Series provides 3 configurable passwords.

The password in your meter is preset to 0 at the factory, and password protection is disabled.

### Using the Front Display

Select the **Access** entry from the main menu. See [Viewing and Changing Setup Options](#) in Chapter 3 for information on configuring parameters via the front display.

**To change the password:**

- Apply LONG PRESS on ENTER button to select the **Passwr d 1** entry
- Apply SHORT PRESS on ENTER button to select the password digit to change.
- Apply LONG PRESS on ENTER button to exit the **Passwr d 1** digit field
- Apply LONG PRESS on ENTER button to exit the **Passwr d 1** field to move to **Access** field



The new password is effective for both the display and communication ports.

**Using PAS**

Ensure that the **On-line** button on the PAS toolbar is checked, select **Administration** from the **Monitor** menu, and then select **Change Password -> Password 1**.



An **Authorization Required** dialog box will ask for administrator password to access the **Change Password** menu.



**Figure 5-15: Password Setup Dialog Box**

**To change the password:**

- Type in a new 8-digit password
- Repeat the password in the **Confirm new password** box
- Click **Send**

## 5.4 Configuring Billing/TOU

### Billing Energy Registers

The EM13X Series has 4 fully programmable billing energy registers that can be linked to any internal energy source or to an external pulse source that delivers pulses through the meter digital inputs.

Any energy register can provide either a single-tariff energy accumulation or be individually linked to the TOU system providing both total and multi-tariff energy billing.

### Tariff Rates

The meter tariff structure supports 8 different tariff rates using an arbitrary tariff schedule. A total of 4 types of days and 4 seasons are supported with up to eight tariff changes per day.

### Maximum Demand Registers

Any of billing energy registers can be individually linked to the maximum demand register providing the same demand tariff structure as you selected for energy registers.

### Recording Billing Data and Load Profiling

The EM13X Series can provide automatic recording of the daily energy and maximum demand profile to a data log file. Maximum demand profiling can be individually configured for every register.

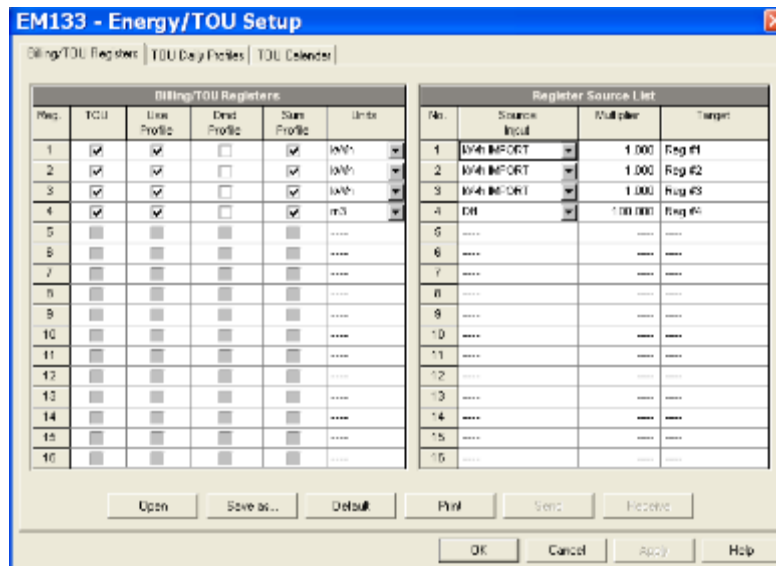
See [Factory Preset Data Log Files](#) in Chapter 5 and [Billing Profile Log File](#) in Appendix E for more information on the file layout and contents.

#### To configure the billing registers and the tariff system in your meter:

- Link the billing registers to the respective energy sources.
- Configure the options for the registers to whether the only totalization or both total and tariff registers would be used, and whether daily profiling should be enabled for the energy usage and maximum demand registers.
- Configure the daily tariff schedule using the TOU daily profiles for all types of days and seasons.
- Configure the season tariff schedule using the TOU calendar.

### Configuring Billing/Tariff Registers

- To configure the billing/TOU registers in your meter:
  - Select **Energy/TOU** from the **Meter Setup** menu.



**Figure 5-16: Energy/TOU Setup Dialog Box – Billing/TOU Registers tab**

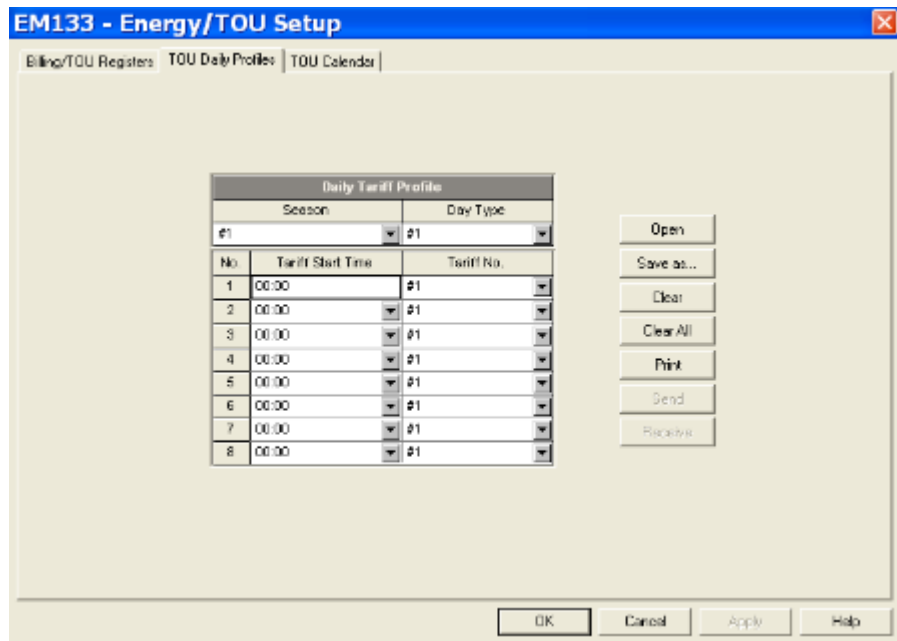
- Configure the register options according to the valid parameters shown in Table 19.

**Table 19: Billing/TOU Register Options**

Parameter	Options	Default	Description
<b>Billing/TOU Registers</b>			
TOU	Unchecked Checked	Unchecked	Links tariff registers to the selected energy source
Use Profile	Unchecked Checked	Checked	Enables recording energy registers in a daily billing profile file (both total and tariff registers if TOU is enabled).
Dmd Profile	Unchecked Checked	Unchecked	Enables recording maximum demand registers in a daily billing profile file (both total and tariff registers if TOU is enabled)
Sum Profile	Unchecked Checked	Checked	Enables recording total (summary) registers in a daily billing profile file.
Units	kWh, kvarh, kVAh, m <sup>3</sup> , CF (cubic foot), CCF (hundred cubic feet)	None	The register measurement units. When a register is linked to an internal energy source, it is set automatically. When an external pulse source is used, the user can select a measurement unit for the register.
<b>Register Source List</b>			
Source Input	None kWh Import kWh Export kvarh Import kvarh Export kvarh Q1-Q4 kVAh Total kVAh Import kVAh Export kWh L1 Import kWh L2 Import kWh L3 Import DI1-DI14	None	Links an energy source to the register
Multiplier	0.001 to 100.000	1.000	The multiplication factor for the energy source. Unchangeable for internal energy sources.
Target	Reg# 1- Reg#4	None	Defines the target billing register for the energy source. It is set automatically.

## Configuring the Daily Tariff Schedule

To configure your daily tariff schedule, select **Energy/TOU** from the **Meter Setup** menu, and then click on the **TOU Daily Profiles** tab.



**Figure 5-17: Energy/TOU Setup Dialog Box – TOU Daily Profiles Tab**

The daily profile setup allows you to specify the daily tariff change points with a 15-minute resolution for 4 seasons using 4 different daily schedules for each season.

### To configure your daily profiles:

- Select the desired season and day type.
- Select the start time for each tariff change point and the corresponding active tariff number.
- Repeat the setup for all active profiles.
- The first tariff change point is fixed at 00:00 hours, and the last tariff change you specified will be in use until 00:00 hours on the next day.

### NOTE

The billing daily profile log file is automatically configured for the number of active tariffs you defined in the meter TOU daily profiles.



## Configuring the Season Tariff Schedule

To configure your season tariff schedule, select **Energy/TOU** from the **Meter Setup** menu, and then click on the **TOU Calendar** tab.

No.	Season/Period	Day Type	Week of Month	Weekday	Till Weekday	Month	Day	Till Month	Till Day
1	#1	#1	----	Monday	Friday	----	----	----	----
2	#1	#2	----	Saturday	Sunday	----	----	----	----
3	#1	#2	----	----	----	January	1	----	----
4	#1	#2	Last	Monday	----	May	----	----	----
5	#1	#2	----	----	----	July	4	----	----
6	#1	#2	First	Monday	----	September	----	----	----
7	#1	#2	Fourth	Thursday	----	November	----	----	----
8	#1	#2	----	----	----	December	25	----	----
9	----	----	----	----	----	----	----	----	----
10	----	----	----	----	----	----	----	----	----
11	----	----	----	----	----	----	----	----	----
12	----	----	----	----	----	----	----	----	----
13	----	----	----	----	----	----	----	----	----
14	----	----	----	----	----	----	----	----	----
15	----	----	----	----	----	----	----	----	----
16	----	----	----	----	----	----	----	----	----

**Figure 5-18: TOU Calendar Setup Dialog Box – TOU Calendar Tab**

The meter TOU calendar allows you to configure any tariff schedule based on any possible utility regulation. The calendar provides 32 entries that allow you to specify profiles for working days and holidays through all seasons in any order that is convenient for you, based on simple intuitive rules.

### To configure your season tariff schedule:

In the **Season/Period** box, select the season, and in the **Day Type** box, select a day type for this calendar entry.

Define the time interval when this daily tariff schedule is effective, based on the start and end weekdays and, for a multi-season schedule, on the start and end month for the selected season. It does not matter which order of weekdays or months you select: the meter recognizes the correct order.

For exception days like weekends and designated holidays, define a specific day either by a month and a month day, or by selecting a month, a week and a weekday within the month.

There are no limitations on how to build your schedule. A common recommendation is to use minimum time constraints and only when it is needed to avoid ambiguity. You need not to define month days if a daily schedule is effective all days of the month, or to define the start and end months if it is effective through all the year. If you wish to define a specific period within a month using the start and end days, put this entry before allocating the remaining days to another daily schedule without specified month days, so it would be checked first for a match.

The above picture shows a typical single-season tariff schedule with two daily tariff profiles configured for working days, and weekends and the designated U.S.A. holidays.

## 5.5 Configuring Recorders

The EM13X Series has a 125-KByte onboard non-volatile memory for data and event recording. The memory is fully configurable and can be freely partitioned between log files.

The meter provides memory for a total of 3 log files:

- Event log
- Two data logs

The two data log files are pre-configured at the factory for recording a 15-minute energy and demand profile and for the daily billing energy data profile. If you wish to change the factory settings, follow the guidelines in the next section.

### Configuring Meter Memory

To view the present memory settings, select **Memory/Log** from the **Meter Setup** menu, and then click on the **Log Memory** tab.

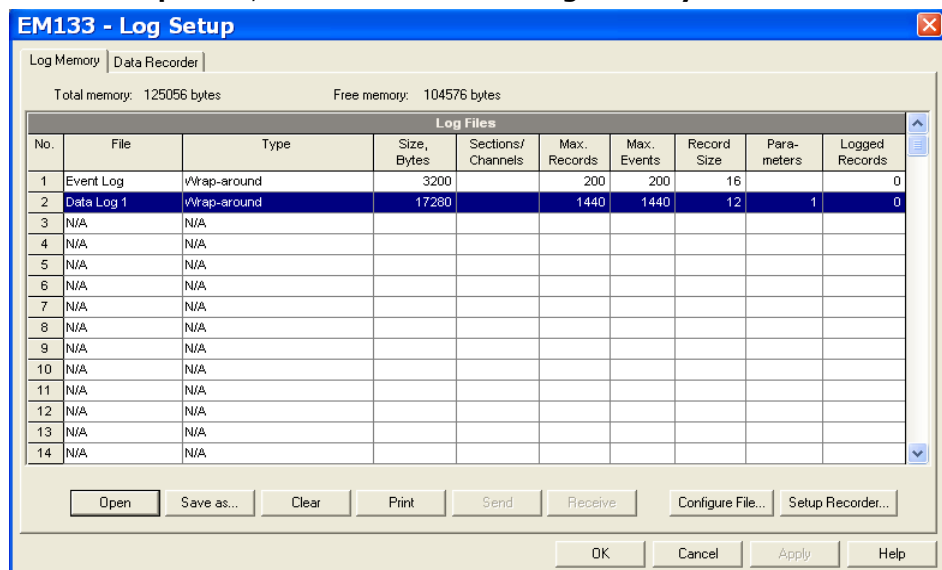


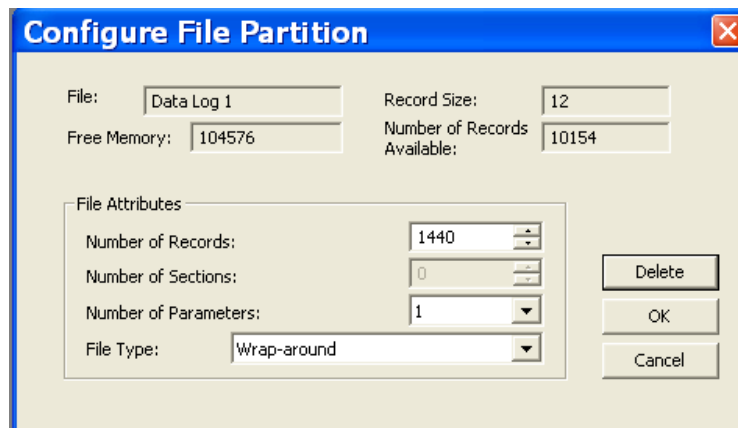
Figure 5-19: Log Setup Dialog Box – Log Memory Tab

The following table describes file options.

Option	Range	Description
Type	Wrap-around Non-wrap	Wrap-around: recording continues over the oldest records. Non-wrap: recording is stopped until the file is cleared.
Size		The size of memory allocated to the file.
Sections/Channels	0-8	The numbers of sections in a multi-section profile data log file
Num. of Records	0-65535	Allocates the file memory for predefined number of records
Record size		The size of the file record for a single channel or a single section. It is set automatically depending on the file and on the number of parameters in the data records
Parameters	0-9	The number of parameters in a single data log record

**To change the file properties or to create a new file:**

- Double click on the file you want to change.



- Select desired parameters for your log.
- Click **OK**.

For your reference, the record size and the number of records available for your file are reported in the dialog box.

**To delete an existing file partition:**

- Click on **Delete**.
- Click **OK**.

**NOTES**

- Memory is allocated for a file statically when you set up your files and will not change unless you re-organize files.
- The meter automatically performs de-fragmentation of the memory each time you re-organize your files. This prevents possible leakage of memory caused by fragmentation. It may take a couple of seconds.

For more information on configuring specific files, see the following sections.

The following table can help you calculate an estimated file size when planning your memory allocation.

<b>File</b>	<b>Record Size, Bytes</b>	<b>File Size, Bytes</b>
Event Log	16	Record size × Number of records
Conventional data Log	12 + 4 × Number of parameters	Record size × Number of records
Billing/TOU daily profile log	12 + 4 × (Number of season tariffs + 1 for the TOU summary/total register)	Record size × Number of billing registers (× 2 for the maximum demand profile) × Number of records

The factory pre-set file configuration is shown in the following table.

<b>No.</b>	<b>File</b>	<b>Size, Bytes</b>	<b>Channels</b>	<b>Number of Records</b>	<b>Number of Events</b>	<b>Factory-set Configuration</b>
1	Event log	3200		200	200	200 last events
2	Data log #1	46080		5760	5760	15-min data profile for 15 days
17	Data log #16	8640	4	90	90	Daily billing/TOU profile for 90 days, 4 registers, totals + 3 tariffs

## Configuring the Event Recorder

To configure the Event log file:

Double click on the Event Log file partition with the left mouse button.

The screenshot shows a 'Configure File Partition' dialog box. At the top, the title bar reads 'Configure File Partition' with a close button. Below the title bar, there are four input fields: 'File:' with the value 'Event Log', 'Record Size:' with '16', 'Free Memory:' with '128', and 'Number of Records Available:' with '208'. Below these is a 'File Attributes' section containing four dropdown menus: 'Number of Records:' set to '200', 'Number of Sections:' set to '0', 'Number of Parameters:' set to 'NONE', and 'File Type:' set to 'Wrap-around'. To the right of these dropdowns are three buttons: 'Delete', 'OK', and 'Cancel'.

Select a desired file type for your file.

Select the maximum number of records you want to be recorded in the file.

Click OK, then send your new setup to the meter or save to the device database.

By default, the Event recorder stores all events related to configuration changes, resets, and device diagnostics.

## Configuring the Data Recorder

### Conventional Data Log Files

The Data recorder is programmable for recording up to 9 data parameters per record in each of the conventional data log files. The list of parameters to be recorded to a data log is configurable individually for each file.

To create a new data log file or re-configure an existing file:

Double click on the file partition with the left mouse button.

The screenshot shows a 'Configure File Partition' dialog box. At the top, the title bar reads 'Configure File Partition' with a close button. Below the title bar, there are four input fields: 'File:' with the value 'Data Log 1', 'Record Size:' with '12', 'Free Memory:' with '128', and 'Number of Records Available:' with '9010'. Below these is a 'File Attributes' section containing four dropdown menus: 'Number of Records:' set to '9000', 'Number of Sections:' set to '0', 'Number of Parameters:' set to '1', and 'File Type:' set to 'Wrap-around'. To the right of these dropdowns are three buttons: 'Delete', 'OK', and 'Cancel'.

Select a partition type for your file.

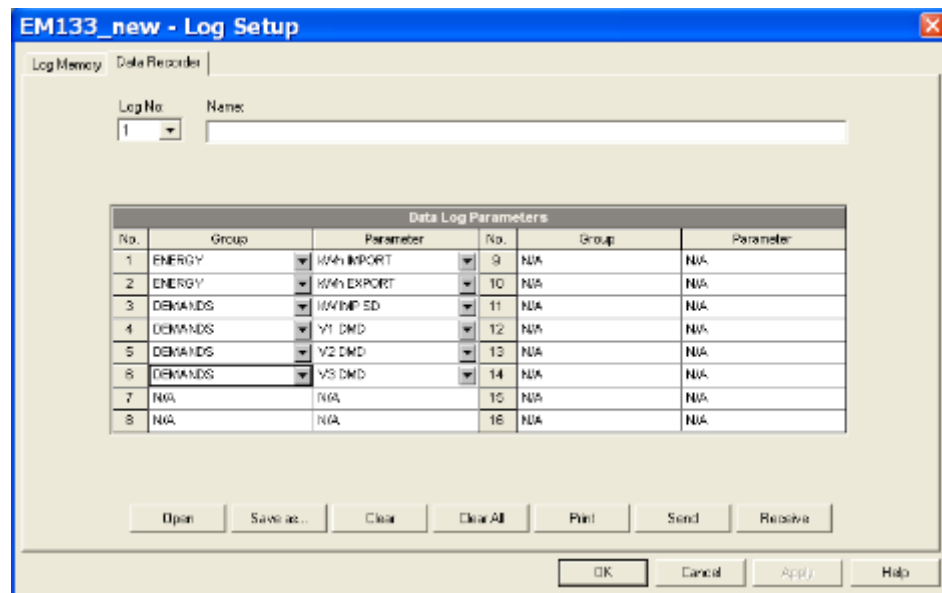
Select the number of parameters you want to be recorded in the file records.

Select the maximum number of records you want to be recorded in the file.

Click **OK**, and then send your new setup to the meter, or save to the device database.

To define the contents of the file:

Highlight the data log file row with the left mouse button, and then click on the **Setup Recorder** button, or click on the **Data Recorder** tab and select the corresponding log number.



**Figure 5-20: Log Setup Dialog Box – Data Recorder Tab**

Configure the list of parameters to be recorded in a log file. You are not allowed to select more parameters than you defined when configuring your file. Refer to Appendix D for a list of available parameters.

For your convenience, PAS follows your selection and helps you configure a series of the neighboring parameters: when you open the **Group** box for the next parameter, PAS highlights the same group as in your previous selection; if you select this group again, PAS automatically updates the **Parameter** box with the following parameter in the group.

Add the name for your data log file in the **Name** box. It will appear in the data log reports.

Save your new setup to the device database, and send it to the meter.

### **Billing/TOU Daily Profile Log File**

Data log #16 is configurable to store TOU daily profile log records on a daily basis.

The file is organized as a multi-section file that has a separate section of the same structure for each billing energy and maximum demand register. The number of sections is taken automatically from the Billing/TOU Registers setup (see [Configuring Billing/Tariff Registers](#)). If the maximum demand profiling is used, then the number of sections in the file will be twice the number of the allocated billing registers.

#### **To configure a daily profile log file:**

Configure your Billing/TOU registers and tariff schedule in the meter (see [Configuring Billing/Tariff Registers](#)) first.

Double click on the **Data Log#16** partition with the left mouse button.

Select the **TOU Daily Profile** file type.

Select the number of season tariffs in your TOU schedule. Add one additional parameter if you selected to record the Summary (TOU total) registers as well.

Select the maximum number of records you want to be recorded in the file assuming that a new record will be added once a day.

Click **OK** and send your setup to the meter or save to the meter database.

## Factory Preset Data Log Files

### Conventional Data Log #1

Data log #1 is factory preset for 15-min periodic recording of the standard energy and demand quantities. You can freely change the list of recorded parameters and the file update rate.

The default list of parameters is shown in the following table.

No.	Parameter
1	kWh import
2	kWh export
3	kW import sliding demand
4	V1 demand
5	V2 demand
6	V3 demand

Periodic recording data is triggered by Setpoint #1 that is linked to the meter clock. To change the periodic rate at which data is recorded, change the time interval for the MINUTE INTERVAL trigger in Setpoint #1 (see [Configuring Alarm/Control Setpoints](#)).

### Billing/TOU Profile Data Log #16

Data log #16 is pre-configured for daily billing energy and maximum demand recording for the last 90 days. It is automatically updated once a day.

See [Billing Profile Log File](#) in Appendix E for the file record structure.

## 5.6 Configuring Communication Protocols

This section describes how to customize protocol options for use with your application software.

### Configuring Modbus

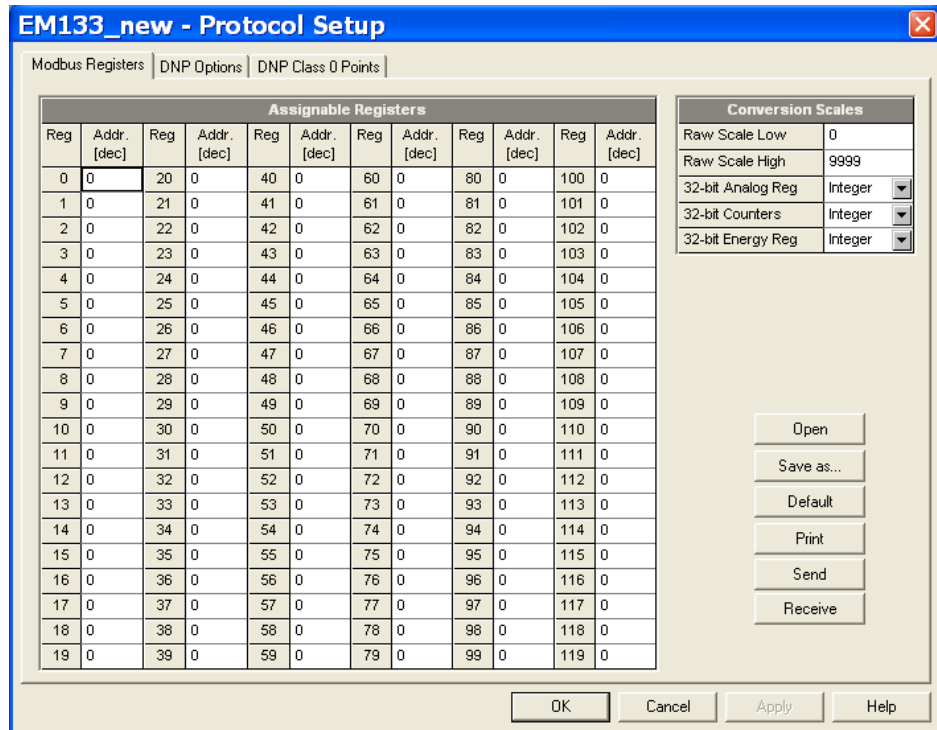
#### Modbus Point Mapping

The EM13X Series provides 120 user assignable registers at addresses 0 to 119. You can re-map any register available in the meter to any assignable register so that registers found at different locations may be accessed with a single request by re-mapping them to adjacent addresses.

Initially these registers are reserved and none of them points to an actual data register. To build your Modbus register map:

Select **Protocol Setup** from the **Meter Setup** menu, and click on the **Modbus Registers** tab.

Click on the **Default** button to cause the assignable registers to reference the actual default meter register 6656 (0 through 119 are not allowable register addresses for re-mapping).



**Figure 5-21 : Protocol Setup Dialog Box – MODBUS Registers Tab**

Type in the actual addresses you want to read from or write to via the assignable registers. Refer to the PM130 PLUS Modbus Reference Guide for a list of the available registers. Note that 32-bit Modbus registers should always start at an even register address.

Click **Send** to download your setup to the meter.

## Changing 32-bit Register Format

The EM13X Series allows you to read 32-bit Modbus analog registers, energy counters and binary counters either in integer format, or in IEEE single precision floating point format.

The 32-bit MODBUS registers are factory-set to integer format. To change the register format:

Select **Protocol Setup** from the **Meter Setup** menu, and click on the **Modbus Registers** tab.

Change the 32-bit register format in the **MODBUS Options** pane.

Click **Send** to download your setup to the meter.

## Configuring DNP3

Refer to the EM13X Series DNP3 Reference guide for information on the DNP3 protocol implementation and a list of the available data points.

### DNP Options

Select **Protocol Setup** from the **Meter Setup** menu and click on the **DNP Options** tab.

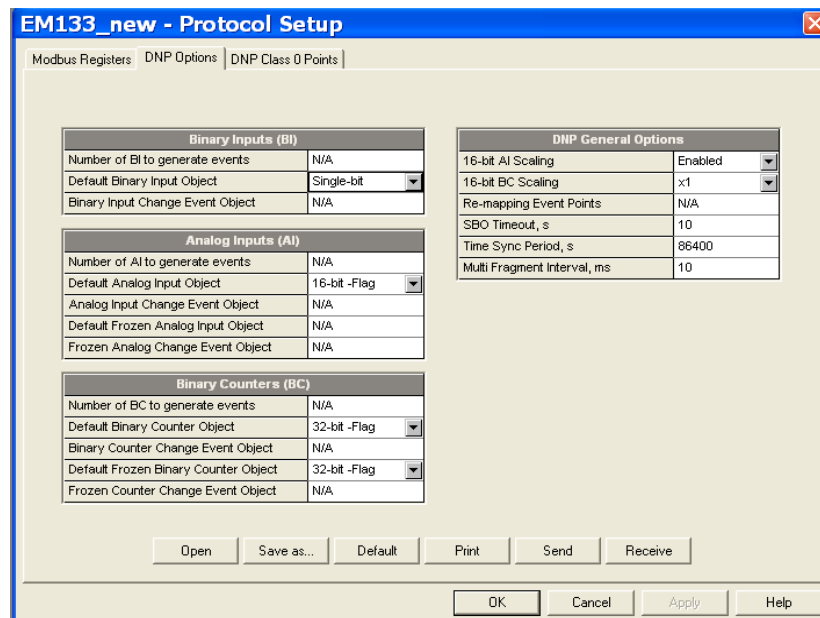


Figure 5-22: Protocol Setup Dialog Box – DNP Options Tab

The following table describes available options. Refer to the DNP3 Data Object Library document available from the DNP User's Group on the DNP3 object types.



**Table 20: DNP Options**

Parameter	Options	Default	Description
<b>Binary Inputs (BI)</b>			
Binary Input Object	Single-bit With Status	Single-bit	The default BI object variation for requests with qualifier code 06 when no specific variation is requested
<b>Analog Inputs (AI)</b>			
Analog Input Object	32-bit 32-bit-Flag 16-bit 16-bit-Flag	16-bit-Flag	The default AI object variation for requests with qualifier code 06 when no specific variation is requested
<b>Binary Counters (BC)</b>			
Binary Counter Object	32-bit+Flag 32-bit-Flag 16-bit+Flag 16-bit-Flag	32-bit-Flag	The default BC object variation for requests with qualifier code 06 when no specific variation is requested
<b>DNP General Options</b>			
16-bit AI Scaling	Disabled Enabled	Enabled	Allows scaling 16-bit analog input objects (see description below)
16-bit BC Scaling	x1, x10, x100, x1000	x1	Allows scaling 16-bit binary counter objects (see description below)
SBO Timeout <sup>1</sup>	2-30 sec	10	Defines the Select Before Operate (SBO) timeout when using the Control-Relay-Output-Block object
Time Sync Period <sup>2</sup>	0-86400 sec	86400	Defines the time interval between periodic time synchronization requests
Multi Fragment Interval	50-500 ms	50	Defines the time interval between fragments of the response message when it is fragmented

**Scaling 16-bit AI objects**

Scaling 16-bit AI objects allows accommodating native 32-bit analog input readings to 16-bit object format; otherwise it may cause an over-range error if the full-range value exceeds a 16-bit point limit.

Scaling is enabled by default. It is not related to points that are read using 32-bit AI objects.

Refer to the PM130 DNP3 Reference Guide for information on the data point scales and a reverse conversion that should be applied to the received scaled values.

**Scaling 16-bit Binary Counters**

Scaling 16-bit Binary Counters allows changing a counter unit in powers of 10 to accommodate a 32-bit counter value to 16-bit BC object format.

<sup>1</sup> The Select Before Operate command causes the meter to start a timer. The following Operate command must be sent before the specified timeout value expires.

<sup>2</sup> The meter requests time synchronization by bit 4 in the first octet of the internal indication word being set to 1 when the time interval specified by the Time Sync Period elapses. The master should synchronize the time in the meter by sending the Time and Date object to clear this bit. The meter does not send time synchronization requests if the Time Sync Period is set to 0.

If the scaling unit is greater than 1, the counter value is reported being divided by the selected scaling unit from 10 to 1000. To get the actual value, multiply the counter reading by the scaling unit.

### Configuring DNP Class 0 Responses

The most common method of getting static object information from the meter via DNP is to issue a read Class 0 request. The EM13X Series allows you to configure the Class 0 response by assigning ranges of points to be polled via Class 0 requests.

#### To view or build a DNP Class 0 response message:

Select **Protocol Setup** from the **Meter Setup** menu and click on the **DNP Class 0 Points** tab.

Select the object and variation type for a point range.

Specify the start point index and the number of points in the range. Refer to the EM13X Series DNP3 Reference Guide for available data points.

Repeat these steps for all point ranges you want to be included into the Class 0 response.

Click **Send** to download your setup to the meter.

The factory-set Class 0 point ranges are shown in the picture below.

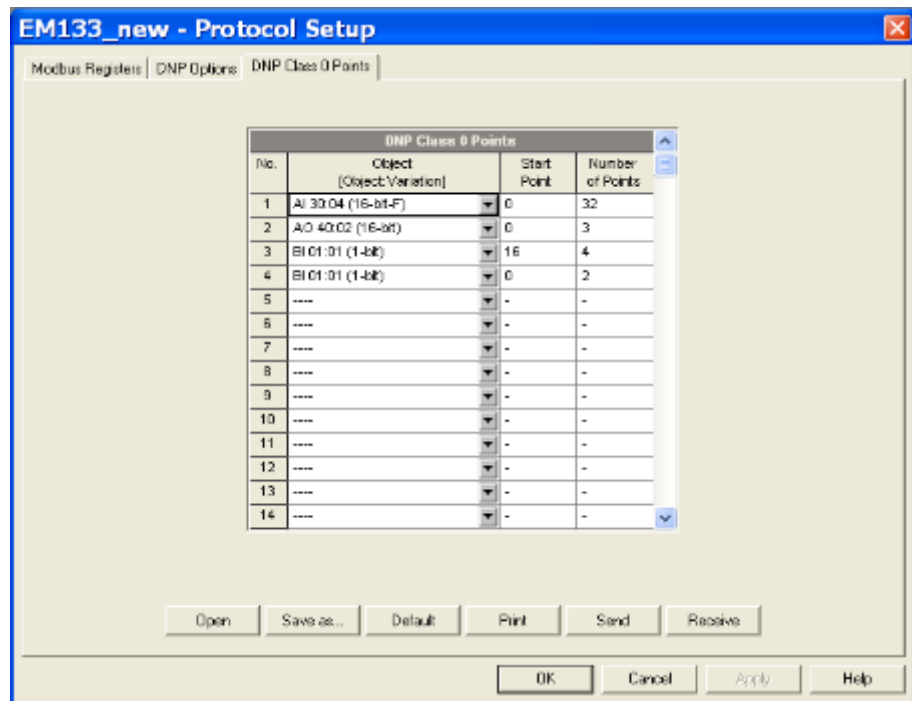


Figure 5-23: Protocol Setup Dialog Box – DNP Class 0 Points Tab

# Chapter 6 Device Control and Upgrading

This section describes operations on the meter you can perform from the front display or via PAS. To access device control options from PAS, you should have your meter online.

## 6.1 Resetting Accumulators, Maximum Values and Files

### Using the Front Display

Select the **RESET** entry from the main menu. See [Viewing and Changing Setup Options](#) in Chapter 3 for information on configuring parameters via the front display.

#### To reset the desired values:

Highlight the middle window by pressing briefly the **SELECT** button.

Select a reset entry by scrolling through the list with the **UP** and **DOWN** arrow buttons.

Press the **SELECT** button briefly to highlight the lower item.

Press and hold the **ENTER** button for 5 seconds.

Release the button.

The **do** entry is replaced with **done** showing the operation is complete.

Table 21 shows the reset options available from the front display.

**Table 21: Front Display Reset Options**

Display Label	Description
Power Dmd	Clears power maximum demands
V/A Dmd	Clears ampere and volt maximum demands
Min/Max	Clears Min/Max log
Counters	Clears all counters
Counter 1 – Counter 4	Clears counter #1-#4
Diagnostics	Clears device diagnostics

### Using PAS

Ensure that the **On-line** button on the PAS toolbar is checked, and then select **Reset** from the **Monitor menu**.



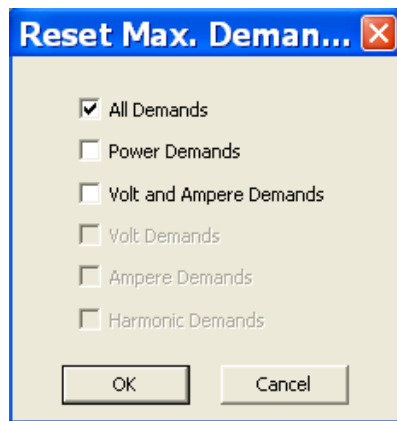
**Figure 6-1: Reset Dialog**

**To reset the desired values or files:**

Click on the corresponding button, and then confirm your command.

If an entry has more than one target, you are allowed to select targets to reset.

Check the corresponding boxes, and then click OK.



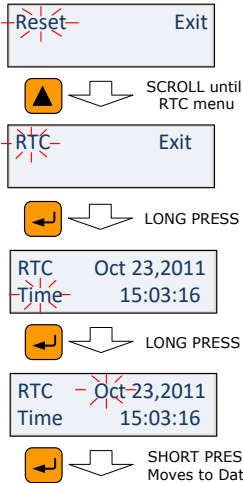
**Figure 6-2: Reset Maximum Demands Dialog Box**

## 6.2 Updating the Meter Clock

### Using the Front Display

Select the **RTC** entry from the main menu.

**To change the time or date:**



When in RTC setup menu, applying a LONG PRESS on the **SELECT/ENTER** button will display the **Time/Date** screen while **Time** willflash. Another LONG PRESS on **SELECT/ENTER** button will flash the actual hour to be changed using **SCROLL** button

Table 22 describes available options.

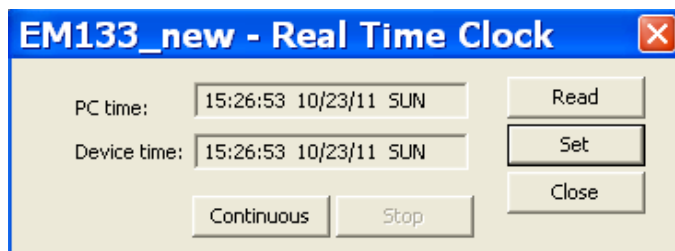
**Table 22: Clock Setup Options**

Display Label	Parameter	Options	Description
Time	Time	Hh:mm:ss	Hours, minutes and seconds are separated by ":". The time is displayed as hh:mm:ss.
Month name	Date	Mon XX, Year	Month/Day Date and year are separated by", ". Where the first three letters represent the month, then the day of the months is represented by two digits and finally the year presented by 4 digits

### Using PAS

Ensure that the **On-line** button on the PAS toolbar is checked, and then select **RTC** from the **Monitor menu** or click on the **Real-Time Clock** button on the PAS toolbar.

The RTC dialog box displays the current PC time and the time in your meter.



**Figure 6-3: Real Time Clock Window**

To synchronize the meter clock with the PC clock, click **Set**.

## 6.3 Viewing and Clearing Device Diagnostics

### Using the Front Display

See [Diagnostics Display](#) in Chapter 3 on how to view and clear device diagnostics from the front display.

### Using PAS

Ensure that the **On-line** button on the PAS toolbar is checked, select **Device Control** from the Monitor menu, and then click on the **Device Diagnostics** tab.

See [Device Diagnostic Codes](#) in Appendix G for the list of diagnostic codes and their meaning.

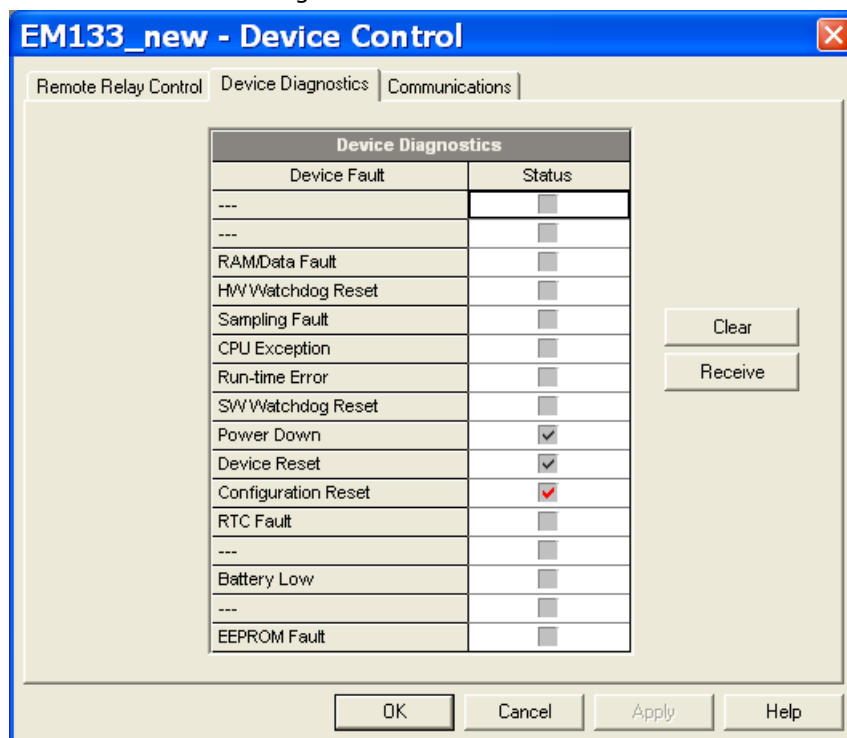
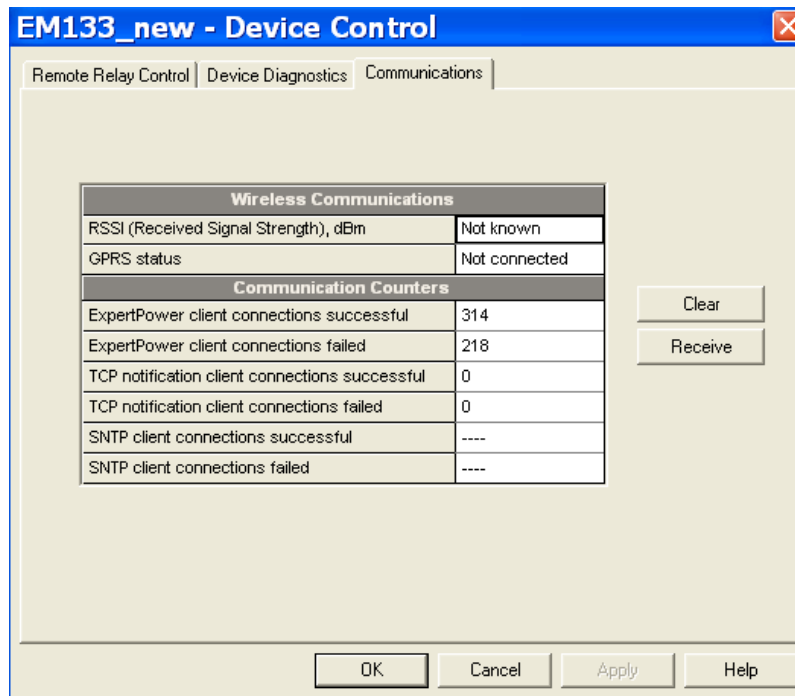


Figure 6-4: Device Control Dialog Box – Device Diagnostics Tab

To clear the device diagnostics events, click on **Clear**.

## 6.4 Viewing Communication Status and Statistics

Ensure that the **On-line** button on the PAS toolbar is checked, select **Device Control** from the Monitor menu, and then click on the **Communications** tab.



**Figure 6-5: Device Control Dialog Box – Communications Tab**

This window indicates the present GPRS communication status (see [Setting Up GPRS Network](#) in Chapter 5) and connection statistics of the TCP clients (see [Setting Up eXpertPower Client](#) and [Setting Up TCP Notification Client](#) in Chapter 5).

To clear the communication counters, click on **Clear**.

You can also clear the communications counters via the PAS Reset dialog (see [Resetting Accumulators, Maximum Values and Files](#)).

## 6.5 Remote Relay Control

You can use PAS to send a remote command to your meter to operate any relay output or release a latched relay, except of the relays linked to an internal pulse source. These relays are blocked for operating from outside of the meter.

To access the relay control dialog, ensure that the **On-line** button on the PAS toolbar is checked, select **Device Control** from the Monitor menu, and then click on the **Remote Relay Control** tab.

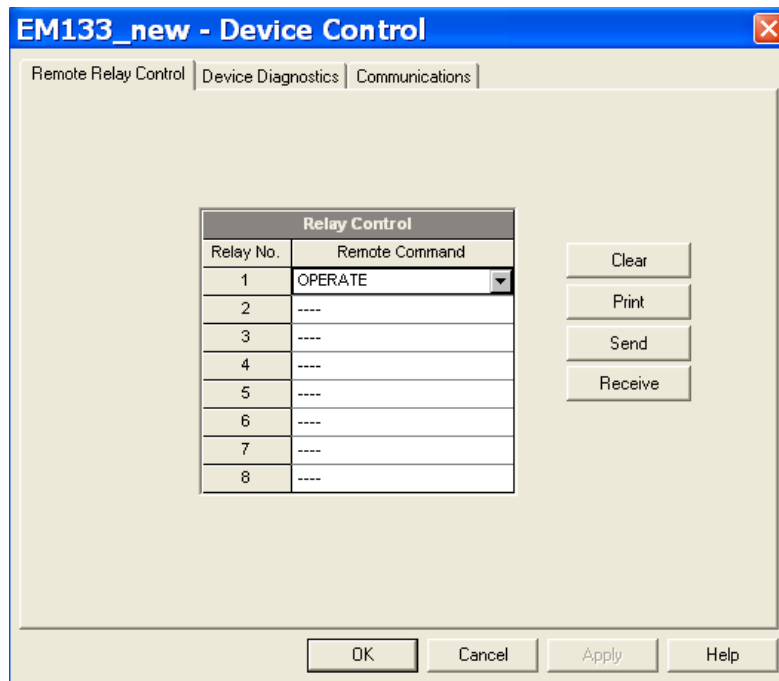


Figure 6-6: Device Control Dialog Box – Remote Relay Control Tab

**To send a remote command to a relay:**

Select a desired command in the **Relay Command** box for a relay:

**OPERATE** – to operate a relay

**RELEASE** – to remove your remote command, or to release a latched relay

Click **Send**.

## 6.6 Upgrading Device Firmware

Your meter has upgradeable firmware. If you need to upgrade your device, download a new firmware file to the meter through PAS.

Firmware can be downloaded via the MODBUS RTU or MODBUS/TCP protocol through any communication port.

**To download a new firmware file to your device:**

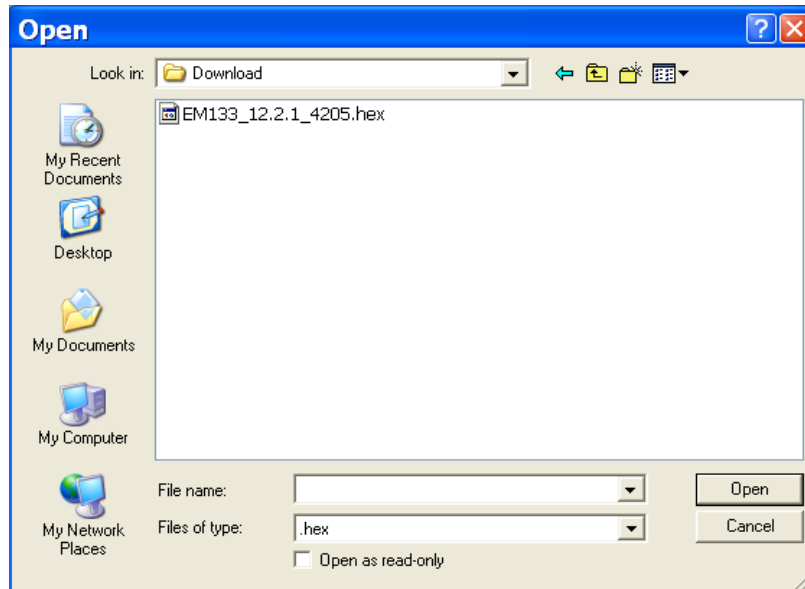
Ensure that the communication port you are connected through to the meter operates in Modbus mode.

If you are connected to the meter through a serial interface, it is recommended to set the port baud rate to 115,200 bps. See [Setting Up Serial Communication Ports](#) on how to remotely change the protocol and baud rate in your meter.

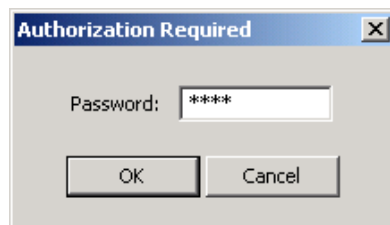
Ensure that the **On-line** button on the PAS toolbar is checked, and then select **Flash Downloader** from the **Monitor menu** and confirm downloading.

Point to the firmware upgrade file for your meter, click Open, and then confirm upgrading the meter.

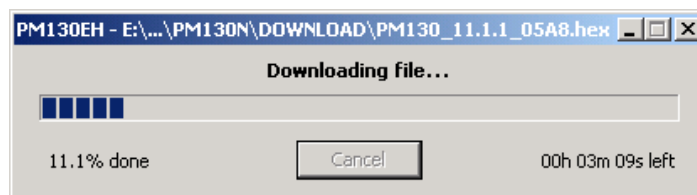




You are asked for the password regardless of the password protection setting in your meter. Type the meter password, and click OK. If you did not change the password in the meter, enter the default password 0.



Wait until PAS completes upgrading your device. It takes about 3-4 minutes at 115,200 bps to download the file to the meter.



After upgrading firmware is completed, the meter restarts, so communications can be temporarily lost. You may need to wait a short duration until PAS restores a connection with your device.



# Chapter 7 Monitoring Meters

## 7.1 Viewing Real-time Data

Real-time data can be continuously retrieved from your devices and updated on the screen at the rate you defined in the Instrument Setup.



To get real-time data from your meter:

Ensure that the **On-line** button on the PAS toolbar is checked.

Select the device site from the list box on the PAS toolbar.

Point to **RT Data Monitor** on the **Monitor** menu, and then select a data set you want to view.

### Polling Devices

Click on the "Poll"  or "Continuous poll"  button to poll the meter once or continuously.

Click on the **Stop** button  to stop continuous polling.

The following picture shows a typical data monitor window.

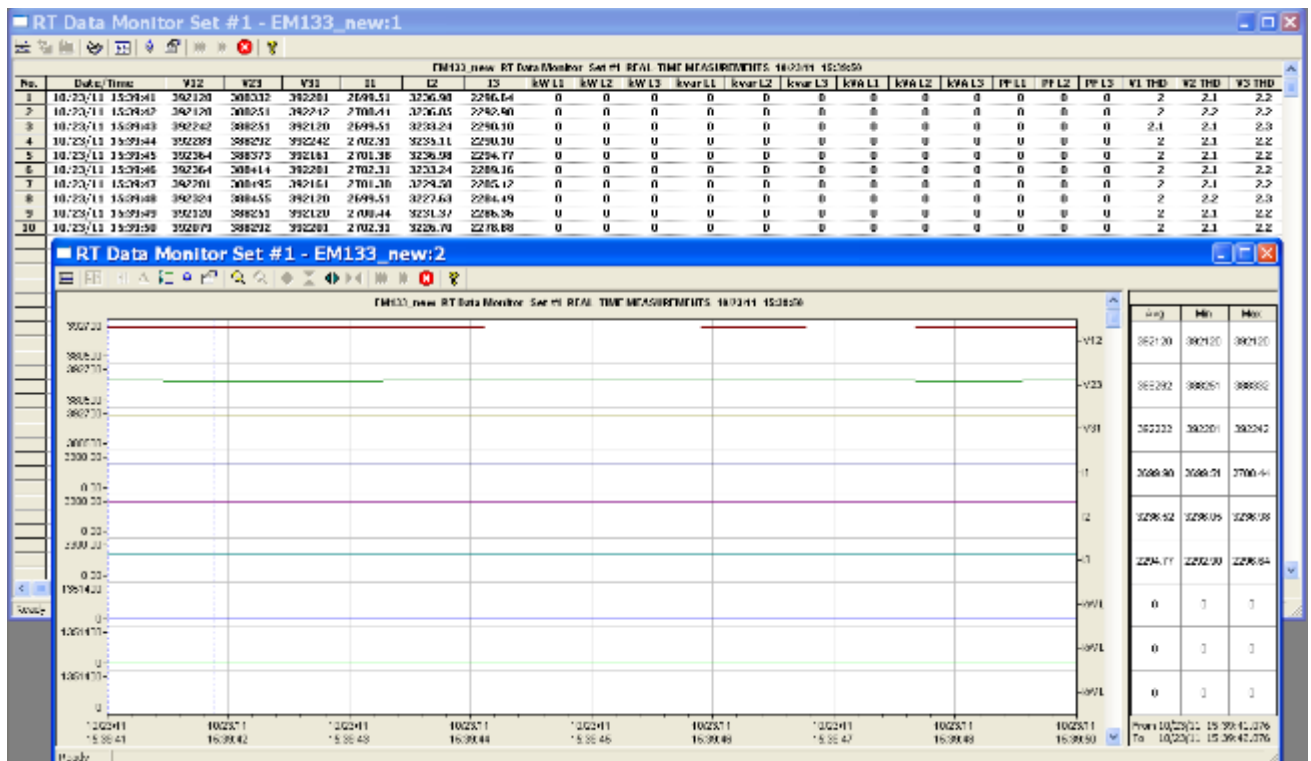



Figure 7-1: RT Data Monitor Window

You can open as many monitor windows as you wish, either for different sites, or for the same site using different data sets. An open data monitor window is linked to the current site and does not change if you select another site in the site list.

You can view acquired data in a tabular form or in a graphical form as a data trend.

## Organizing Data Sets

PAS supports 33 programmable data sets with up to 40 data parameters. Set #0 is intended for simple meters, which have a limited number of parameters, and is not recommended for the use with the EM13X Series. To re-organize data sets, select **RT Data Sets** from the **Monitor** menu or click on the button  on the local toolbar.

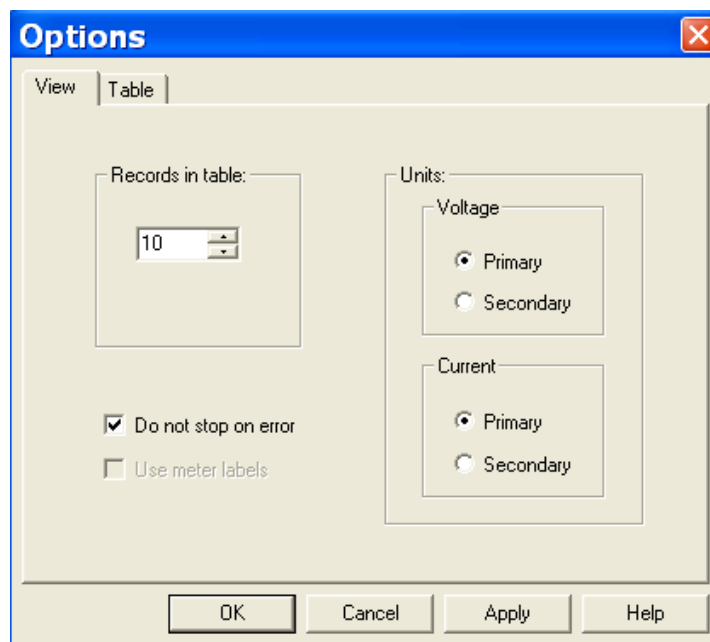
Some data sets are preset for your convenience and others are empty. You can freely modify data sets.

See Appendix D for a list of data available in your meter.

## Polling Options

To change the polling options, click on the Data Monitor window with the right mouse button and select Options.

If you check **Do not stop on errors**, polling is resumed automatically when a communication error occurs, otherwise polling stops until you restart it manually.



## Viewing a Data Table

### Changing the Data View


PAS displays data in either a single record or multi-record view. To change the view, click on the **Data Monitor** window with the right mouse button and select either **Wrap** to see a single record, or **UnWrap** to go to the multi-record view.


### Adjusting the Number of Rows in a Multi-Record View

Click the window with the right mouse button, select Options, adjust the number of records you want to see in the window, and then click OK. When the number of retrieved records exceeds the number of rows in the window, the window scrolls up so that older records are erased.

See [Working with Tables](#) in Chapter 9 for more information on working with tables.


## Viewing Data Trend

To view a data trend, click on the  button on the local toolbar.

To change the time range for your graph, click on the  button on the local toolbar, and then select the desired date and time range.

See [Working with Graphic Windows](#) in Chapter 9 for more information on working with graphs.


## Saving Data to a File

To save retrieved data to a file for later analysis, click on the Save button , select an existing database or type the name for a new database, and then click Save.

To avoid confusion, do not store data files into the **Sites** directory where site databases are located.

## Printing Data

To check the report, as it will look when printed, select **Print Preview** from the **File** menu.

To print retrieved data, click on the  button on the PAS toolbar, select a printer, and then click **OK**.

## Real-time Data Logging

PAS allows you to store data records to a database automatically at the time it updates data on the screen.

To setup the real-time logging options:

Open the **Data Monitor** window.

Click on the **RT Logging On/Off**  button on the local toolbar, or select **RT Logging Options** from the Monitor menu.

Select a database, or type the name for a new database and select a directory where you want to save it.

Select the number of tables, and the number of records in each table you want recorded.

Adjust the file update rate for automatic recording. It must be a multiple of the sampling rate that you defined in the Instrument Setup dialog.

Click **Save**.

When you run real-time data polling, PAS automatically saves retrieved records to a database at the rate you specified.

The **RT Logging On/Off** button  on the toolbar should be checked all the time. You can suspend logging by un-checking the button, and then resume logging by checking it again.

## 7.2 Viewing Real-time Min/Max Log


To retrieve the real-time Min/Max log data from your meter:

Select the device site from the list box on the PAS toolbar.

Point to **RT Min/Max Log** on the **Monitor** menu, and then select a data set you want to view.

Ensure that the **On-line** button  on the PAS toolbar is checked.

Click on the **Poll** button .

PAS supports 9 programmable data sets that you can organize as you wish. To build your data sets, select **MinMax Data Sets** from the **Monitor** menu or click on the  button on the local toolbar.


See [Working with Tables](#) in Chapter 9 for more information on working with tables.



## 7.3 Viewing Real-time Waveforms


To retrieve real-time waveforms from your meter:

Ensure that the **On-line** button  on the PAS toolbar is checked.

Select the device site from the list box on the toolbar.

Select **RT Waveform Monitor** from the **Monitor** menu or click on the  button on the PAS toolbar.

Use the Poll button  for a single-step poll or the Continuous poll  button for continuous polling.

To stop continuous polling, click on the Stop button .

The meter provides simultaneous capture of six one-cycle voltage and current AC waveforms at a rate of 64 samples per cycle. To give you a more representative picture, PAS extends the waveforms across the window up to eight cycles by repeating the captured waveforms.


To select the channels you want to view, click with the right mouse button on the waveform window, select **Channels...**, check the channels for the phase you want displayed, and then click **OK**.


See [Working with Graphic Windows](#) in Chapter 9 for more information on working with waveforms.

Retrieved waveforms can be displayed in different views as overlapped or non-overlapped waveforms, as RMS cycle-by-cycle plot, or as a harmonic spectrum chart or table.

### Viewing a Waveform Graph

When you open a new file, PAS shows you a waveform graph with non-overlapped waveforms as shown in the picture above.

Click on the  button on the local toolbar to see overlapped waveforms.

Click on the  button for non-overlapped waveforms.

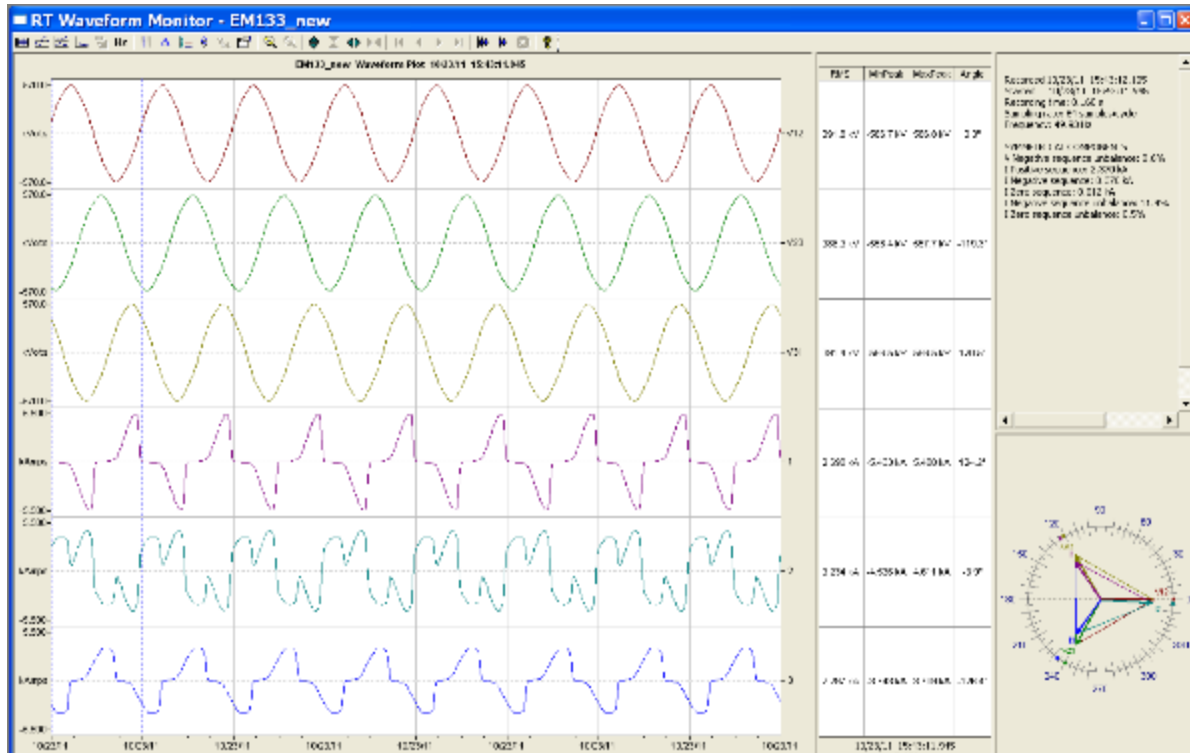



Figure 7-2: RT Waveform Monitor Window

### Viewing a Frequency Plot

Click on the **Hz** button to view a cycle-by-cycle frequency plot for the sampled voltage waveforms.

### Viewing a Harmonic Spectrum

Click on the  button to view a spectrum chart for the selected waveform channel. PAS provides voltage, current, active power and reactive power spectrum charts. See [Viewing Real-time Harmonic Spectrum](#) for more information on viewing options.

### Viewing Phasor Diagrams

The phasor diagrams show you relative magnitudes and angles of the three-phase voltage and current fundamental component. All angles are shown relative to the reference voltage channel.

To change the reference channel, click on the waveform window with the right mouse button, select **Options...**, click on the **Phasor** tab, check the channel you want to make a reference channel, and then click **OK**.


### Viewing Symmetrical Components

Waveform views have an additional pane at the right where PAS displays the symmetrical components for voltages and currents, calculated for the point indicated by the left marker line.

To enable or disable the symmetrical components, click on the waveform window with the right mouse button, select **Options...**, check or uncheck the **Symmetrical components** box on the **Channels** tab, and then click **OK**.

## Viewing Phase-to-phase Voltages

PAS can transform phase-to-neutral voltage waveforms in configurations with a neutral into phase-to-phase waveforms allowing you to view the waveshape, angle relationships and harmonics of the phase-to-phase voltages.


Click on the  button on the waveform window toolbar. Click the button once again to return to phase-to-neutral waveforms.




## 7.4 Viewing Real-time Harmonic Spectrum

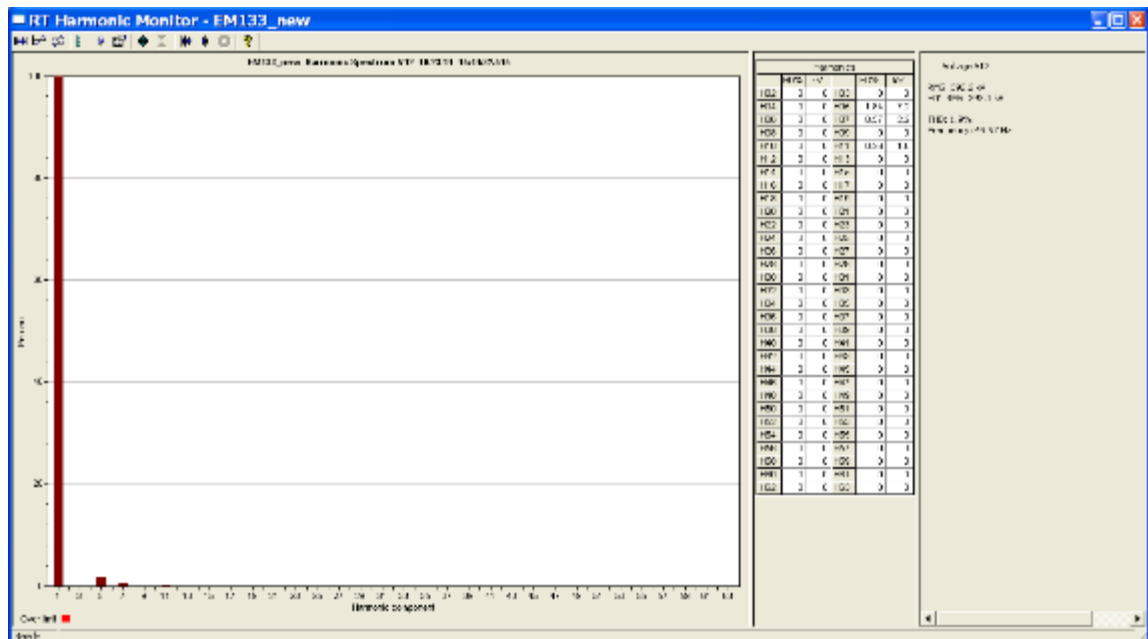
To retrieve real-time harmonic spectrum from your meter:

Ensure that the **On-line** button  on the PAS toolbar is checked.

Select the device site from the list box on the toolbar.

Select **RT Harmonic Monitor** from the Monitor menu or click on the  button on the PAS toolbar.


Click on the "Poll"  or "Continuous poll"  button to poll the meter once or continuously. Click on the **Stop** button  to stop continuous polling.



**Figure 7-3: RT Harmonic Monitor – Spectrum Chart**

PAS retrieves harmonic spectrum for V1-V3 and I1-I3 channels. Harmonics can be displayed as a spectrum chart for a selected channel or in a table. PAS can also synthesize waveforms based on the harmonic spectrum to let you view a shape of the voltage and current waveforms in your network.

### Viewing a Spectrum Chart

Click on the  button to view a spectrum chart for the selected channel. To change a channel, click on the window with the right mouse button, select **Channels...**, check the channel you want displayed, and then click **OK**. PAS provides voltage, current, active power and reactive power spectrum charts.

PAS can give you indication on whether harmonic levels in the sampled waveforms exceed compliance limits defined by the power quality standards or local regulations.

#### To review or change harmonic limits:

Click on the spectrum window with the right mouse button and select **Limits....**

Select a known harmonics standard, or select **Custom** and specify your own harmonic limits.

Check the **Enabled** box to visualize harmonic faults on the spectrum graph and in harmonic tables.

Harmonics that exceed selected compliance levels are colored in red on the graph and in the tables.

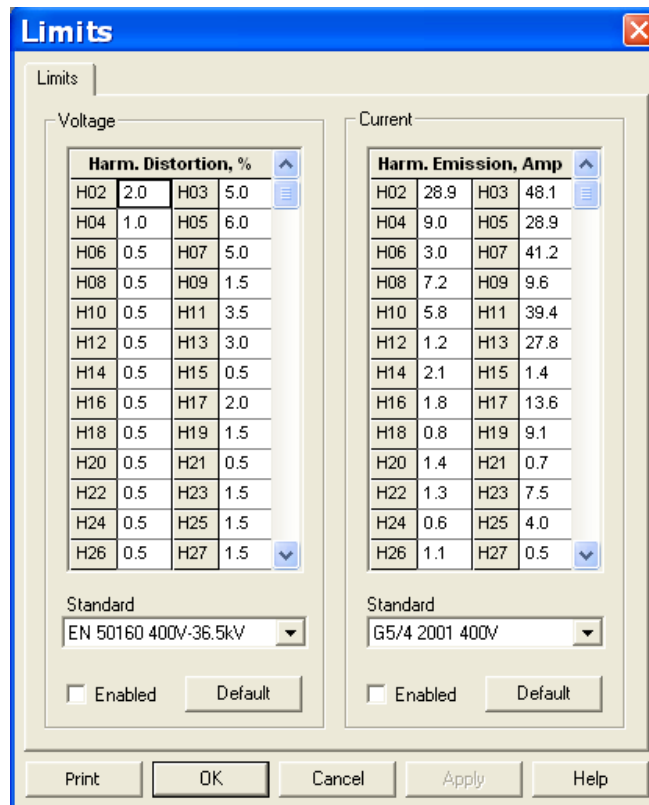



Figure 7-4: Harmonic Limits

### Viewing a Spectrum Table

Click on the  button on the local toolbar to display the harmonics spectrum in a tabular view for a selected phase or for all phases together.

The spectrum table shows voltage, current, active power and reactive power harmonic components both in percent of the fundamental and in natural units, and harmonic phase angles.

To change a phase, click on the window with the right mouse button, select **Options...**, check the phase you want displayed, and then click **OK**.



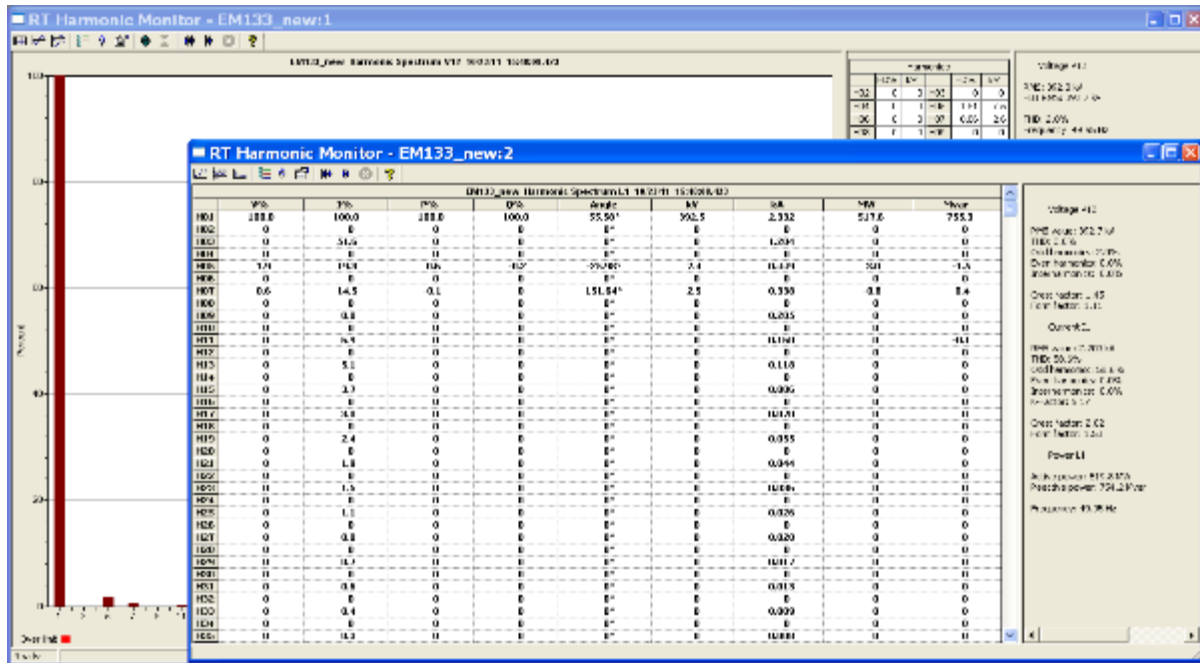




Figure 7-5: RT Harmonic Monitor – Spectrum Table

### Viewing Synthesized Waveforms

To view the synthesized waveforms based on the sampled harmonic spectrum, click on the  button on the local toolbar to view non-overlapped voltage and current waveforms, or click on the  button to view them overlapped.

PAS shows a pair of 4-cycle voltage and current synthesized AC waveforms for a single phase.

To select the channels you want to view, click with the right mouse button on the waveform window, select "Channels...", check the channels for the phase you want displayed, and then click OK.

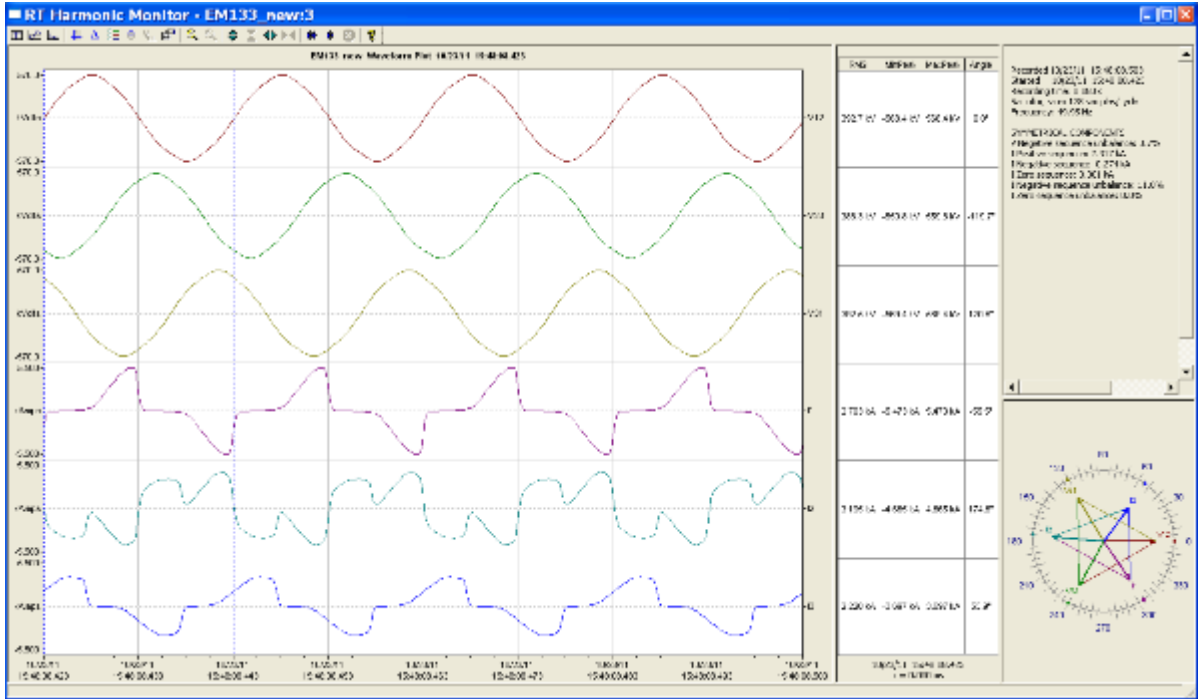


Figure 7-6: RT Harmonic Monitor – Synthesized Waveforms

# Chapter 8 Retrieving and Storing Files

PAS allows you to retrieve recorded events and data from your meters and to save them to files on your PC in the Microsoft Access database format.

Historical data can be uploaded on demand any time you need it, or periodically through the Upload Scheduler that retrieves data automatically on a predefined schedule, for example, daily, weekly or monthly.

If you do not change the destination database location, new data is added to the same database so you can store long-term data profiles in one database regardless of the upload schedule you selected.

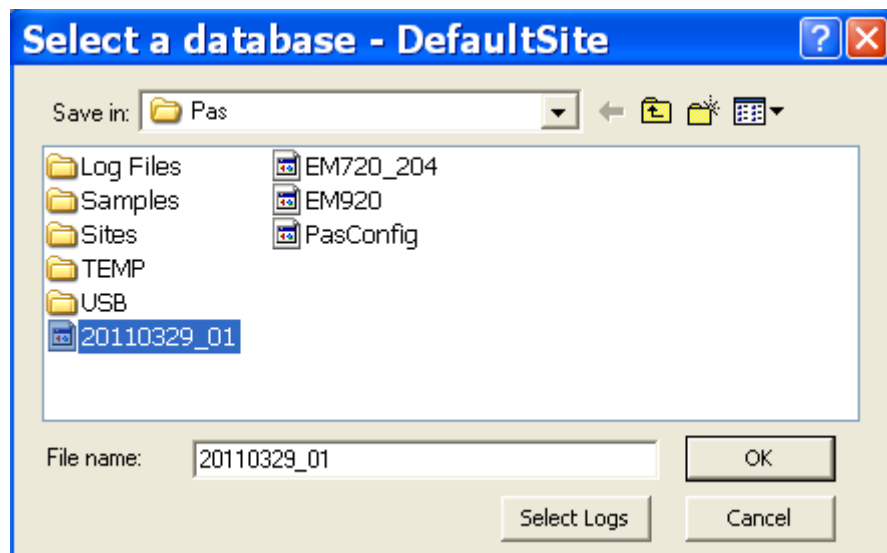
## 8.1 Uploading Files on Demand

To retrieve the log files from your meter:

Ensure that the On-line button  on the PAS toolbar is checked.

Select a device site from the list box on the PAS toolbar.

Select **Upload Logs** from the **Logs** menu.



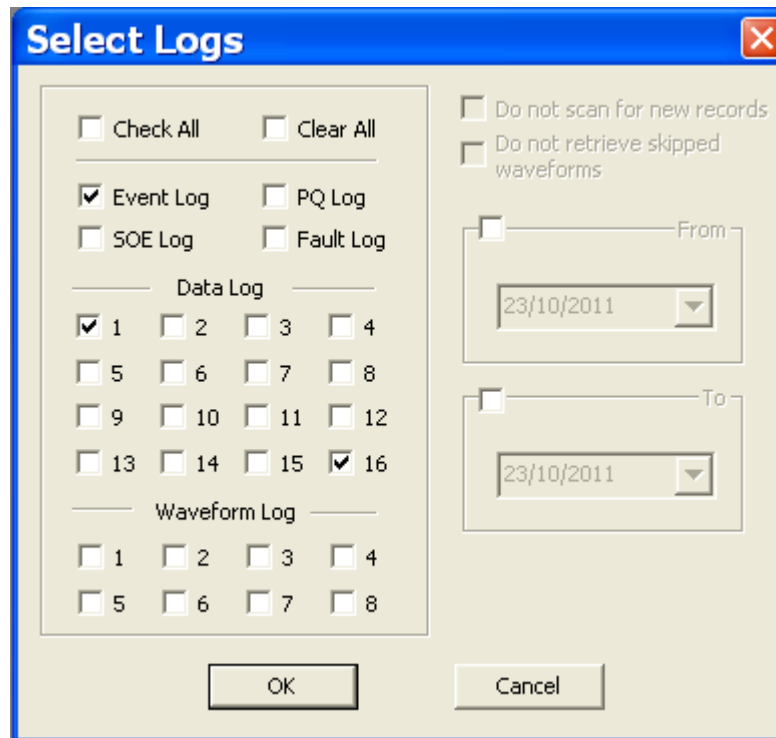
Select a database, or type the name for a new database, and select a directory where you want to save it.

Click on the **Select Logs** button and check boxes for logs you want to be retrieved from the meter.

If you wish to retrieve data starting with a known date, check the **"From"** box and select the start date for retrieving data.

If you wish to retrieve data recorded before a known date, check the **"To"** box and select the last date for retrieving data.

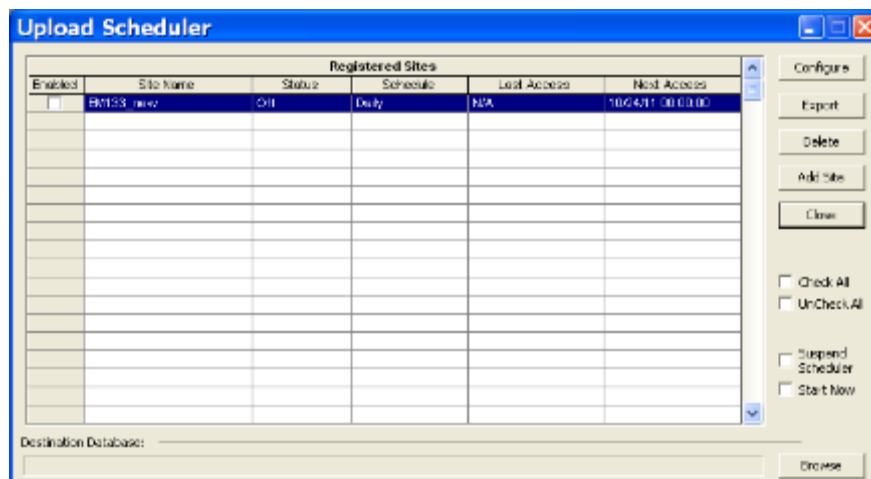
Click **OK**.



## 8.2 Using the Upload Scheduler

To setup the Upload Scheduler:

Select **Upload Scheduler** from the **Logs** menu.



**Figure 8-1: Upload Scheduler Setup Dialog Box**

Click **Add Site**, point to the site database for which you want to organize the schedule, and then click **OK**.

Click **Browse** and select a database for storing retrieved data, or type the name for a new database, select a directory where you want to save it, and then click **OK**.

Click **Configure** or double click on the site row.

Select a daily, weekly or monthly schedule, and adjust the start time. If you wish to upload data periodically in predefined intervals, click on **Periodic** and define the time period in hours and minutes.


Select the number of attempts to upload data in the event of temporary communication problems or unavailability of your device, and the delay between attempts in minutes and seconds.

If you wish to use the schedule to synchronize the device clock with your PC, check the **RTC Synchronization Enable** box. If your device is password protected by a communications password, type in the password you set in the device to allow PAS to update the clock.

Click on the **Select Logs** button, check the boxes for logs you want to upload on a schedule, and then click **OK**.

Check the **Enabled** box at left to activate a schedule for the device.

Click **Close** to store your schedule.

To keep the Upload Scheduler running, the On-line button  on the PAS toolbar must be checked all the time. If you uncheck it, the scheduler stops operations. This does not cause loss of data, since the scheduler will resume operations when you check this button again.

## **Suspending the Scheduler**

To suspend the Upload Scheduler, check the **Suspend Scheduler** box at right. To activate the Upload Scheduler, leave this box unchecked.

## **Running the Scheduler on Demand**





You can run the scheduler at any time outside the schedule by checking the **Start Now** box at right. This is a one-time action. After uploading is completed, the Upload Scheduler un-checks this box automatically.

## **Reviewing Upload Problems**

When the Upload Scheduler fails to retrieve data from the device, or some data is missing, or another problem occurs, it puts an error message to the log file. To review this file, select **System Log** from the **View** menu.

## 8.3 Viewing Files On-line

Sometimes, it is useful to review a particular piece of historical data on-line at the time you expect new events to appear in the log. PAS allows you to retrieve historical data from a particular log without storing it to a file. The data appears only in the window on your screen. You can save it manually to the database.

To view the log data on-line, check the **On-line** button  on the PAS toolbar, select the log you want to retrieve in the **Logs** menu, and then click on the **Poll** button . Only new log records are retrieved from the device. If you want to review the entire log from the beginning, click on the **Restore log** button , and then click on the **Poll** button .

NOTE

When reading multi-section profile data, only the first section is available for reading online.

See Chapter 9 [Viewing Files](#) for information on using different log views.


## 8.4 Exporting Files

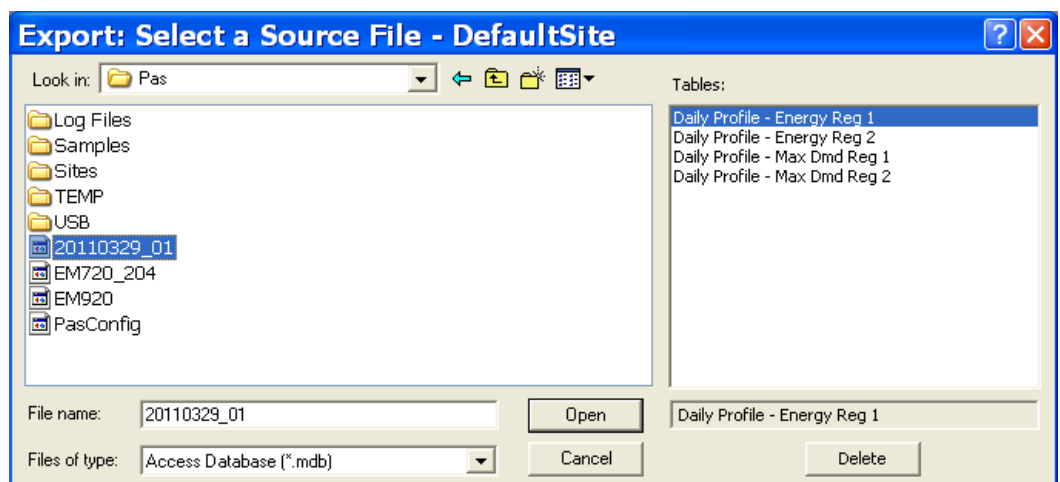
### Exporting Files in COMTRADE and PQDIF Formats

The COMTRADE and PQDIF file converters allow you to convert saved real-time waveforms into COMTRADE or PQDIF file format, and data log tables – into PQDIF format.

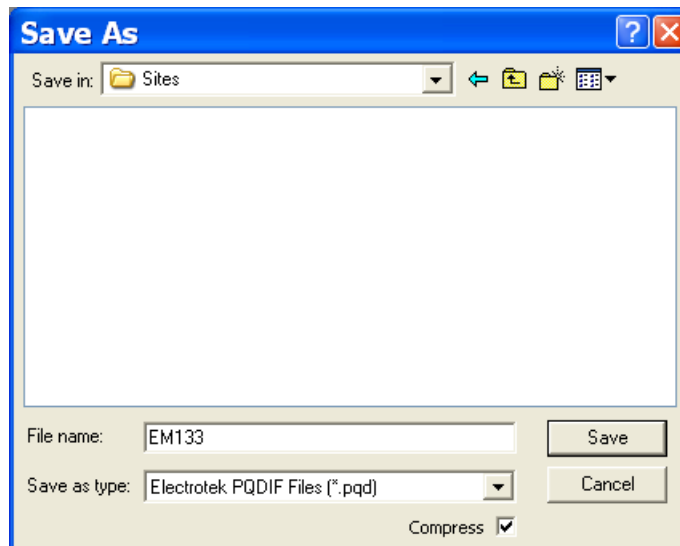
#### Manual Converting

To manually convert your waveforms or a data log into COMTRADE or PQDIF format:

Click on the Export  button on the PAS toolbar.



Select the database and a data log table you want to export, and then click Open.



Select a folder where you want to store your exported files, type a file name that identifies your files, select a file output format, and then click on the **Save** button.

The PQDIF files are commonly recorded in compressed format. If you do not want your files to be compressed, uncheck the **Compress** box before saving the file.

In COMTRADE format, each waveform event is recorded into a separate file.

PQDIF file names are followed by a timestamp of the first event recorded to the file, and may look like follows:

12KVSUB\_20040928T133038.pqd.

### **Automatic Converting**

PAS allows you to automatically convert data logs into PQDIF format at the time you upload data from your devices via the Upload Scheduler.

To automatically convert your data log tables into PQDIF format:

Open the Upload Scheduler.

Highlight a desired device site with the left mouse button, and then click on the **Export** button.

Check the **Enabled** box for a data log or a waveform log table you want to automatically convert at the upload time.

Highlight the **Record to...** row for the selected table and click on the **Browse** button.

Select a folder where you want to store converted files, type in the converted file's name, select a desired output file format, and then click on **Save**.

Repeat the same for all tables you wish to be converted.

Click **OK**.

### **Exporting Files in Excel Format**

PAS allows you to convert data tables into the Microsoft Excel workbook format, either manually, or automatically while retrieving data from your meters via the Upload Scheduler.

To store files in Excel format, follow instructions in the previous section and select **Excel Workbook** as the output file format.

The first row of the Excel table lists data names (see Appendix D) and the second row provides data codes, which identify recorded data points (see Modbus communications guide for data codes) that may be useful for automated table processing.

Each table row is provided with the device identifier that you can define in the meter database (see [Creating a New Site for your Meter](#)).

## 8.5 Archiving Files

Microsoft Access databases tend to grow fast. Databases above 0.5 Gigabytes can drastically slow down file operations.

To avoid enormous growing files, you can either periodically change the target database, or use the Upload Scheduler's file archiver to automatically move older data to archives.

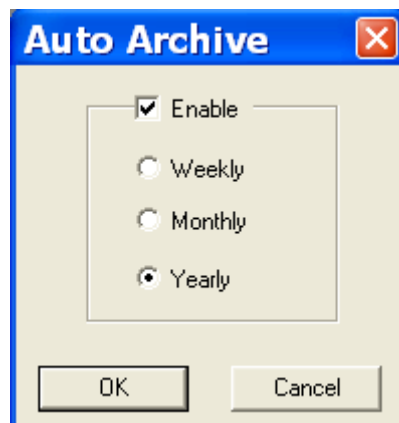
The Upload Scheduler archives files upon a weekly, monthly or yearly schedule. When archiving data, a new database is created to where older data from your present database with the expired archiving date is moved.

An archive file keeps the original database name to which the date of the oldest database record is added, so you can easily identify your archives and work with them as you work with a regular database.

To provide a schedule for archiving files:

When defining a schedule for uploading files from your meter, click on **Configure** or double click on the site row.

Click Auto Archive.



Check the **Enable** box and select a periodic schedule for archiving your files for this site.

Click **OK**.

To avoid archiving partially updated data, archiving is performed in a day after expiring a scheduled period and not before 2 hours a.m.




# Chapter 9 Viewing Files

## 9.1 Operations with Files

Files you read from the meters are stored in one or in a number of tables in the meter database. Sections of multi-section files like energy load profiles are stored in multiple tables – each file section in a separate database table.

### Opening a Database Table

To open a database table:

Click on the **Open** button  on the PAS toolbar, or select **Open...** from the File menu.


Select **Access Database (\*.mdb)** in the **Files of type** box; select a directory where your files are located, and point to the file you wish to open.

Select a desired table on the right pane, and then click **Open**, or double click on the table name.

Names of the last 16 files you opened are stored in the **File** menu, so you can select them directly from the menu.

### Saving Data to a File

To save data from the open database table to a file:

Click on the **Save** button , and select a directory where you want your file to be stored.

Select a database or type the name for a new database.

Click **Save**.

To avoid confusion, do not store data files into the **Sites** directory where site databases are located.

## 9.2 Viewing Options

### Customizing Views

#### Changing Date Order

To change the way PAS displays the date:

Select **Options** from the **Tools** menu and click on the **Preferences** tab.

Select the preferred date order.

Click **OK**.

#### Selecting Timestamp Format

The timestamp is normally recorded and displayed on the screen at a 1-ms resolution. If you have an application that does not support this format, you may instruct PAS to drop milliseconds.

To change the way PAS records and displays the timestamp:

Select **Options** from the **Tools** menu and click on the **Preferences** tab.

Select the preferred timestamp format.

Click **OK**.

## Working with Tables

### Selecting Font and Grid

To change the table font or a type of the grid lines:

Click with right mouse button on the table, select **Options** and click on the **Table** tab.

Select the font type and size and how you wish the table grid to be shown.

Click **OK**.

### Selecting Primary and Secondary Units


Voltages and currents can be displayed in primary or secondary units.

To change units, click on the table with the right mouse button, select **Options**, select the desired units for voltages and currents, and then click **OK**.


### Copying a Table

To copy the entire table, or its part, into the Clipboard or into another application such as Microsoft Excel or Word:

Click on the data window with the right mouse button and choose **Select All**, or click on the upper-left corner of the table (where the "No." label is commonly displayed).

Click with the right mouse button on the window again and choose **Copy**, or click on the **Copy** button  on the PAS toolbar.


Run the application to which you want to copy data, position the cursor at the correct place.

Click the **Paste** button  on the application's toolbar or select **Paste** from the **Edit** menu.

When copying, table columns are separated by a tab character.

### Printing a Table

To check how your document appears on a printed page, select **PrintPreview** from the **File** menu.

To print a table to a printer, click on the print button  on the toolbar, select a printer and click **OK**.

## Working with Graphic Windows

### Selecting Channels

To select the channels you want to view on the screen, click on the graph window with the right mouse button, select **Channels...**, check the channels you want displayed, and then click **OK**.

Checkboxes for channels that are not available in the present view are dimmed.

## Selecting Primary and Secondary Units

Voltages and currents can be displayed in primary or secondary units.

To change units, click on the table with the right mouse button, select **Options**, select the desired units for voltages and currents, and then click **OK**.

## Selecting the Time Axis

In waveform views, the horizontal axis can be displayed either in absolute time with date and time stamps, or in milliseconds relatively to the beginning of a waveform.

To change the time units, click on the waveform window with the right mouse button, select **Options...**, click on the **Axes** tab, select the desired units, and then click **OK**.

## Selecting Line Styles and Colors

Channel waveforms can be displayed using different colors and line styles.

To change the colors or line styles, click on the graph window with the right mouse button, select **Options...**, click on the **Display** tab, adjust colors and styles, and then click **OK**.

## Selecting Grid and Frame Colors

Click on the graph window with the right mouse button, select **Options...**, and click on the **Display** tab


To change the color or style of the grid lines, click on the **Grid** line on the left pane, and then select the color and style for the grid. To disable the grid, uncheck the **Grid Visible** box.

To change the window frame color to white, check the **White Frame** box at right.

## Using Marker Lines


The waveform and trend windows have two blue dashed marker lines. The left marker indicates the starting position and the right marker indicates the end position for calculating the average and peak values.

The minimum distance between the two markers is exactly one cycle.

To change the marker position, click on the  button, or click on the window with the right mouse button and select **Set Marker**, and then click on the point where you want to put the marker.

You can also drag both markers with the mouse, or use the right and left arrow keys on your keyboard to change the marker position. Click on the graph pane to allow the keyboard to get your input before using the keyboard.

## Delta Measurements



To measure the distance between two waveform or trend points, click on the **Delta** button , then click on the first point, and then click on the second point.

The first reference point is still frozen until you uncheck and check the **Delta** button again, while the second point can be placed anywhere within the graph line by clicking on the graph to the left or right from the reference point.

To disable delta measurements, click on the **Delta** button once again.

### Using a Zoom

You can use a horizontal and, for waveforms, also a vertical, zoom to change size of your graph.


Use the  buttons on your local toolbar to zoom in and zoom out. One click gives you a 100-percent horizontal or 50-percent vertical zoom. Two buttons  representing magnifying glasses give you a proportional zoom in both directions.

### Copying a Graph

To copy a graph, or its part, into the Clipboard or into another application such as Microsoft Excel or Word:


Click on the graph window with the right mouse button and choose **Copy All**, or **Copy Waveform**. Some windows may have additional options.

Position the cursor at the place where you wish to copy the graph.

Click the **Paste** button  on the application's toolbar or select Paste from the **Edit** menu.

### Printing a Graph

To check how the graph appears on a printed page, select **Print Preview** from the **File** menu.

To print a graph to a printer, click on the **Print** button  on the PAS toolbar, select a printer and click **OK**.

## 9.3 Viewing the Event Log

The Event log contains time-tagged events related to configuration changes, resets and device diagnostics.

The Event log is displayed in a tabular view, one event per row. Use the scroll bar to view the entire log contents.


No.	Date/Time	Event	Cause	Point/Source	Value	Effect	Target
141	10/23/11 11:10:48.489	EXTERNAL	Power down				
142	10/23/11 11:11:36.000	EXTERNAL	Power up				
143	10/23/11 11:25:58.829	EXTERNAL	Power down				
144	10/23/11 11:28:35.000	EXTERNAL	Power up				
145	10/23/11 11:38:50.716	EXTERNAL	Power down				
146	10/23/11 11:38:53.000	EXTERNAL	Power up				
147	10/23/11 11:50:21.121	EXTERNAL	Power down				
148	10/23/11 11:51:31.000	EXTERNAL	Power up				
149	10/23/11 11:55:14.281	COMM	Basic setup			Setup change	
150	10/23/11 11:55:20.199	COMM	Basic setup			Setup change	
151	10/23/11 12:42:39.715	EXTERNAL	Power down				
152	10/23/11 12:42:46.000	EXTERNAL	Power up				
153	10/23/11 12:42:55.581	EXTERNAL	Power down				
154	10/23/11 12:43:13.000	EXTERNAL	Power up				
155	10/23/11 12:44:37.837	EXTERNAL	Power down				
156	10/23/11 12:44:40.000	EXTERNAL	Power up				
157	10/23/11 12:44:42.733	EXTERNAL	Power down				
158	10/23/11 12:46:58.000	EXTERNAL	Power up				
159	10/23/11 14:56:58.794	EXTERNAL	Power down				
160	10/23/11 14:57:01.000	EXTERNAL	Power up				
161	10/23/11 14:57:04.970	EXTERNAL	Power down				
162	10/23/11 14:57:08.000	EXTERNAL	Power up				
163	10/23/11 14:57:10.303	EXTERNAL	Power down				
164	10/23/11 14:57:12.000	EXTERNAL	Power up				
165	10/23/11 15:01:30.265	EXTERNAL	Power down				
166	10/23/11 15:01:32.000	EXTERNAL	Power up				
167	10/23/11 15:01:37.880	EXTERNAL	Power down				
168	10/23/11 15:01:40.000	EXTERNAL	Power up				
169	10/23/11 15:01:48.601	EXTERNAL	Power down				
170	10/23/11 15:01:51.000	EXTERNAL	Power up				
171	10/23/11 15:03:55.131	COMM	Basic setup			Setup change	
172	10/23/11 15:04:50.331	COMM	Basic setup			Setup change	
173	10/23/11 15:16:49.456	COMM	Setpoints setup			Setpoint set	#1
174	10/23/11 15:18:17.116	COMM	Counters setup			Setup change	
175	10/23/11 15:23:09.243	COMM	Setpoints setup			Setpoint set	#1
176	10/23/11 15:23:07.496	COMM	Setpoints setup			Setpoint set	#1
177	10/23/11 15:45:29.433	COMM	Counters setup			Setup change	
178	10/23/11 15:45:36.765	COMM	Counters setup			Setup change	
179	10/23/11 15:52:43.369	EXTERNAL	Power down				
180	10/23/11 15:52:46.000	EXTERNAL	Power up				


Figure 9-1: Event Log Window

See [Working with Tables](#) for more information on viewing options.

### Filtering and Sorting Events

You can use filtering to find and work with a subset of events that meet the criteria you specify.

Click on the Filter button , or click on the report window with the right mouse button and select **Filter...** Check the causes of events you want to display, and then click **OK**. PAS temporarily hides rows you do not want displayed.

To change the default sorting order based on the date and time, click on the **Sort** button , or click on the report window with the right mouse button and select **Sort...**, check the desired sort order, and then click **OK**.

## 9.4 Viewing the Data Log

Data log files can be displayed in a tabular view, one data record per row, or in a graphical view as a data trend graph.

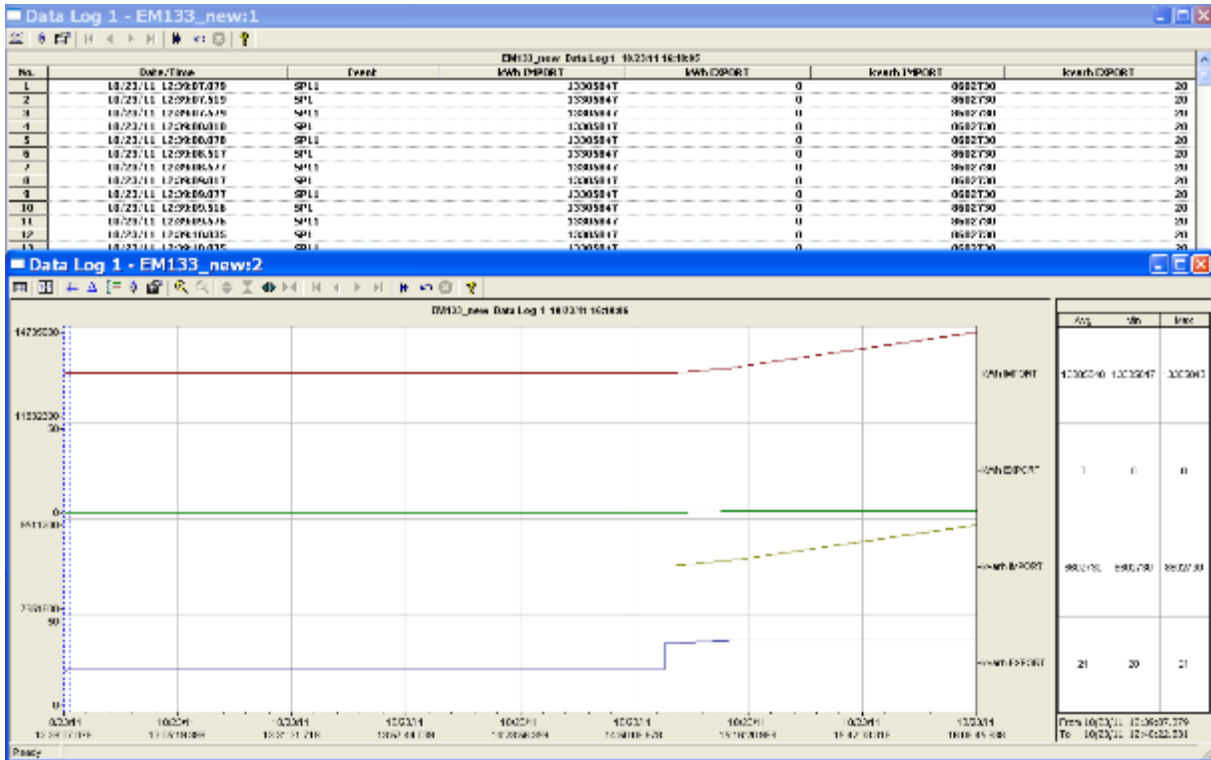




Figure 9-2: Data Log Window

### Viewing Data Trend

To view data in a graphical form, click on the **Data Trend**  button on the local toolbar.

To change the time range for your graph, click on the **Time Range**  button on the local toolbar, and then select the desired date and time range.

# Appendix A Technical Specifications

## A.1 Environmental Conditions

Operational ambient temperature limit range: -25°C to +60°C

Specified ambient temperature range: -20°C to +60°C

Long-term damp heat withstand according to IEC 68-2-3 <95% (non-condensing), +40 °C

Transport and storage temperature range: -30°C to +85 °C

### **IEC 60068-2-6, AS 60068-2-6 [18]: Vibration**

Frequency range: 10Hz to 150Hz

Vibration time (each axis): 75 min

Sweep rate: 1 oct/min

Max Vibration level: 10 m/s<sup>2</sup> (1g), f > 60Hz

### **IEC 60068-2-27, AS 60068-2-27 [19]: Shock**

Shock level: 30 g

Time duration: 18 ms

Shape: Half sine

Number of shocks: 18

## A.2 Construction

Case enclosure: Reinforced Polycarbonate

Packaging case: Carton and Stratocell® (Polyethylene Foam) brackets

Labels: Polyester film (UL94-V0)

## A.3 Three Phase Power Supply – EM133-SE (Y & Δ)

Indirect Connection or Direct Connection using HACCS

Rated input from 1, 2 or 3 phases: 3 x 120/207-277/480 VAC 50/60Hz  
Burden 2VA per phase

Direct Connection

Rated input from 1, 2 or 3 phases: 3 x 120/207-230/400 VAC 50/60Hz  
Burden 2VA per phase

Isolation:

Input to ground: 4000V AC

## A.4 Auxiliary Power Supply – EM132-133

Rated input: 40-300VAC 50/60Hz, 40-300VDC, Burden 5VA

Frequency range operation 25-400 Hz

Isolation:

Input to ground: 4000V AC

## A.5 Input Ratings

### **Voltage Inputs – Installation category III**

#### **Model with 3 Phase Power Supply – EM133-SE (Y & Δ)**

Operating range: 120/207V to 277/480VAC for 1A/5A/RS5 models

Operating range: 120/207V to 230/400VAC for HACS models

Frequency range measurement 50-60 Hz

Burden for 277V: < 1.5 VA

Burden for 120V: < 2 VA

#### **Model with Aux. Power Supply – EM132-133**

Operating range: up to 400/690 VAC

Measurement range: direct input and input via PT up to 828VAC line-to-line, up to 480VAC line-to-neutral

Frequency range measurement 25-400 Hz

Burden for 400V: < 0.4 VA

Burden for 120V: < 0.04 VA

Over-voltage withstands: 1000 VAC continuous, 2000 VAC for 1 second

Input impedance: 1000 kΩ

### **Current Inputs (via CT) – Installation category III**

Galvanic isolation: 4000V AC

#### **5A secondary (standard)**

Current rating: 5A RMS

Maximum continuous current: 10A RMS

Frequency range measurement 25-400 Hz

Burden: < 0.2 VA @ In=5A

Overload withstanding:

15A RMS continuous, 300A RMS for 1 second

#### **1A secondary (1A option)**

Current rating: 1A RMS

Maximum continuous current: 2A RMS

Frequency range measurement 25-400 Hz

Burden: < 0.02 VA @ In=1A

Overload withstanding:

3A RMS continuous, 80A RMS for 1 second

#### **50A direct (100A option)**

Current rating: 50A RMS

Maximum continuous current: 100A RMS @ 55°C ambient temperature

Maximum continuous current: 60A RMS @ 60°C ambient temperature

Frequency range measurement 25-400 Hz up to 50A

Burden: < 0.02 VA @ In=50A

Overload withstanding:



100A RMS continuous @ 55°C, 2500A RMS for 1 second

**40mA secondary – with HACS** (external CT option)

External CT Operating range: continuous 100-1200A RMS

Frequency range measurement 50-60 Hz

**5mA secondary – with external CT** (RS5 option)

Operating range: continuous 10A RMS

Frequency range measurement 50-60 Hz

Burden: < 0.2 VA @ In=5A

Overload withstanding:

15A RMS continuous, 300A RMS for 1 second

**Sampling Rate measurement**

128 samples per cycle

## A.6 Relay Outputs

**Solid State relay standard**

1 relay rated at 0.15A/24V AC/DC, 1 contact (SPST Form A)

Galvanic isolation: 4000V AC 1 min

Operate time: 1 ms max.

Release time: 0.25 ms max.

Update time: 1 cycle

**Electromechanical relay - DRY contact, option** (4DI/2DO and 12DI/4DO Optional modules)

2 or 4 relays rated at 5A/250V AC; 5A/30V DC, 1 contact (SPST Form A)

Galvanic isolation:

Between contacts and coil: 3000V AC 1 min

Between open contacts: 750V AC

Operate time: 10 ms max.

Release time: 5 ms max.

Update time: 1 cycle

**Solid State relay option** (4DI/2DO Optional module)

2 relays rated at 0.15A/250V AC/DC, 1 contact (SPST Form A)

Galvanic isolation: 3750V AC 1 min

Operate time: 1 ms max.

Release time: 0.25 ms max.

Update time: 1 cycle

Connector type: removable, 4 pins.

## A.7 Digital Inputs

**Digital Input (standard)**

1 Digital Inputs Dry Contacts, internally wetted @ 5VDC

Sensitivity: Open @ input resistance >100 k $\Omega$ , Closed @ Input resistance < 100  $\Omega$

Galvanic isolation: 4000V AC 1 min

Internal power supply: 5VDC

Scan time: 1 ms

**Digital Input (option)**

**4 Digital Inputs Dry Contacts, internally wetted @ 24VDC** (4DI/2DO Optional module)

Sensitivity: Open @ input resistance >100 k $\Omega$ , Closed @ Input resistance < 100  $\Omega$

Galvanic isolation: 3750V AC 1 min

Internal power supply: 24V DC

Scan time: 1 ms

Connector type: removable, 5 pins.

**8 Digital Inputs Dry Contacts, internally wetted @ 24VDC** (8DI Optional module)

Sensitivity: Open @ input resistance >100 k $\Omega$ , Closed @ Input resistance < 100  $\Omega$

Galvanic isolation: 3750V AC 1 min

Internal power supply: 24V DC

Scan time: 1 ms

Connectors type: removable, 4 and 5 pins

**12 Digital Inputs Dry Contacts** (12DI/4DO Optional module)

Galvanic isolation: 2500V AC 1 min

Scan time: 1 ms

Connector type: removable, 5 pins.

**Internally/externally wetted @ 24VDC** - option 1/2:

Wet contact sensing: Open > 16k $\Omega$ , Closed < 10k $\Omega$

**Externally wetted @ 120VDC** - option 3:

Wet contact sensing option 1: Open > 160k $\Omega$ , Closed <60k $\Omega$

**Externally wetted @ 220VDC** - option 4:

Wet contact sensing option 1: Open >320k $\Omega$ , Closed <100k $\Omega$

## A.8 Optional Analog Outputs

4 Analog Outputs optically isolated (AO Optional module)

Ranges (upon order):

$\pm$ 1 mA, maximum load 5 k $\Omega$  (100% overload)

0-20 mA, maximum load 510  $\Omega$

4-20 mA, maximum load 510  $\Omega$

0-1 mA, maximum load 5 k  $\Omega$  (100% overload)

Isolation: 2500V AC 1 min

Power supply: internal

Accuracy: 0.5% FS

Update time: 1 cycle

Connector type: removable, 5 pins.

## A.9 Communication Ports

### **COM1** (standard)

RS-485 optically isolated port

Isolation: 3000V AC 1 min

Baud rate: up to 115.2 kbps.

Protocols: Modbus RTU, DNP3, SATEC ASCII and IEC 60870-5-101

Connector type: removable, 3 pins

### **COM2 option**

#### **Ethernet Port(Optional module)**

Transformer-isolated 10/100BaseT Ethernet port

Protocols: MODBUS/TCP (Port 502), DNP3/TCP (Port 20000),

IEC 60870-5-104

Number of simultaneous connections: 4 (2 MODBUS/TCP + 2 DNP3/TCP).

Connector type: RJ45 modular.

#### **PROFIBUS DP (IEC 61158)** (Optional module)

RS-485 optically isolated PROFIBUS interface.

Connector type: removable, 5 pins.

Baud rate: 9600 bit/s – 12 Mb/s (auto detection).

32 bytes input, 32 bytes output.

Protocols: PROFIBUS

#### **CANopen** (Optional module)

RS-485 optically isolated CANopen interface.

Connector type: removable, 5 pins.

Protocols: CANopen

#### **RS-232/422-485 Port** (Optional module)

RS-232 or RS-422/485 optically isolated port

Isolation: 3000V AC 1 min

Baud rate: up to 115.2 kbps.

Protocols: MODBUS RTU, DNP3, and SATEC ASCII

Connector type: removable, 5 pins for RS-422/485 and DB9 for RS-232.

### **COM3** (standard)

Infra-Red COM port

Baud rate: up to 38.4 kbps.

Protocols: MODBUS RTU

## A.10 Real-time Clock

Standard Meter Clock

Crystal Clock Accuracy: typical error 13.15 sec per month (2.63 minutes per year) @ 25°C (±5ppm)

Typical clock retention time: 15 months

**TOU Module** Meter Clock (option)

Accuracy: typical error 7 seconds per month @ 25°C ( $\pm 2.5$ ppm)

Typical clock retention time: 36 months

## Appendix B Standards Compliance

Per EN50470-1-3, IEC 62052-11, NMI M6-1 and ANSI C12.1

UL916 E472110

### **Accuracy:**

EN50470-3, class C

IEC/AZ 62053-22, class 0.5S – active energy

IEC 62053-21, class 0.5 – reactive energy

IEC 60688, class 0.5S – active energy

IEC 60688, class 1 – reactive energy

ANSI C12.20, class 100 (HACS), accuracy class 0.5

### **Electromagnetic Immunity according to IEC 62052-11 and EN50470-1/3:**

IEC61000-4-2: Electrostatic discharge, 15/8 kV air/contact

IEC61000-4-3: Electromagnetic RF Fields, 10V/m @ 80 MHz – 1000MHz

IEC61000-4-4: Fast Transients burst, 4KV on current and voltage circuits and 2 KV for auxiliary circuits

IEC61000-4-5: Surge 4KV on current and voltage circuits and 1 KV for auxiliary circuits

IEC61000-4-6: Conducted Radio-frequency, 10V @ 0.15 MHz – 80MHz

IEC61000-4-8: Power Frequency Magnetic Field

IEC61000-4-12: Oscillatory waves

### **Electromagnetic Emission:**

Comply with IEC CISPR 22:

Radiated Class B

Conducted class A

Conducted class B (with SATEC RF choke)

### **Safety/Construction:**

EN/IEC 62052-11: 4000V AC @ 1 minute, 6KV/500Ω @ 1.2/50 μs impulse

NMI M6-1 (EM133-SE only): 4000V AC @ 1 minute, 12KV/40Ω @ 1.2/50 μs impulse

UL916, UL1059

## Measurement Specifications

Table 23: Measurement Specifications Parameters

Parameter	Full Scale @ Input Range	Accuracy			Range
		% Reading	% FS	Conditions	
Voltage, V	120VxPT @ 120V 400VxPT @ 690V	0.2 0.2	0.02 0.02	10% to 120% 10% to 115%	0 to 1,150,000 V Starting voltage 1.5-5.0% FS (selectable)
Voltage, V (EM133-SE model)	V <sub>L</sub> = 120V, V <sub>L</sub> = 230V	0.2 0.2	0.02 0.02	10% to 120% 10% to 115%	80 to 1,150,000 V Starting voltage 80VAC (w/1phase)
Line current, A	CT	0.2	0.02	For In = 5A 1% to 200% FS For In = 1A 2% to 200% FS	Starting current 0.1% FS
Line current - direct	50 A	0.2	0.02	2% to 200% FS	Starting current 0.1% FS
Active power, kW	0.36xPTxCT @ 120V 1.2xPTxCT @ 690V 34.5 @ (230V,50A)	0.3	0.02	PF  ≥ 0.5 <sup>1</sup>	-10,000,000 kW to +10,000,000 kW
Reactive power, kvar	0.36xPTxCT @ 120V 1.2xPTxCT @ 690V 34.5 @ (230V,50A)	0.3	0.03	PF  ≤ 0.9 <sup>1</sup>	-10,000,000 kvar to +10,000,000 kvar
Apparent power, kVA	0.36xPTxCT @ 120V 1.2xPTxCT @ 690V 34.5 @ (230V,50A)	0.3	0.02	PF  ≥ 0.5 <sup>1</sup>	0 to 10,000,000 kVA
Power factor	1.000		0.2	PF  ≥ 0.5, I ≥ 2% FSI	-0.999 to +1.000
Frequency	50 Hz 60 Hz 25 Hz 400 Hz	0.02 0.02 0.04 0.04		V <sub>L-N</sub> > 25V	15 Hz to 70 Hz 15 Hz to 70 Hz 15 Hz to 70 Hz 320 Hz to 480 Hz
Total Harmonic Distortion, THD V(I), %V <sub>f</sub> (%I <sub>f</sub> )	999.9	1.5	0.2	THD ≥ 1%, V ≥ 10% FSV and V <sub>L-N</sub> > 25V, I ≥ 10% FSI	0 to 999.9
Total Demand Distortion, TDD, %	100		1.5	TDD ≥ 1%, I ≥ 10% FSI, V <sub>L-N</sub> > 25V	0 to 100
Active energy Import & Export	In = 5 and 1 A	Class C as per EN50470-3, Class 0.5S under conditions as per IEC/AZ 62053-22:2003 at 50/60 Hz & ANSI C12.20 Ac. Class 0.5			0 to 999,999,999 kWh
Reactive energy Import & Export	In = 5 and 1 A	Class 0.5S under conditions as per IEC 62053-22:2003,  PF  ≤ 0.9 and at 50/60 Hz			0 to 999,999,999 kvarh
Apparent energy	In = 5 and 1 A	Class 0.5S under conditions as per IEC 62053-22:2003 at 50/60 Hz			0 to 999,999,999 kVAh

PT - external potential transformer ratio

CT - primary current rating of the external current transformer

FSV - voltage full scale

FSI - current full scale

V<sub>f</sub> - fundamental voltageI<sub>f</sub> - fundamental current

<sup>1</sup> @ 80% to 120% of voltage FS, 1% to 200% of current FS at (In = 5 and 1 A), 2% to 200% of current FS 50 A and frequency 50/60 Hz

NOTES:

- Accuracy is expressed as  $\pm$  (percentage of reading + percentage of full scale)  $\pm$  1 digit. This does not include inaccuracies introduced by the user's potential and current transformers. Accuracy calculated at 1second average.
- Specifications assume: voltage and current waveforms with THD  $\leq$  5% for kvar, kVA and PF, and reference operating temperature 20°C - 26°C.
- Measurement error is typically less than the maximum error indicated.

# Appendix C Analog Output Parameters

The following table lists parameters that can be provided on the meter's analog outputs.

**Table 24: Analog Output Parameters**

Designation	Description
NONE	None (output disabled)
	<b>1-Cycle Phase Values</b>
V1/12 RT <sup>1</sup>	V1/V12 Voltage
V2/23 RT <sup>1</sup>	V2/V23 Voltage
V3/31 RT <sup>1</sup>	V3/V31 Voltage
V12 RT	V12 Voltage
V23 RT	V23 Voltage
V31 RT	V31 Voltage
I1 RT	I1 Current
I2 RT	I2 Current
I3 RT	I3 Current
	<b>1-Cycle Total Values</b>
kW RT	Total kW
kvar RT	Total kvar
kVA RT	Total kVA
PF RT	Total PF
PF LAG RT	Total PF Lag
PF LEAD RT	Total PF Lead
	<b>1-Cycle Auxiliary Values</b>
In RT	In Current
FREQ RT	Frequency
	<b>1-Sec Phase Values</b>
V1/12 AVR <sup>1</sup>	V1/V12 Voltage
V2/23 AVR <sup>1</sup>	V2/V23 Voltage
V3/31 AVR <sup>1</sup>	V3/V31 Voltage
V12 AVR	V12 Voltage
V23 AVR	V23 Voltage
V31 AVR	V31 Voltage
I1 AVR	I1 Current
I2 AVR	I2 Current
I3 AVR	I3 Current
	<b>1-Sec Total Values</b>
kW AVR	Total kW
kvar AVR	Total kvar
kVA AVR	Total kVA
PF AVR	Total PF
PF LAG AVR	Total PF Lag
PF LEAD AVR	Total PF Lead
	<b>1-Sec Auxiliary Values</b>
In AVR	In Current
FREQ AVR	Frequency



<b>Designation</b>	<b>Description</b>
	<b>Demands E, EH</b>
kW IMP ACD	Accumulated kW import demand
kW EXP ACD	Accumulated kW export demand
kvar IMP ACD	Accumulated kvar import demand
kvar EXP ACD	Accumulated kvar export demand
kVA ACD	Accumulated kVA demand

<sup>1</sup>In 4LN3, 3LN3 and 3BLN3 wiring modes, the voltages will be line-to-neutral; for any other wiring mode, they will be line-to-line voltages.

## Appendix D Setpoint Triggers and Actions

Table 25: Setpoint Triggers

Designation	Description
NONE	None (condition is not active)
	<b>Status Inputs</b>
STAT INP #1 ON	Status input #1 ON
STAT INP #2 ON	Status input #2 ON
STAT INP #3 ON	Status input #3 ON
STAT INP #4 ON	Status input #4 ON
STAT INP #5 ON	Status input #5 ON
STAT INP #6 ON	Status input #6 ON
STAT INP #1 OFF	Status input #1 OFF
STAT INP #2 OFF	Status input #2 OFF
STAT INP #3 OFF	Status input #3 OFF
STAT INP #4 OFF	Status input #4 OFF
STAT INP #5 OFF	Status input #5 OFF
STAT INP #6 OFF	Status input #6 OFF
	<b>Relays</b>
RELAY #1 ON	Relay #1 ON
RELAY #2 ON	Relay #2 ON
RELAY #3 ON	Relay #3 ON
RELAY #1 OFF	Relay #1 OFF
RELAY #2 OFF	Relay #2 OFF
RELAY #3 OFF	Relay #3 OFF
	<b>Phase Reversal</b>
POS PHASE REVERSAL	Positive phase rotation reversal
NEG PHASE REVERSAL	Negative phase rotation reversal
	<b>Low/High 1-Cycle Values on any Phase</b>
HI VOLT RT <sup>1</sup>	High voltage
LO VOLT RT <sup>1</sup>	Low voltage
HI AMPS RT	High current
LO AMPS RT	Low current
HI V THD <sup>2</sup>	High voltage THD
HI I THD <sup>2</sup>	High current THD
HI KF RT	High K-Factor
HI I TDD	High current TDD
	<b>1-Cycle Auxiliary Values</b>
HI FREQ RT	High frequency
LO FREQ RT	Low frequency
HI V UNB% RT <sup>1</sup>	High voltage unbalance
HI I UNB% RT	High current unbalance
	<b>1-Sec Phase Values</b>
HI I1 AVR	High I1 current
HI I2 AVR	High I2 current
HI I3 AVR	High I3 current
LO I1 AVR	Low I1 current
LO I2 AVR	Low I2 current

<b>Designation</b>	<b>Description</b>
LO I3 AVR	Low I3 current
	<b>1-Sec Values on any Phase</b>
HI VOLT AVR <sup>1</sup>	High voltage
LO VOLT AVR <sup>1</sup>	Low voltage
HI AMPS AVR	High current
LO AMPS AVR	Low current
	<b>1-Sec Total Values</b>
HI kW IMP AVR	High total kW import
HI kW EXP AVR	High total kW export
HI kvar IMP AVR	High total kvar import
HI kvar EXP AVR	High total kvar export
HI kVA AVR	High total kVA
HI PF LAG AVR	Low total PF Lag
HI PF LEAD AVR	Low total PF Lead
	<b>1-Sec Auxiliary Values</b>
HI In AVR	High neutral current
HI FREQ RT	High frequency
LO FREQ RT	Low frequency
	<b>Demands</b>
HI V1/12 DMD <sup>1</sup>	High V1/V12 Volt demand
HI V2/23 DMD <sup>1</sup>	High V2/V23 Volt demand
HI V3/31 DMD <sup>1</sup>	High V3/V31 Volt demand
HI I1 DMD	High I1 Ampere demand
HI I2 DMD	High I2 Ampere demand
HI I3 DMD	High I3 Ampere demand
HI kW IMP BD	High block kW import demand
HI kvar IMP BD	High block kvar import demand
HI kVA BD	High block kVA demand
HI kW IMP SD	High sliding window kW import demand
HI kvar IMPSD	High sliding window kvar import demand
HI kVA SD	High sliding window kVA demand
HI kW IMP ACD	High accumulated kW import demand
HI kvar IMP ACD	High accumulated kvar import demand
HI kVA ACD	High accumulated kVA demand
HI kW IMP PRD	High predicted kW import demand
HI kvar IMP PRD	High predicted kvar import demand
HI kVA PRD	High predicted kVA demand
	<b>Time and Date Parameters</b>
DAY OF WEEK	Day of week
YEAR	Year
MONTH	Month
DAY OF MONTH	Day of month
HOURS	Hours
MINUTES	Minutes
SECONDS	Seconds
MINUTE INTERVAL	Minute interval: 1-5, 10, 15, 20, 30, 60 min

<sup>1</sup>In 4LN3, 3LN3 and 3BLN3 wiring modes, the voltages will be line-to-neutral; for any other wiring mode, they will be line-to-line voltages.

**Table 26: Setpoint Actions**

<b>Designation</b>	<b>Description</b>
NONE	None (no action)
OPERATE RELAY #1	Operate relay RO1
OPERATE RELAY #2	Operate relay RO2
OPERATE RELAY #3	Operate relay RO3
RELEASE RELAY #1	Release latched relay RO1
RELEASE RELAY #2	Release latched relay RO2
RELEASE RELAY #3	Release latched relay RO3
INC CNT #1	Increment counter #1
INC CNT #2	Increment counter #2
INC CNT #3	Increment counter #3
INC CNT #4	Increment counter #4
TIME CNT #1	Count operation time using counter #1
TIME CNT #2	Count operation time using counter #2
TIME CNT #3	Count operation time using counter #3
TIME CNT #4	Count operation time using counter #4
NOTIFICATION	Send a notification message
DATA LOG #1	Record data to Data Log #1

## Appendix E Parameters for Data Monitoring and Logging

The following table lists parameters measured by the meter that are available for monitoring through communications and for recording to a data log file. The left column shows data abbreviations used in PAS. Parameter groups are highlighted in bold.

**Table 27: Data Monitoring and Logging Parameters**

<b>Designation</b>	<b>Description</b>
NONE	None (stub, read as zero)
<b>DIGITAL INPUTS</b>	<b>Digital Inputs</b>
DI1:16	Digital Inputs Status DI1:DI6
<b>RELAYS</b>	<b>Relays</b>
RO1:16	Relay Status RO1:RO3
<b>COUNTERS</b>	<b>Pulse Counters</b>
COUNTER 1	Counter #1
COUNTER 2	Counter #2
COUNTER 3	Counter #3
COUNTER 4	Counter #4
<b>RT PHASE</b>	<b>1-Cycle Phase Values</b>
V1	V1/V12 Voltage <sup>1</sup>
V2	V2/V23 Voltage <sup>1</sup>
V3	V3/V31 Voltage <sup>1</sup>
I1	I1 Current
I2	I2 Current
I3	I3 Current
kW L1	kW L1
kW L2	kW L2
kW L3	kW L3
kvar L1	kvar L1
kvar L2	kvar L2
kvar L3	kvar L3
kVA L1	kVA L1
kVA L2	kVA L2
kVA L3	kVA L3
PF L1	Power factor L1
PF L2	Power factor L2
PF L3	Power factor L3
V1 THD	V1/V12 Voltage THD <sup>1</sup>
V2 THD	V2/V23 Voltage THD <sup>1</sup>
V3 THD	V3/V31 Voltage THD <sup>1</sup>
I1 THD	I1 Current THD
I2 THD	I2 Current THD
I3 THD	I3 Current THD
I1 KF	I1 K-Factor
I2 KF	I2 K-Factor
I3 KF	I3 K-Factor
I1 TDD	I1 Current TDD

<b>Designation</b>	<b>Description</b>
I2 TDD	I2 Current TDD
I3 TDD	I3 Current TDD
V12	V12 Voltage
V23	V23 Voltage
V31	V31 Voltage
<b>RT TOTAL</b>	<b>1-Cycle Total Values</b>
kW	Total kW
kvar	Total kvar
kVA	Total kVA
PF	Total PF
PF LAG	Total PF lag
PF LEAD	Total PF lead
kW IMP	Total kW import
kW EXP	Total kW export
kvar IMP	Total kvar import
kvar EXP	Total kvar export
V AVG	3-phase average L-N/L-L voltage
V LL AVG	3-phase average L-L voltage
I AVG	3-phase average current
<b>RT AUX</b>	<b>1-Cycle Auxiliary Values</b>
In	In (neutral) Current
FREQ	Frequency
V UNB%	Voltage unbalance <sup>2</sup>
I UNB%	Current unbalance <sup>2</sup>
<b>AVR PHASE</b>	<b>1-Second Phase Values</b>
V1	V1/V12 Voltage
V2	V2/V23 Voltage
V3	V3/V31 Voltage
I1	I1 Current
I2	I2 Current
I3	I3 Current
kW L1	kW L1
kW L2	kW L2
kW L3	kW L3
kvar L1	kvar L1
kvar L2	kvar L2
kvar L3	kvar L3
kVA L1	kVA L1
kVA L2	kVA L2
kVA L3	kVA L3
PF L1	Power factor L1
PF L2	Power factor L2
PF L3	Power factor L3
V1 THD	V1/V12 Voltage THD <sup>1</sup>
V2 THD	V2/V23 Voltage THD <sup>1</sup>
V3 THD	V3/V31 Voltage THD <sup>1</sup>
I1 THD	I1 Current THD
I2 THD	I2 Current THD
I3 THD	I3 Current THD
I1 KF	I1 K-Factor

<b>Designation</b>	<b>Description</b>
I2 KF	I2 K-Factor
I3 KF	I3 K-Factor
I1 TDD	I1 Current TDD
I2 TDD	I2 Current TDD
I3 TDD	I3 Current TDD
V12	V12 Voltage
V23	V23 Voltage
V31	V31 Voltage
<b>AVR TOTAL</b>	<b>1-Second Total Values</b>
kW	Total kW
kvar	Total kvar
kVA	Total kVA
PF	Total PF
PF LAG	Total PF lag
PF LEAD	Total PF lead
kW IMP	Total kW import
kW EXP	Total kW export
kvar IMP	Total kvar import
kvar EXP	Total kvar export
V AVG	3-phase average L-N/L-L voltage <sup>1</sup>
V LL AVG	3-phase average L-L voltage
I AVG	3-phase average current
<b>AVR AUX</b>	<b>1-Second Auxiliary Values</b>
In	In (neutral) Current
FREQ	Frequency
V UNB%	Voltage unbalance <sup>2</sup>
I UNB%	Current unbalance <sup>2</sup>
<b>PHASORS</b>	<b>Phasors</b>
V1 Mag	V1/V12 Voltage magnitude <sup>1</sup>
V2 Mag	V2/V23 Voltage magnitude <sup>1</sup>
V3 Mag	V3/V31 Voltage magnitude <sup>1</sup>
I1 Mag	I1 Current magnitude
I2 Mag	I2 Current magnitude
I3 Mag	I3 Current magnitude
V1 Ang	V1/V12 Voltage angle <sup>1</sup>
V2 Ang	V2/V23 Voltage angle <sup>1</sup>
V3 Ang	V3/V31 Voltage angle <sup>1</sup>
I1 Ang	I1 Current angle
I2 Ang	I2 Current angle
I3 Ang	I3 Current angle
<b>DEMANDS</b>	<b>Present Demands (Power Demands E, EH)</b>
V1 DMD	V1/V12 Volt demand <sup>1</sup>
V2 DMD	V2/V23 Volt demand <sup>1</sup>
V3 DMD	V3/V31 Volt demand <sup>1</sup>
I1 DMD	I1 Ampere demand
I2 DMD	I2 Ampere demand
I3 DMD	I3 Ampere demand
kW IMP BD	kW import block demand
kvar IMP BD	kvar import block demand
kVA BD	kVA block demand

<b>Designation</b>	<b>Description</b>
kW IMP SD	kW import sliding window demand
kvar IMPSD	kvar import sliding window demand
kVA SD	kVA sliding window demand
kW IMP ACD	kW import accumulated demand
kvar IMP ACD	kvar import accumulated demand
kVA ACD	kVA accumulated demand
kW IMP PRD	kW import predicted sliding window demand
kvar IMP PRD	kvar import predicted sliding window demand
kVA PRD	kVA predicted sliding window demand
PF IMP@kVA DMD	PF (import) at Maximum kVA sliding window demand
kW EXP BD	kW export block demand
kvar EXP BD	kvar export block demand
kW EXP SD	kW export sliding window demand
kvar EXPSD	kvar export sliding window demand
kW EXP ACD	kW export accumulated demand
kvar EXP ACD	kvar export accumulated demand
kW EXP PRD	kW export predicted sliding window demand
kvar EXP PRD	kvar export predicted sliding window demand
In DMD	In (neutral) current demand
<b>SUMM ACC DMD</b>	<b>Billing Summary (Total) Accumulated Demands</b>
REG1 ACD	Register #1 accumulated demand
REG2 ACD	Register #2 accumulated demand
REG3 ACD	Register #3 accumulated demand
REG4 ACD	Register #4 accumulated demand
<b>SUMM BLK DMD</b>	<b>Billing Summary (Total) Block Demands</b>
REG1 BD	Register #1 block demand
REG2 BD	Register #2 block demand
REG3 BD	Register #3 block demand
REG4 BD	Register #4 block demand
<b>SUMM SW DMD</b>	<b>Billing Summary (Total) Sliding Demands</b>
REG1 SD	Register #1 sliding demand
REG2 SD	Register #2 sliding demand
REG3 SD	Register #3 sliding demand
REG4 SD	Register #4 sliding demand
<b>ENERGY</b>	<b>Total Energy</b>
kWh IMPORT	kWh import
kWh EXPORT	kWh export
kvarh IMPORT	kvarh import
kvarh EXPORT	kvarh export
kVAh TOTAL	kVAh total
<b>SUMMARY REGS</b>	<b>Billing Summary (Total and single phase) Energy Registers</b>
SUM REG1	Summary energy register #1
SUM REG2	Summary energy register #2
SUM REG3	Summary energy register #3
SUM REG4	Summary energy register #4
<b>PHASE ENERGY</b>	<b>Phase Energy</b>
kWh IMP L1	kWh import L1
kWh IMP L2	kWh import L2
kWh IMP L3	kWh import L3
kvarh IMP L1	kvarh import L1



Designation	Description
kvarh IMP L2	kvarh import L2
kvarh IMP L3	kvarh import L3
kVAh L1	kVAh total L1
kVAh L2	kVAh total L2
kVAh L3	kVAh total L3
<b>%HD V1</b>	<b>V1/V12 Harmonic Distortions <sup>EH1</sup></b>
V1 %HD01	H01 Harmonic distortion
V1 %HD02	H02 Harmonic distortion
...	...
V1 %HD40	H40 Harmonic distortion
<b>%HD V2</b>	<b>V2/V23 Harmonic Distortions <sup>EH1</sup></b>
V2 %HD01	H01 Harmonic distortion
V2 %HD02	H02 Harmonic distortion
...	...
V2 %HD40	H40 Harmonic distortion
<b>%HD V3</b>	<b>V3/V31 Harmonic Distortions <sup>EH1</sup></b>
V3 %HD01	H01 Harmonic distortion
V3 %HD02	H02 Harmonic distortion
...	...
V3 %HD40	H40 Harmonic distortion
<b>%HD I1</b>	<b>I1 Harmonic Distortions <sup>EH</sup></b>
I1 %HD01	H01 Harmonic distortion
I1 %HD02	H02 Harmonic distortion
...	...
I1 %HD40	H40 Harmonic distortion
<b>%HD I2</b>	<b>I2 Harmonic Distortions <sup>EH</sup></b>
I2 %HD01	H01 Harmonic distortion
I2 %HD02	H02 Harmonic distortion
...	...
I2 %HD40	H40 Harmonic distortion
<b>%HD I3</b>	<b>I3 Harmonic Distortions <sup>EH</sup></b>
I3 %HD01	H01 Harmonic distortion
I3 %HD02	H02 Harmonic distortion
...	...
I3 %HD40	H40 Harmonic distortion
<b>ANG V1</b>	<b>V1/V12 Harmonic Angles <sup>EH1</sup></b>
V1 H01 ANG	H01 Harmonic angle
V1 H02 ANG	H02 Harmonic angle
...	...
V1 H40 ANG	H40 Harmonic angle
<b>ANG V2</b>	<b>V2/V23 Harmonic Angles <sup>EH1</sup></b>
V2 H01 ANG	H01 Harmonic angle
V2 H02 ANG	H02 Harmonic angle
...	...
V2 H40 ANG	H40 Harmonic angle
<b>ANG V3</b>	<b>V3/V31 Harmonic Angles <sup>EH1</sup></b>
V3 H01 ANG	H01 Harmonic angle
V3 H02 ANG	H02 Harmonic angle
...	...
V3 H40 ANG	H40 Harmonic angle

<b>Designation</b>	<b>Description</b>
<b>ANG I1</b>	<b>I1 Harmonic Angles <sup>EH</sup></b>
I1 H01 ANG	H01 Harmonic angle
I1 H02 ANG	H02 Harmonic angle
...	...
I1 H40 ANG	H40 Harmonic angle
<b>ANG I2</b>	<b>I2 Harmonic Angles <sup>EH</sup></b>
I2 H01 ANG	H01 Harmonic angle
I2 H02 ANG	H02 Harmonic angle
...	...
I2 H40 ANG	H40 Harmonic angle
<b>ANG I3</b>	<b>I3 Harmonic Angles <sup>EH</sup></b>
I3 H01 ANG	H01 Harmonic angle
I3 H02 ANG	H02 Harmonic angle
...	...
I3 H40 ANG	H40 Harmonic angle
<b>H1 PHASE</b>	<b>Fundamental (H01) Phase Values</b>
V1 H01	V1/V12 Voltage <sup>1</sup>
V2 H01	V2/V23 Voltage <sup>1</sup>
V3 H01	V3/V31 Voltage <sup>1</sup>
I1 H01	I1 Current
I2 H01	I2 Current
I3 H01	I3 Current
kW L1 H01	kW L1
kW L2 H01	kW L2
kW L3 H01	kW L3
kvar L1 H01	kvar L1
kvar L2 H01	kvar L2
kvar L3 H01	kvar L3
kVA L1 H01	kVA L1
kVA L2 H01	kVA L2
kVA L3 H01	kVA L3
PF L1 H01	Power factor L1
PF L2 H01	Power factor L2
PF L3 H01	Power factor L3
<b>HRM TOT POW</b>	<b>Fundamental and Harmonic Total Power Values</b>
kW H01	Total fundamental kW
kvar H01	Total fundamental kvar
kVA H01	Total fundamental kVA
PF H01	Total fundamental PF
<b>MIN PHASE</b>	<b>Minimum 1-Cycle Phase Values</b>
V1 MIN	V1/V12 Voltage <sup>1</sup>
V2 MIN	V2/V23 Voltage <sup>1</sup>
V3 MIN	V3/V31 Voltage <sup>1</sup>
I1 MIN	I1 Current
I2 MIN	I2 Current
I3 MIN	I3 Current
<b>MIN TOTAL</b>	<b>Minimum 1-Cycle Total Values</b>
kW MIN	Total kW
kvar MIN	Total kvar
kVA MIN	Total kVA

Designation	Description
PF MIN	Total PF
<b>MIN AUX</b>	<b>Minimum 1-Cycle Auxiliary Values</b>
In MIN	In Current
FREQ MIN	Frequency
MAX PHASE	Maximum 1-Cycle Phase Values
<b>V1 MAX</b>	<b>V1/V12 Voltage <sup>1</sup></b>
V2 MAX	V2/V23 Voltage <sup>1</sup>
V3 MAX	V3/V31 Voltage <sup>1</sup>
I1 MAX	I1 Current
I2 MAX	I2 Current
I3 MAX	I3 Current
<b>MAX TOTAL</b>	<b>Maximum 1-Cycle Total Values</b>
kW MAX	Total kW
kvar MAX	Total kvar
kVA MAX	Total kVA
PF MAX	Total PF
<b>MAX AUX</b>	<b>Maximum 1-Cycle Auxiliary Values</b>
In MAX	In Current
FREQ MAX	Frequency
<b>MAX DMD</b>	<b>Maximum Demands (Power Demands E, EH)</b>
V1 DMD MAX	V1/V12 Maximum volt demand <sup>1</sup>
V2 DMD MAX	V2/V23 Maximum volt demand <sup>1</sup>
V3 DMD MAX	V3/V31 Maximum volt demand <sup>1</sup>
I1 DMD MAX	I1 Maximum ampere demand
I2 DMD MAX	I2 Maximum ampere demand
I3 DMD MAX	I3 Maximum ampere demand
kW IMP SD MAX	Maximum kW import sliding window demand
kW EXP SD MAX	Maximum kvar import sliding window demand
kvar IMP SD MAX	Maximum kW export sliding window demand
kvar EXP SD MAX	Maximum kvar export sliding window demand
kVA SD MAX	Maximum kVA sliding window demand
In DMD MAX	In (neutral) current maximum demand
<b>MAX SUMMARY DMD</b>	<b>Billing Summary (Total) Maximum Demands E, EH</b>
REG1 MD	Summary register #1 maximum demand
REG2 MD	Summary register #2 maximum demand
REG3 MD	Summary register #3 maximum demand
REG4 MD	Summary register #4 maximum demand
<b>AO RAW</b>	<b>Raw Analog Outputs (A/D Units)</b>
AO1	Analog output AO1
AO2	Analog output AO2
AO3	Analog output AO3
AO4	Analog output AO4
<b>TOU PRMS</b>	<b>TOU Parameters E, EH</b>
ACTIVE TARIFF	Active TOU tariff
ACTIVE PROFILE	Active TOU profile
<b>TOU REG1</b>	<b>Billing TOU Energy Register #1 E, EH</b>
REG1 TRF1	Tariff #1 register
REG1 TRF2	Tariff #2 register
...	...
REG1 TRF8	Tariff #8 register

<b>Designation</b>	<b>Description</b>
<b>TOU REG2</b>	<b>Billing TOU Energy Register #2 E, EH</b>
REG2 TRF1	Tariff #1 register
REG2 TRF2	Tariff #2 register
...	...
REG2 TRF8	Tariff #8 register
<b>TOU REG3</b>	<b>Billing TOU Energy Register #3 E, EH</b>
REG3 TRF1	Tariff #1 register
REG3 TRF2	Tariff #2 register
...	...
REG3 TRF8	Tariff #8 register
<b>TOU REG4</b>	<b>Billing TOU Energy Register #4 E, EH</b>
REG4 TRF1	Tariff #1 register
REG4 TRF2	Tariff #2 register
...	...
REG4 TRF8	Tariff #8 register
<b>TOU MAX DMD REG1</b>	<b>Billing TOU Maximum Demand Register #1 E, EH</b>
REG1 TRF1 MD	Tariff #1 maximum demand
REG1 TRF2 MD	Tariff #2 maximum demand
...	...
REG1 TRF8 MD	Tariff #8 maximum demand
<b>TOU MAX DMD REG2</b>	<b>Billing TOU Maximum Demand Register #2 E, EH</b>
REG2 TRF1 MD	Tariff #1 maximum demand
REG2 TRF2 MD	Tariff #2 maximum demand
...	...
REG2 TRF8 MD	Tariff #8 maximum demand
<b>TOU MAX DMD REG3</b>	<b>Billing TOU Maximum Demand Register #3 E, EH</b>
REG3 TRF1 MD	Tariff #1 maximum demand
REG3 TRF2 MD	Tariff #2 maximum demand
...	...
REG3 TRF8 MD	Tariff #8 maximum demand
<b>TOU MAX DMD REG4</b>	<b>Billing TOU Maximum Demand Register #4 E, EH</b>
REG4 TRF1 MD	Tariff #1 maximum demand
REG4 TRF2 MD	Tariff #2 maximum demand
...	...
REG4 TRF8 MD	Tariff #8 maximum demand

<sup>1</sup>In 4LN3, 3LN3 and 3BLN3 wiring modes, the voltages will be line-to-neutral; for any other wiring mode, they will be line-to-line voltages.

<sup>2</sup>The value is calculated as a relation of the maximum deviation of phase values from a 3-phase average value to a 3-phase average.

#### NOTE

Designations of some engineering demands and billing energy and demand registers are shown using a short name notation available in PAS V1.4. By default, PAS uses long names compatible with older versions of PAS. You can select a desired notation from the Tools/Options/Preferences tab.

PAS does not allow to store data in files using different data names. If you have a file uploaded with a previous version of PAS using long data

names, either continue using long data names, or store data in a new file.

See table below for a list of parameters with short and long names.

<b>Short Data Name</b>	<b>Long Data Name</b>	<b>Description</b>
KW IMP ACD	KW IMP ACC DMD	Accumulated demand
KW IMP PRD	KW IMP PRD DMD	Predicted sliding window demand
PF IMP@kVA MD	PF IMP@kVA MXDMD	PF (import) at maximum kVA demand
REG1 ACD	SUM REG1 ACC DMD	Billing summary (total) register accumulated demand
REG1 BD	SUM REG1 BLK DMD	Billing summary (total) register block demand
REG1 SD	SUM REG1 SW DMD	Billing summary (total) register sliding demand
REG1	SUM REG1	Billing summary (total) energy register
REG1 MD	SUM REG1 DMD MAX	Billing summary (total) register maximum demand
REG1 TRF1	TOU REG1 TRF1	Billing tariff energy register
REG1 TRF1 MD	DMD1 TRF1 MAX	Billing tariff register maximum demand
TRF1	SEASON TRF1	Generic billing tariff energy register
TRF1 MD	SEASON TRF1	Generic billing tariff register maximum demand

# Appendix F Billing/TOU Profile Log File

The following table shows the record structure for the daily billing data profile log file.

The second column shows data abbreviations used in the PAS data log reports. Data log file sections are highlighted in bold.

**Table 28: Daily Billing/TOU Profile Data Log (Data Log #16)**

<b>Field No.</b>	<b>Designation</b>	<b>Description</b>
<b>Energy Register #1</b>		
1	REG1	Summary (total) energy reading
2	TRF1	Tariff #1 energy reading
3	TRF2	Tariff #2 energy reading
4	TRF3	Tariff #3 energy reading
5	TRF4	Tariff #4 energy reading
6	TRF5	Tariff #5 energy reading
7	TRF6	Tariff #6 energy reading
8	TRF7	Tariff #7 energy reading
9	TRF8	Tariff #8 energy reading
...		
<b>Energy Register #4</b>		
1	REG4	Summary (total) energy reading
2	TRF1	Tariff #1 energy reading
3	TRF2	Tariff #2 energy reading
4	TRF3	Tariff #3 energy reading
5	TRF4	Tariff #4 energy reading
6	TRF5	Tariff #5 energy reading
7	TRF6	Tariff #6 energy reading
8	TRF7	Tariff #7 energy reading
9	TRF8	Tariff #8 energy reading
<b>Daily Maximum Demand Register #1</b>		
1	REG1 MD	Summary (total) max. demand reading
2	TRF1 MD	Tariff #1 max. demand reading
3	TRF2 MD	Tariff #2 max. demand reading
4	TRF3 MD	Tariff #3 max. demand reading
5	TRF4 MD	Tariff #4 max. demand reading
6	TRF5 MD	Tariff #5 max. demand reading
7	TRF6 MD	Tariff #6 max. demand reading
8	TRF7 MD	Tariff #7 max. demand reading
9	TRF8 MD	Tariff #8 max. demand reading
...		
<b>Daily Maximum Demand Register #4</b>		
1	REG4 MD	Summary (total) max. demand reading
2	TRF1 MD	Tariff #1 max. demand reading
3	TRF2 MD	Tariff #2 max. demand reading
4	TRF3 MD	Tariff #3 max. demand reading
5	TRF4 MD	Tariff #4 max. demand reading
6	TRF5 MD	Tariff #5 max. demand reading

<b>Field No.</b>	<b>Designation</b>	<b>Description</b>
7	TRF6 MD	Tariff #6 max. demand reading
8	TRF7 MD	Tariff #7 max. demand reading
9	TRF8 MD	Tariff #8 max. demand reading

The number of parameters in each section is automatically configured depending on the number of actual tariffs you defined in the TOU Daily Profiles.

## Appendix G Data Scales

The maximum values for volts, amps and power in the EM13X Series setup and in communications are limited by the voltage and current scale settings.

The following table shows the meter data scales.

**Table 29: Data Scales Values**

Scale	Conditions	Range
Maximum voltage (V max)	All configurations	Voltage scale $\times$ PT Ratio, V <sup>1</sup>
Maximum current (I max)	All configurations	Current scale $\times$ CT Ratio, A <sup>2, 3</sup>
Maximum Power <sup>4</sup>	Wiring 4LN3, 3LN3, 3BLN3	V max $\times$ I max $\times$ 3, W
	Wiring 4LL3, 3LL3, 3BLL3, 3OP2, 3OP3, 3DIR2	V max $\times$ I max $\times$ 2, W
Maximum frequency	25, 50 or 60 Hz	100 Hz
	400Hz	500 Hz

<sup>1</sup>The default voltage scale is 144V. The recommended voltage scale is 120V+20% = 144V for using with external PT's, and 690V+20% = 828V for a direct connection to power line.

<sup>2</sup>CT Ratio = CT primary current/CT secondary current

<sup>3</sup>The default current scale is 2  $\times$  CT secondary (2.0A with 1A secondary and 10.0A with 5A secondary).

<sup>4</sup>Maximum power is rounded to whole kilowatts. With PT=1.0, it is limited to 9,999,000 W.



## Appendix H Device Diagnostic Codes

**Table 30: Device Diagnostic Codes**

<b>Diagnostic Code</b>	<b>Description</b>	<b>Reason</b>
2	Memory/Data fault	Hardware failure
3	Hardware watchdog reset	Hardware failure
5	CPU exception	Hardware failure
6	Run-time software error	Hardware failure
7	Software watchdog timeout	Hardware failure
8	Power Down/Up	Normal power-up sequence
9	Warm restart	External restart via communications or by firmware upgrade
10	Configuration reset	Corrupted setup data has been replaced with the default configuration
11	RTC fault	The clock time has been lost
13	Low battery (with a battery backup unit)	Battery replacement is required
15	EEPROM fault	Hardware failure