



Phasor Measurement Unit PMU PRO

Installation and Operation Manual



LIMITED WARRANTY

The manufacturer offers the customer a 24-month functional warranty on the instrument for faulty workmanship or parts from date of dispatch from the distributor. In all cases, this warranty is valid for 36 months from the date of production. This warranty is on a return to factory basis.

The manufacturer does not accept liability for any damage caused by instrument malfunction. The manufacturer accepts no responsibility for the suitability of the instrument to the application for which it was purchased.

Failure to install, set up or operate the instrument according to the instructions herein will void the warranty.

Only a duly authorized representative of the manufacturer may open your instrument. The unit should only be opened in a fully anti-static environment. Failure to do so may damage the electronic components and will void the warranty.

The greatest care has been taken to manufacture and calibrate your instrument. However, these instructions do not cover all possible contingencies that may arise during installation, operation or maintenance, and all details and variations of this equipment are not covered by these instructions.

For additional information regarding installation, operation or maintenance of this instrument, contact the manufacturer or your local representative or distributor.

WARNING

Read the instructions in this manual before performing installation, and take note of the following precautions:



Ensure that all incoming AC power and other power sources are turned off before performing any work on the instrument. Failure to do so may result in serious or even fatal injury and/or equipment damage.



Before connecting the instrument to the power source, check the labels on the front and side of the instrument to ensure that your instrument is equipped with the appropriate power supply voltage, input voltages and currents.



Under no circumstances should the instrument be connected to a power source if it is damaged.



To prevent potential fire or shock hazard, do not expose the instrument to rain or moisture.



The secondary of an external current transformer must never be allowed to be open circuit when the primary is energized. An open circuit can cause high voltages, possibly resulting in equipment damage, fire and even serious or fatal injury. Ensure that the current transformer wiring is secured using an external strain relief to reduce mechanical strain on the screw terminals, if necessary.



Only qualified personnel familiar with the instrument and its associated electrical equipment must perform setup procedures.



Do not open the instrument under any circumstances when it is connected to a power source.



Do not use the instrument for primary protection functions where failure of the device can cause fire, injury or death. The instrument can only be used for secondary protection if needed.



Read this manual thoroughly before connecting the device to the current carrying circuits. During operation of the device, hazardous voltages are present on input terminals. Failure to observe precautions can result in serious or even fatal injury or damage to equipment.

All trademarks are property of their respective owners

January 2025

Copyright 2024 © SATEC Ltd.

Table of Contents

- 1 General7
- 2 Installation 11
- 2.1 Mechanical Installation 11
- 2.2 Mounting Expansion Modules..... 12
- 2.3 Electrical Installation..... 13
 - 2.3.1 Power Supply Connection14
 - 2.3.2 Voltage Inputs Connection.....14
 - 2.3.3 Current Inputs Connection.....15
 - 2.3.4 Built-in I/O Connection.....15
 - 2.3.5 Auxiliary Power Supply Connection16
 - 2.3.6 Expansion I/O Modules Connection.....16
 - 2.3.7 Communication Connections18
- 3 Operating the PMU 21
- 3.1 Device Security..... 21
- 3.2 Device Diagnostics 21
- 3.3 Monitoring the Battery 21
- 3.4 Clock and Time Synchronization..... 22
 - 3.4.1 IRIG-B Time Synchronization22
 - 3.4.2 IEEE 1588 PTP Time Synchronization22
- 3.5 Synchrophasor Measurements 23
 - 3.5.1 Synchrophasor Estimation23
 - 3.5.2 Frequency and ROCOF Estimation24
 - 3.5.3 Reporting Rates.....24
- 3.6 Instrumentation Measurements 24
- 3.7 Instrument Transformer Correction..... 24
- 3.8 Operating Logic Controller 24
- 3.9 Operating Device I/O..... 25
 - 3.9.1 Operating Digital Inputs25
 - 3.9.2 Operating Relay Outputs.....25
 - 3.9.3 Operating Analog Input.....25
- 3.10 Operating Recorders..... 26
 - 3.10.1 Operating the Event Recorder26
 - 3.10.2 Operating the Data Recorder26
- 3.11 Communicating with the PMU 26
 - 3.11.1 Internet Communications26
 - 3.11.2 Telnet Communications27
 - 3.11.3 Modbus Communications28
 - 3.11.4 DNP3 Communications29
 - 3.11.5 IEEE C37.118.2 Communications29
 - 3.11.6 IEC 61850 Communications31
 - 3.11.7 IEC 60870 Communications32
- 4 Using the Front Display 34
- 4.1 Controls and Indicators 34
 - 4.1.1 Status LEDs34
 - 4.1.2 Status Indicators.....35
- 4.2 Operating the Display..... 36
 - 4.2.1 Display Features36

4.2.2	Navigation Buttons.....	37
4.2.3	Menu Navigation.....	37
4.2.4	Entering Parameters	38
4.3	Display Menus.....	39
4.3.1	Main Menu.....	39
4.3.2	Favorites Menu	40
4.3.3	Monitor Menus	41
4.3.4	Phasor Diagram	45
4.3.5	Trend Graph	45
4.3.6	Events Menu	45
4.3.7	Setup Menus	46
5	Setting Up the PMU.....	49
5.1	Authorization	49
5.2	General Device Settings	49
5.2.1	Basic Setup	49
5.2.2	Transformer Correction.....	51
5.2.3	Display Setup.....	52
5.2.4	Device Localization.....	53
5.2.5	Configuring Digital Inputs.....	55
5.2.6	Configuring Relay Outputs	56
5.2.7	Configuring Analog Input	58
5.2.8	Configuring Counters	59
5.2.9	Configuring Periodic Timers	60
5.2.10	Configuring the Logic Controller	61
5.3	Configuring Communication	65
5.3.1	Network Setup	65
5.3.2	Serial Communications.....	66
5.3.3	Configuring the TCP Notification Client	68
5.3.4	Configuring the eXpertPower Client	68
5.4	Configuring Recorders.....	69
5.4.1	Configuring Log Files	69
5.4.2	Configuring the Data Recorder	71
6	Device Management	72
6.1	Configuring User Passwords	72
6.2	Setting Up Device Clock.....	72
6.3	Manual Relay Control.....	73
6.4	Manual Event Flag Control.....	74
6.5	Viewing and Clearing Device Diagnostics	74
6.6	Clearing Counters	75
6.7	Clearing Files	76
6.8	Firmware Update.....	77
7	Using PAS.....	79
7.1	Working with PAS	79
7.1.1	Software Installation	79
7.1.2	Creating a Site for your Device.....	79
7.1.3	Setting up Communications	81
7.1.4	Configuring the Device	83
7.2	Monitoring Devices.....	85
7.2.1	Viewing Device Properties	85
7.2.2	Viewing Real-time Data.....	86

7.2.3	Real-time Data Logging	89
7.3	Viewing Event and Data Files On-line.....	89
7.4	Retrieving and Storing Files.....	90
7.4.1	Retrieving Files on Demand	90
7.4.2	Using the Upload Scheduler	91
7.4.3	Exporting Files	92
7.4.4	Archiving Files.....	93
7.4.5	Compacting Files	94
7.5	Viewing Files.....	95
7.5.1	Working with Files.....	95
7.5.2	Viewing Options	96
7.5.3	Viewing the Event Log.....	98
7.5.4	Viewing the Data Log	99
Appendix A	Technical Specifications.....	101
Appendix B	Measurement Specifications	106
Appendix C	Measured Parameters	108
Appendix D	Data Scales	114
Appendix E	Diagnostic Messages.....	115

1 General



The PMU is a compact DIN rail mounted phasor measurement unit (PMU) designed to meet the requirements of users ranging from electrical panel builders to substation operators.

The PMU provides synchrophasor and frequency measurements compliant with the P and M performance classes of IEEE C37.118.1/1a and IEC/IEEE 60255-118-1:2018 standards.

PMU Features

- IEEE C37.118.1 compliant three-phase voltage, current, and positive and negative sequence phasor measurements synchronized to a common UTC time reference
- IEEE C37.118.1 synchronous frequency and rate of change of frequency (ROCOF) measurements
- Clock synchronization to a UTC time reference using an IRIG-B timecode source or an IEEE 1588 PTPv2 master clock source
- IEEE C37.118.2 commanded client-server UDP and TCP data transmission and spontaneous UDP data transmission over IP protocol
- IEEE C37.118.2 reporting rates from 1 to 200/240 frames/s
- Optional IEEE C37.118.2 data extensions with analog data (total fundamental active, reactive and apparent power and displacement power factor), and digital status data
- Streaming of phasor data over Ethernet using the IEC 61850-9-2 multicast sampled value (SV) service with IEEE C37.118.2 compliant mapping of synchrophasor data upon IEC 61850-9-2 and IEC 61850-90-5 guidelines

On-board Event and Data Recording

- 16 GB eMMC flash memory for long-term event and data recording
- Event recorder for logging internal diagnostic events, power faults and operations of the logic controller and digital I/O

- Eight data recorders with programmable datasets for data logging on a periodic basis and on any internal or external trigger

Programmable Logic Controller

- Programmable logic controller with 32 control setpoints and half-cycle scan time
- OR/AND logic, extensive triggers, programmable thresholds and delays, relay control, event-driven data recording
- 32 digital counters for counting internal events and pulses from external sources
- 16 interval timers with programmable periods from half cycle to 24 hours for periodic recording and triggering timed operations

Time and Clock

- High-accuracy real-time clock with a lithium backup battery
- Clock synchronization to a UTC time reference using an IRIG-B timecode source or an IEEE 1588 PTPv2 master clock
- Daylight saving time shift for local time indication with configurable DST start and end time

Extended Security

- 3-level password security for protecting device setups and recorded data from unauthorized changes

Display

- High contrast 1.77" TFT color graphics display with configurable backlight
- Multi-page displays; time, instrumentation and service data
- Menu-driven setups
- Multilanguage support

Built-in Digital and Analog I/O

- One optically isolated 24VDC dry contact input with programmable de-bounce time; steady-state and pulse operations; normal and inverting polarity
- One solid state relay output; unlatched, latched and pulse operations; failsafe operation for alarm notifications; programmable pulse width; direct remote relay control through communications
- One optically isolated analog input with user selectable input range of 0-1 mA, +/-1 mA, 0-20 mA or 4-20 mA

Expansion Digital I/O Options

- Up to three I/O expansion modules can be daisy-chained into the side expansion connector
- 8DI module option with eight optically isolated digital inputs; dry contacts or 24V, 48V, 125V and 250V wet contacts options

- 4RO module option with four electro-mechanical or solid-state relays
- 4DI/2RO module option with four optically isolated digital inputs and two electro-mechanical or solid-state relays

Communications Options

- Two 10/100Base-T IEEE 1588 Ethernet ports with packet forwarding/routing capabilities; connecting to Ethernet through one or two different network switches, or daisy chaining multiple devices to a switch using a linear or ring network topology (daisy chaining is not available for PTP-enabled devices); up to 8 simultaneous TCP connections via Modbus TCP, DNP3, IEC 60870-5-104, IEC 61850 (up to 5 client associations, GOOSE and MSV publishers) protocols; up to 5 TCP or/and UDP synchrophasor data streams via C37.118.2 protocol
- Full speed USB 2.0 type C port for local configuring and monitoring the device via Modbus RTU protocol
- RS-485 serial communication port; 2400 to 115200 bps; Modbus RTU/ASCII, DNP3 and IEC 60870-5-101 protocols (the port is not operational if the IRIG-B time synchronization source is used).
- Modbus TCP notification client
- eXpertPower™ client

Backup Power Supply

- Auxiliary 88-264 VAC/125-300 VDC 50/60 Hz power supply expansion module

Upgradeable Firmware

- New features can be easily added to the device by simply replacing firmware through any communication port

Software Support

- PAS – free configuration and data acquisition tool for remote configuring and monitoring the device
- Exporting data in Microsoft Excel workbook, CSV, or Electrotek PQDIF file format
- eXpertPower™ – SATEC proprietary Internet services

Product documentation

- BG0650 PMU Modbus Protocol Reference Guide
- BG0651 PMU DNP3 Protocol Reference Guide
- BG0652 PMU IEC 60870-5 Protocol Reference Guide
- BG0653 PMU IEC 61850 Protocol Reference Guide
- BG0654 PMU IEC 61850 Protocol Implementation Conformance Statement (PICS)
- BG0655 PMU IEEE C37.118.2 Protocol Reference Guide

Reference documents

- IEEE Std C37.118.1-2011, IEEE Standard for Synchrophasor Measurements for Power Systems
- IEEE Std C37.118.1a-2014, IEEE Standard for Synchrophasor Measurements for Power Systems, Amendment 1: Modification of Selected Performance Requirements
- IEEE Std C37.118.2-2011, IEEE Standard for Synchrophasor Data Transfer for Power Systems
- IEC/IEEE 60255-118-1:2018, Measuring relays and protection equipment – Part 118-1: Synchrophasor for power systems – Measurements
- IEC/TR 61850-90-5:2012, Communication networks and systems for power utility automation – Part 90-5: Use of IEC 61850 to transmit synchrophasor information according to IEEE C37.118
- IEEE Std 1588-2008, IEEE Standard for a Precision Clock Synchronization Protocol for Networked Measurement and Control Systems
- IEEE Std C37.238-2017, IEEE Standard Profile for Use of IEEE 1588 Precision Time Protocol in Power System Applications

2 Installation

2.1 Mechanical Installation

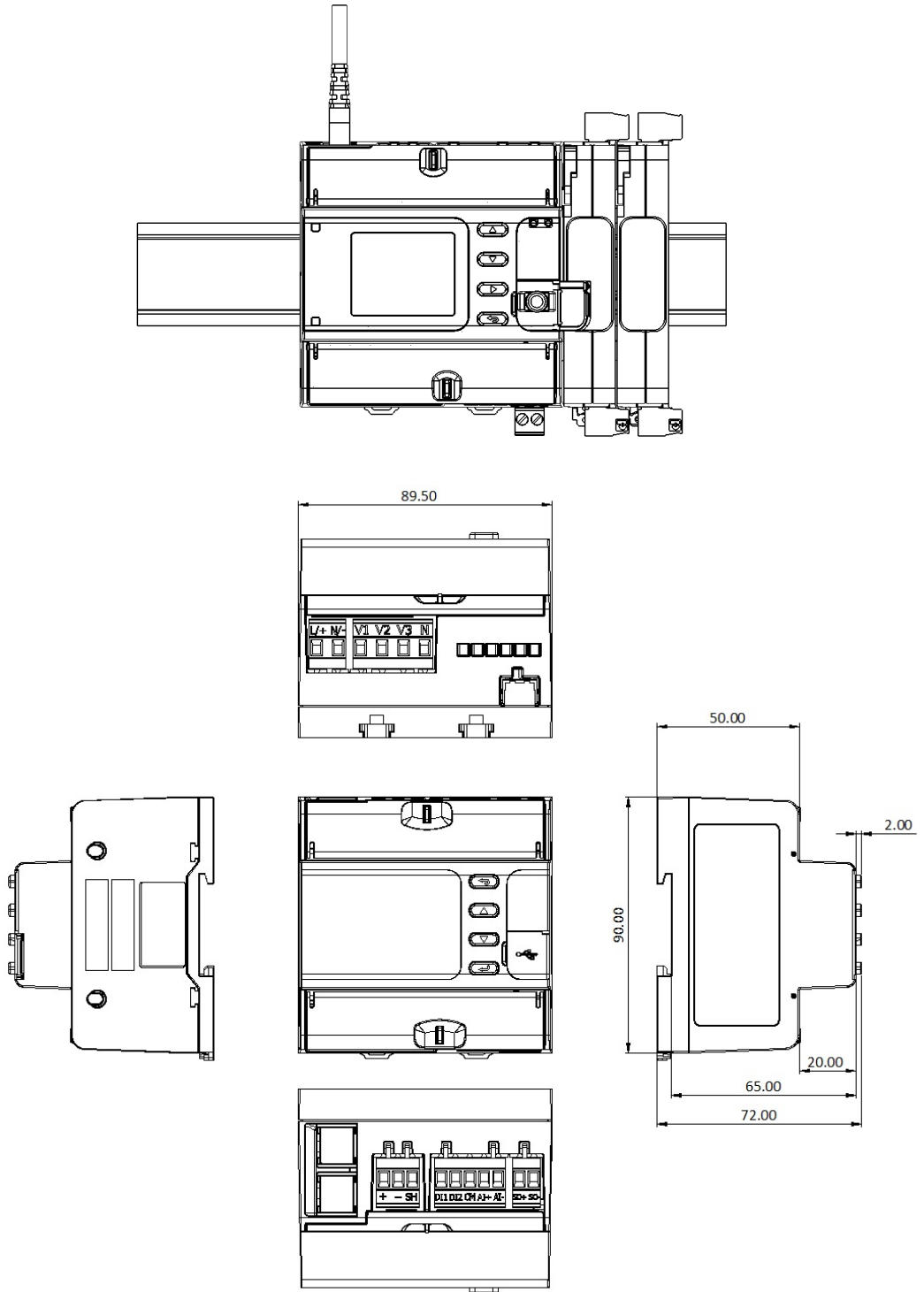

Figure 2-1 Device Dimensions and Mounting

2.2 Mounting Expansion Modules

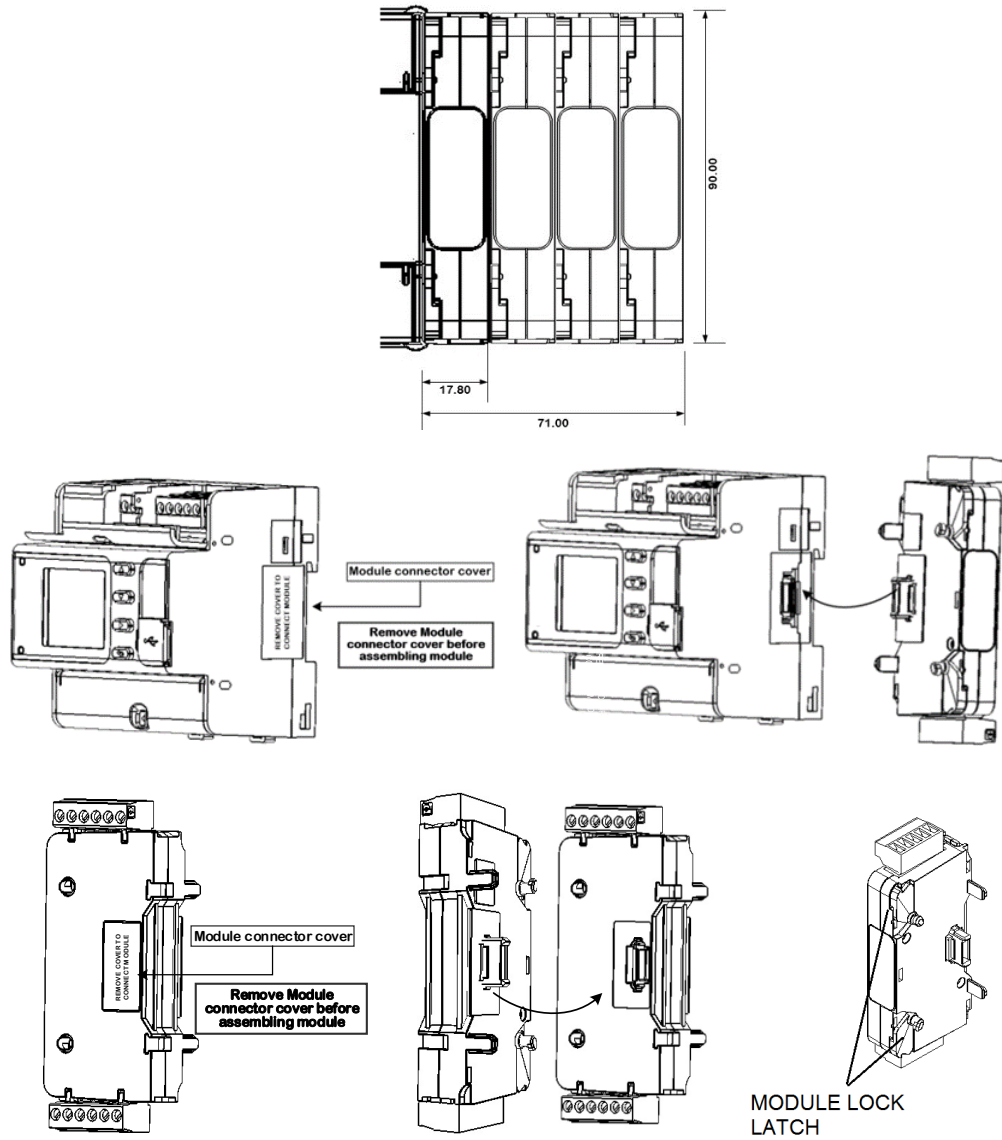

Figure 2-2 Expansion Module Dimensions and Mounting

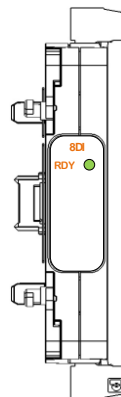

Figure 2-3 Expansion Module (front view)

2.3 Electrical Installation

⚠ Before installation ensure that all incoming power sources are turned off. Failure to observe this practice can result in serious or even fatal injury and damage to equipment.

Connections to the PMU are made via front terminals as shown in Figure 2-5.



Please pay attention to the following notes before installation:

- Under no circumstances should the instrument be connected to a power source if it is damaged.
- Before connecting the instrument to the power source, check the labels on the front and side of the instrument to ensure that your instrument is equipped with the appropriate power supply, voltage inputs and current inputs.
- The secondary of an external current transformer must never be allowed to be open circuit when the primary is energized. An open circuit can cause high voltages, possibly resulting in equipment damage, fire and even serious or fatal injury. Ensure that the current transformer wiring is secured using an external strain relief to reduce mechanical strain on the screw terminals, if necessary.
- When mounting the instrument on a DIN rail inside a switchgear, the metal plate of the switchgear must be grounded for safety purposes.
- Use a 2A low-voltage circuit breaker before connecting the voltage inputs to mains.
- Use non-insulated ferrules, such as Panduit Pan-Term® F77-8-M  for wire termination.
- Provide adequate segregation or barrier separation between the different classes of circuits: **(a)** Class 1 field and factory wiring (CT output leads, voltage measurement leads, mains input power), terminals, and bare live parts, and **(b)** Class 2 and Class 3 field and factory wiring, terminals, and non-insulated live parts.

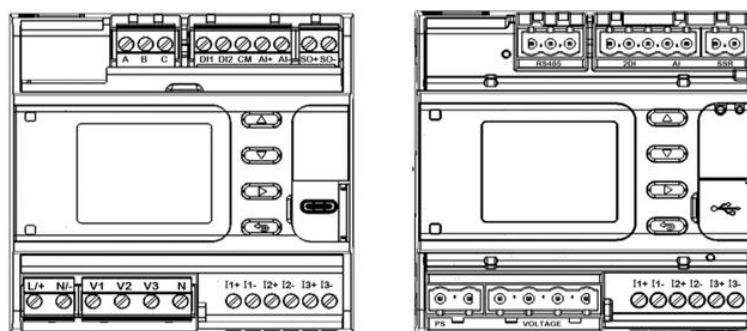

Figure 2-4 Device Terminals (front view, with and without plug-in terminals)

All connection terminals except of current input terminals are detachable plug-in terminals. Measurement terminals and digital and analog I/O terminals are protected with sealable covers against unauthorized access or unwanted human contact.

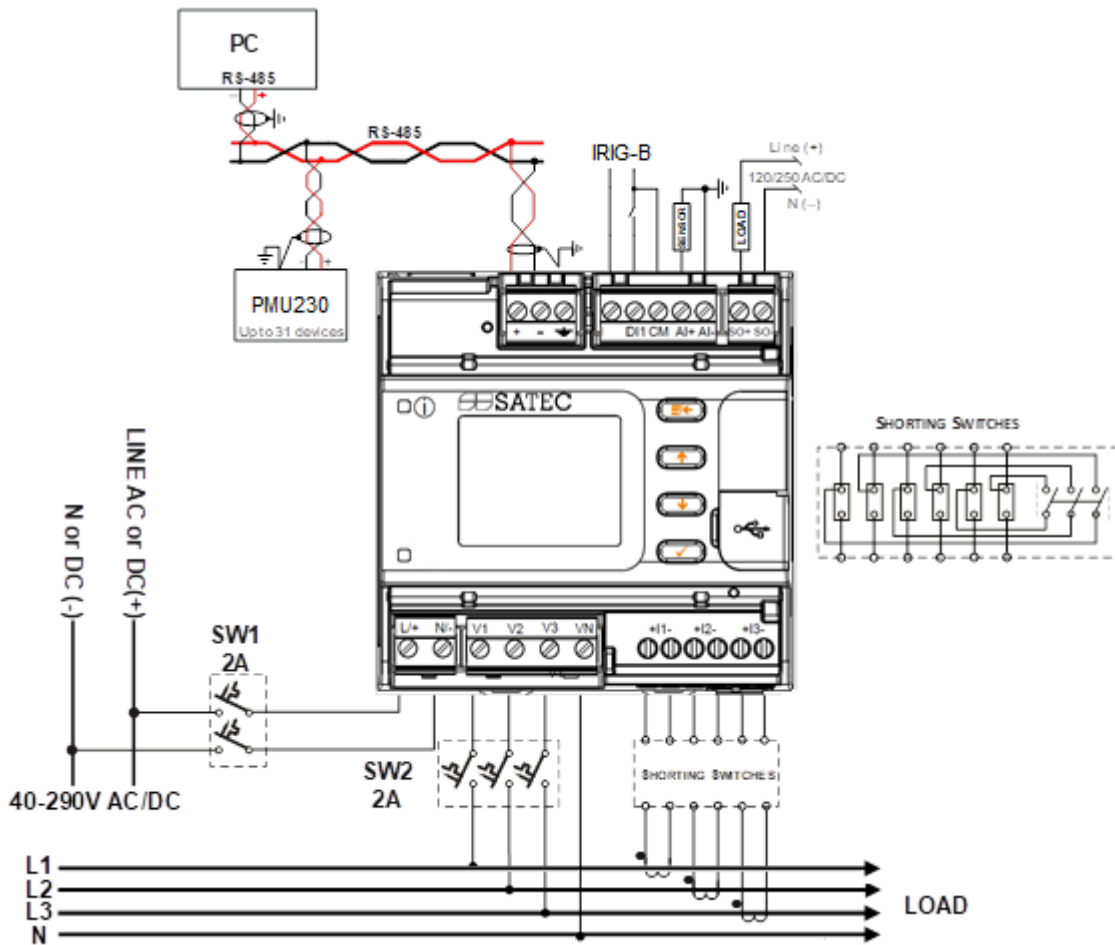

Figure 2-5 PMU Connections

2.3.1 Power Supply Connection

The power supply can be dedicated-fused, or from a monitored voltage if it is within the instrument power supply range. For AC power supply, connect line to terminal L/+ and neutral to terminal N/-. For DC power supply, connect positive wire to terminal L/+ and negative to terminal N/-

Use an external circuit breaker or switch for safety purposes.

2.3.2 Voltage Inputs Connection

Connect the mains voltage wires to terminals V1, V2, V2 and the neutral wire to terminal N.

Voltages in the range of up to 277/480 VAC can be connected directly to the device voltage terminals. Voltages above 277/480 VAC must be connected via potential transformers. See Figure 2-6 and Figure 2-7 for connection diagram.

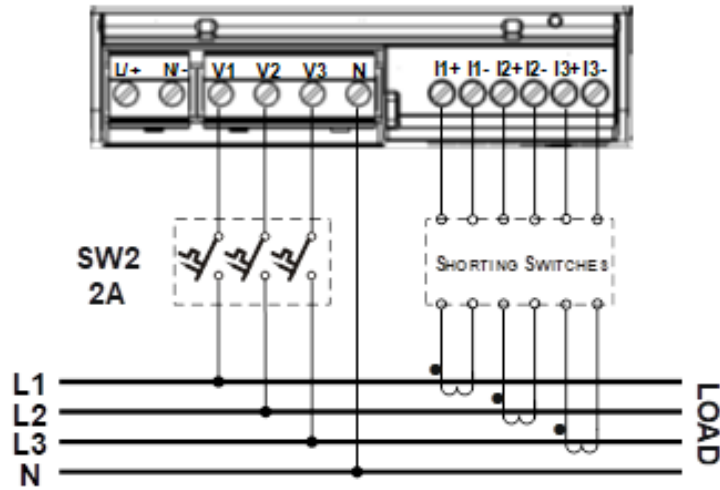

Figure 2-6 4-wire WYE Direct Connection

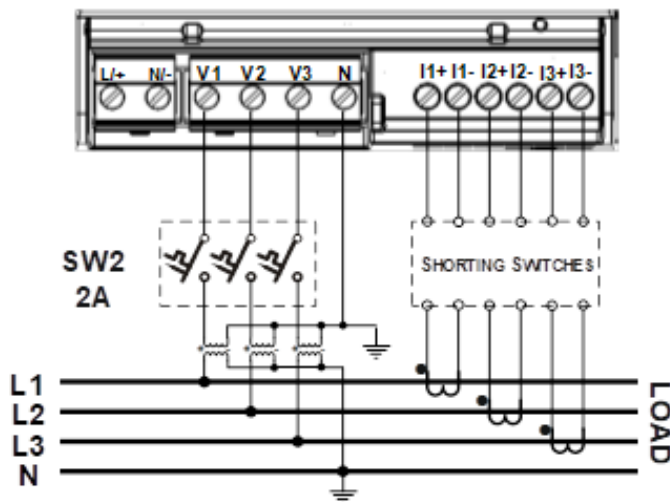

Figure 2-7 4-wire WYE PT Connection

2.3.3 Current Inputs Connection

Connect input current wires to terminals I1+/I1-, I2+/I2-, and I3+/I3-.

See Figure 2-6 and Figure 2-7 for connection diagram.

2.3.4 Built-in I/O Connection

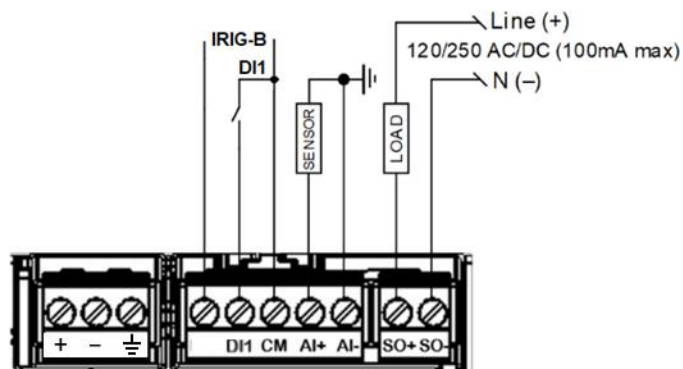

Figure 2-8 PMU Built-in I/O Terminals

Relay Output

One built-in solid-state SPST Form A relay is provided, rated at 100 mA/250 VAC/VDC. Connect the relay load between terminals SO+ and SO-. See Figure 2-8 for relay connections.

Digital Input

One built-in optically isolated self-powered 24VDC dry contact input is provided for monitoring external dry contacts. Connect the external contacts between terminals DI1 and CM. See Figure 2-8 for digital input connections.

Analog Input

One built-in optically isolated analog input is provided with a user selectable input range of 0-1 mA, +/-1 mA, 0-20 mA or 4-20 mA. See Figure 2-8 for analog input connections.

IRIG-B Port

The IRIG-B port uses an unmodulated (pulse width coded) time code signal (5V unbalanced level) in accordance with the IRIG 200-04 standard. It supports B004 and B005 timecode formats with the timecode extensions specified for the IRIG-B profile in Annex D of IEEE C37.118.1-2011.

The IRIG-B port shares a common terminal with digital input DI1. See Figure 2-8 for IRIG-B connections.

NOTE: The IRIG-B port shares input circuitry with the RS-485 port, so only one of them can be used at a time.

2.3.5 Auxiliary Power Supply Connection

The auxiliary power supply module is designed to increase the power ability of the device. It is connected in series with the I/O expansion modules on the side expansion connector. Allowable external voltage range is 88-264 VAC or 125-300 VDC.



Figure 2-9 Auxiliary Power Supply Connection

2.3.6 Expansion I/O Modules Connection

Up to 2 expansion modules can be normally connected to the side expansion terminal without overloading the device power supply. **Connecting the third expansion module requires the auxiliary power supply to be used.**

For I/O ratings, see the expansion I/O specifications in Appendix A .

8DI Expansion Module

The 8DI expansion module provides additional 8 optically isolated dry contact or wet contact digital inputs. See the following figures for module connections.



Figure 2-10 8DI Dry Contact Module Connection



Figure 2-11 8DI Wet Contact Module Connection

Dry contact modules use the internal 24VDC power supply. For wet contact modules, use an external power supply with an operating voltage of 24V, 48V, 125V or 250V, which can be connected in any polarity.

4RO Expansion Module

The 4RO expansion module provides four electro-mechanical or solid-state relays.



Figure 2-12 4RO Module Connection

4DI/2RO Expansion Module

The combined 4DI/2RO expansion module provides four dry contact or wet contact optically isolated digital inputs and two electro-mechanical or solid-state relays.

Dry contact inputs have an internal 24VDC power supply. For wet contact inputs, use an external power supply with an operating voltage of 24V, 48V, 125V or 250V, which can be connected in any polarity.



Figure 2-13 Dry Contact Inputs Connection



Figure 2-14 Wet Contact Inputs Connection

2.3.7 Communication Connections

See Figure 2-15 for the location of the PMU communication ports.

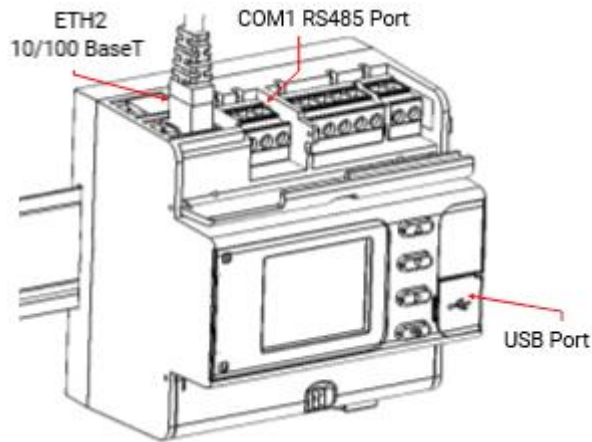

Figure 2-15 Communication Ports Location

RS-485 Serial Port

The built-in RS-485 port with user-configurable response delay and inter-message break timeout can operate at speeds from 2400 to 115200 bps with 7E, 8N and 8E data formats. The port is designated as COM1. See Figure 2-16 for recommended port connections.

NOTE: The RS-485 port shares input circuitry with the IRIG-B port, so only one of them can be used at a time.

The RS-485 port supports Modbus/RTU, Modbus/ASCII, DNP3 and IEC 60870-101 serial communication protocols.

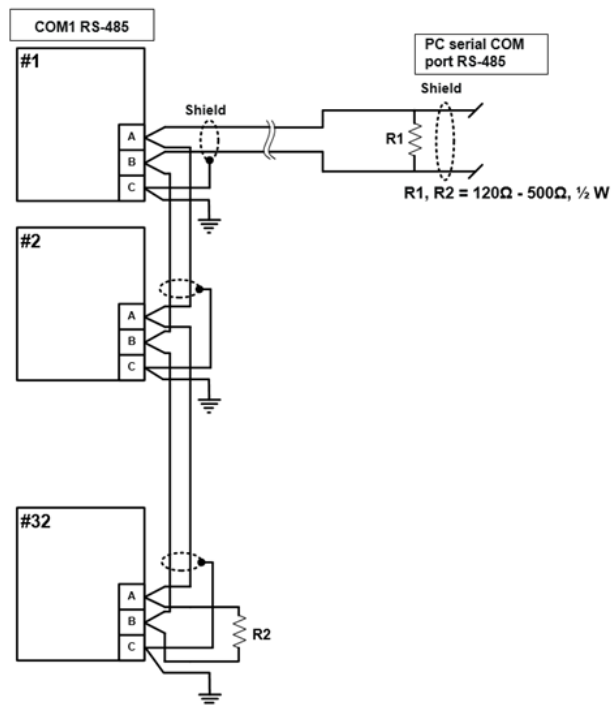

Figure 2-16 RS-485 Port Connection

USB Port

The PMU USB port is a full speed USB 2.0 port equipped with a Type C receptacle. It is operated over Modbus RTU protocol on Windows 7, 10 and 11 using a proprietary device driver.

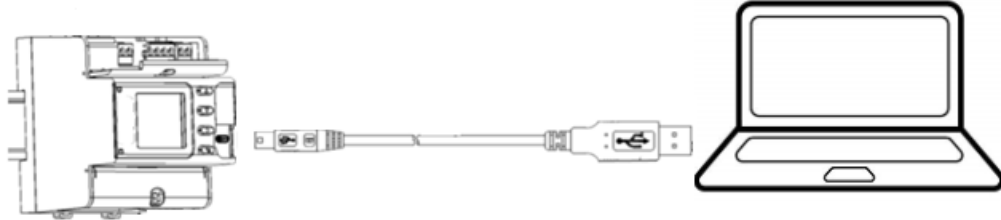

Figure 2-17 USB Port Connection

Use a USB Type C cable to connect your PC to the PMU USB port. To prevent potential differences between the PMU and PC USB ports, it is recommended to use a galvanically isolated USB adaptor or a battery powered PC.

Ethernet Ports

Two 10/100Base-T IEEE 1588 Ethernet ports with packet forwarding/routing capabilities allow direct connecting to Ethernet through one or two different network switches, or daisy chaining multiple devices to a switch using a linear or ring network topology. The ports are equipped with RJ-45 connectors.

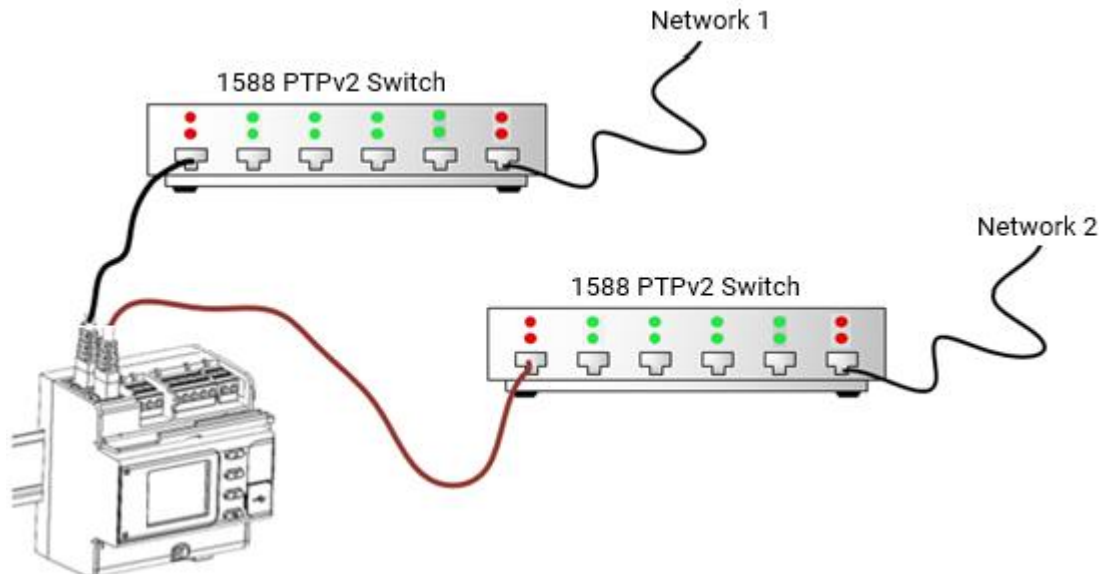

Figure 2-18 Direct Ethernet Connection (separated port mode)

NOTE

Daisy chaining is not available for PTP-enabled devices. Only one of them, directly connected to the 1588 switch, can have PTP synchronization enabled, and only using a linear topology.

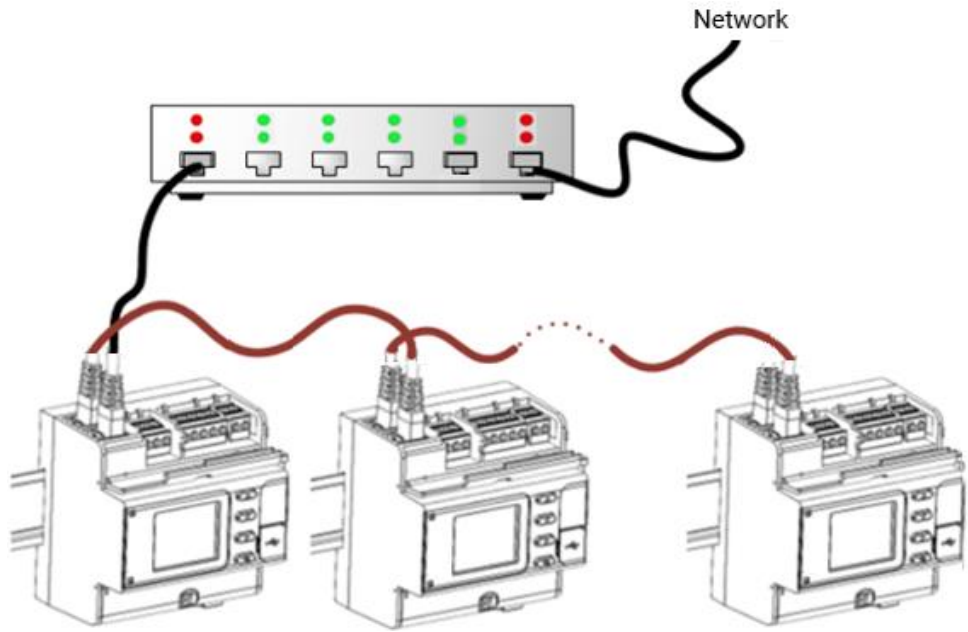

Figure 2-19 Daisy Chain Connection with Linear Topology (daisy chain port mode)

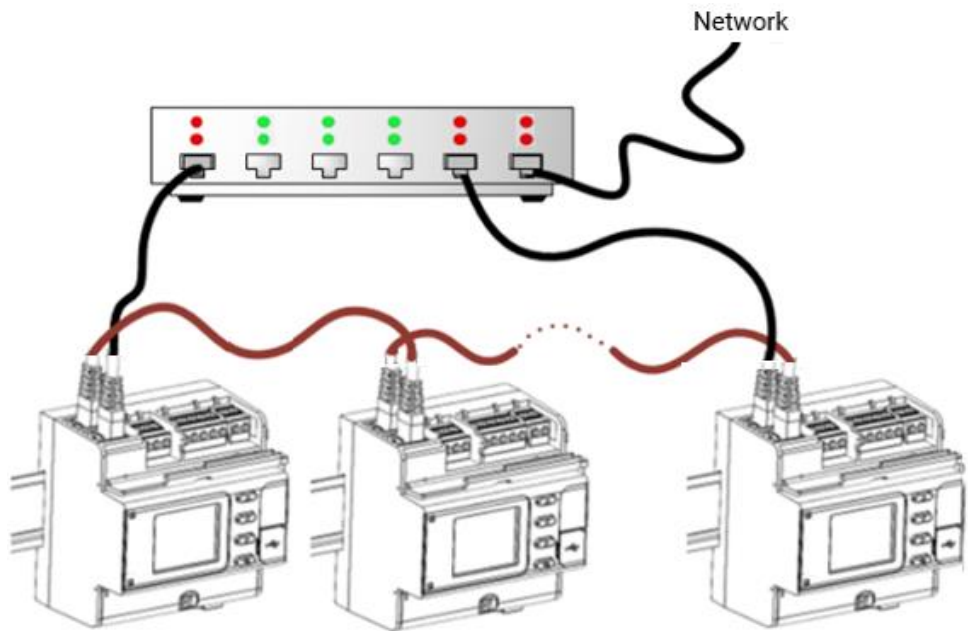

Figure 2-20 Daisy Chain Connection with Ring Topology (daisy chain port mode)

3 Operating the PMU

3.1 Device Security

The PMU provides 3-level password security with 8-digit user passwords to protect device configuration settings and stored data from unauthorized changes. Access to particular setup and control items is granted depending on the security level of the password you entered as shown in the following table.

Password	Security level	Access rights
Password 1	Low	Device diagnostics Clock update Display setup
Password 2	Medium	Reset of pulse counters Communication setup I/O operation setup and control Memory and recorders setup Telnet
Password 3	High (administration level)	Password setup Basic device setup Reset of log files

You will be prompted to enter the password each time you enter the device's setup menus. The device is shipped with a factory-set password of 9. See 6.1 "Configuring User Passwords" for information on how to configure passwords in your device.

Additionally, mechanical means are used to secure device connection terminals. Measurement terminals and digital and analog I/O terminals are protected with sealable covers against unauthorized access or unwanted human contact.

3.2 Device Diagnostics

Device diagnostic messages may appear as a result of the PMU built-in diagnostic tests performed during start-up and device operation.

See 4.1.2 "Status Indicators" for diagnostic indications on the front display.

All diagnostic events with time stamps are recorded in the device event log and can be inspected through the front display (see 4.3.6 "Events Menu") and through PAS (see 7.5.3 "Viewing the Event Log"). See 6.5 "Viewing and Clearing Device Diagnostics" for how to clear device diagnostics in your device.

See Appendix E "Diagnostic Messages" for the list of diagnostic messages and troubleshooting device issues.

3.3 Monitoring the Battery

A backup lithium battery keeps the device clock running when the power is removed from the device.

You can see the status of the battery in the display status bar (see 4.1.2 "Status Indicators") and via the device diagnostics.

3.4 Clock and Time Synchronization

Time synchronization provides a common time basis for synchrophasor measurements and data recorders.

The PMU clock must be synchronized to UTC time using an external IRIG-B timecode source or from an IEEE 1588 PTPv2 master clock.

You can see the clock status in the status bar on the front display and check the time quality on the Monitor/Clock Status screen (see “Device Clock Status” in 4.3.3).

You can also check the clock status and time accuracy via Telnet using the “time” command as shown in the following picture.

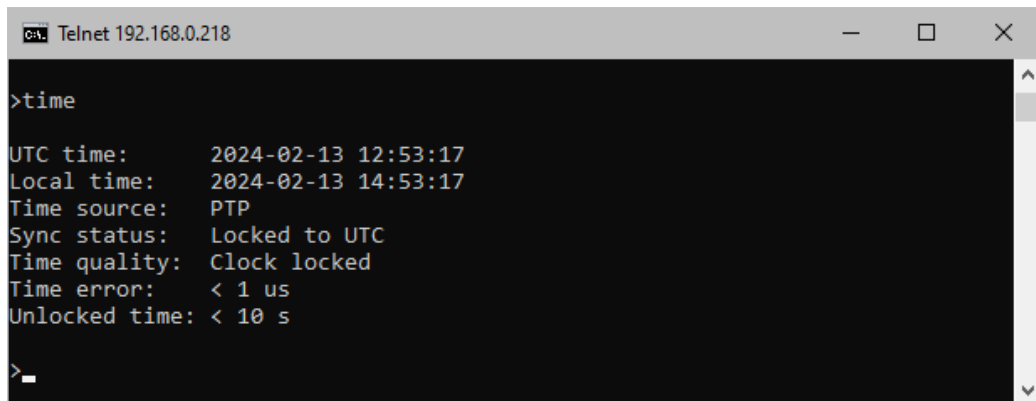

```
Telnet 192.168.0.218
>time
UTC time:      2024-02-13 12:53:17
Local time:    2024-02-13 14:53:17
Time source:   PTP
Sync status:   Locked to UTC
Time quality:  Clock locked
Time error:    < 1 us
Unlocked time: < 10 s
>
```

3.4.1 IRIG-B Time Synchronization

To enable the IRIG-B port as a UTC source, select the IRIG-B time synchronization option in the device Local Settings setup.

The IRIG-B port uses an unmodulated (pulse-width coded) timecode signal (unbalanced 5V level) according to the IRIG 200-04 standard. It supports B004/B005 timecode formats with time code extensions specified for the IRIG-B profile in Annex D of IEEE Std C37.118.1-2011.

The IRIG-B port can synchronize to the IRIG-B timecode source with sub-microsecond accuracy.

3.4.2 IEEE 1588 PTP Time Synchronization

The Ethernet port must be connected to an IEEE 1588 grandmaster clock through a 1588 PTPv2 peer-to-peer transparent clock switch compliant with IEEE Std 1588-2008 and IEEE C37.238 power profile.

To enable 1588 Ethernet ports as a UTC source, select the IEEE 1588/PTP time synchronization option in the device Local Settings setup.

Both Ethernet ports can be connected to the same or two different 1588 switches. The device will obtain UTC time from one of the available sources and automatically switch to the other port whenever the signal is lost for any reason.

Each port implements an ordinary PTPv2 slave clock, complying with the IEEE C37.238 power profile:

- PTP version 2.
- PTP transport over Layer 2 Ethernet (IEEE 802.3), IEEE 1588-2008, Annex F.
- Multicast addressing.
- Peer-to-peer (P2P) path delay measurement mechanism.
- Capable of working with one-step and two-step master clocks.
- Responds to peer path delay requests with two-step peer delay responses (Pdelay_Resp, Pdelay_Resp_Follow_Up).

The 1588 ports can synchronize to the PTP grandmaster clock with sub-microsecond accuracy, which can be degraded by network topology, 1588 switch accuracy, or transmission media asymmetry.

To troubleshoot connectivity issues with 1588 switches, you can monitor the PTP clock status and time accuracy via Telnet using the “ptp” command, as shown in the following picture.

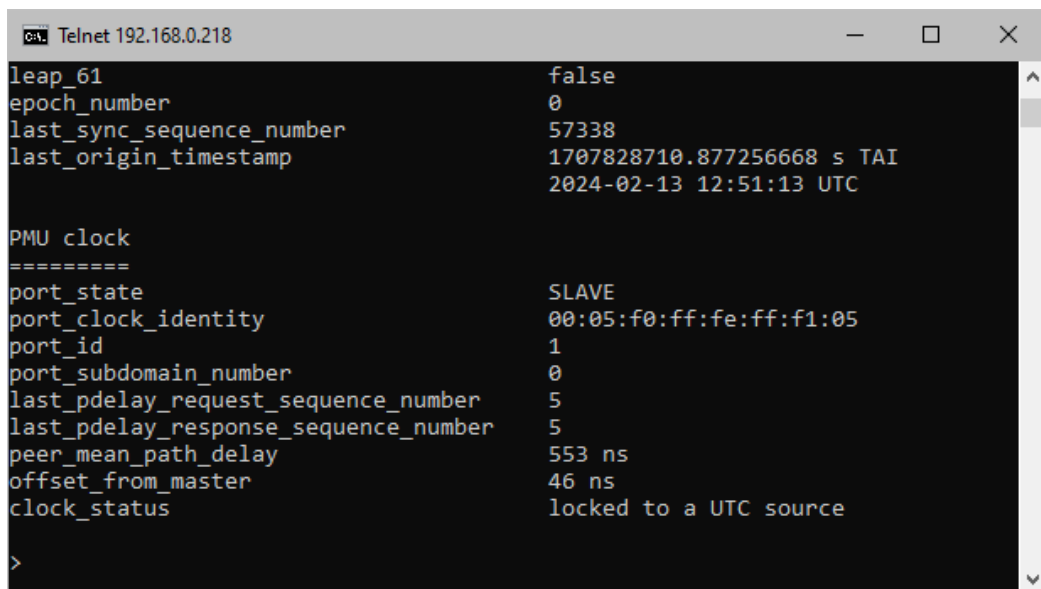

```

Telnet 192.168.0.218
leap_61                false
epoch_number          0
last_sync_sequence_number 57338
last_origin_timestamp 1707828710.877256668 s TAI
                      2024-02-13 12:51:13 UTC

PMU clock
=====
port_state             SLAVE
port_clock_identity    00:05:f0:ff:fe:ff:f1:05
port_id                1
port_subdomain_number 0
last_pdelay_request_sequence_number 5
last_pdelay_response_sequence_number 5
peer_mean_path_delay   553 ns
offset_from_master     46 ns
clock_status           locked to a UTC source
>

```

3.5 Synchrophasor Measurements

3.5.1 Synchrophasor Estimation

The PMU calculates and reports synchrophasor estimates as defined and described in IEEE C37.118.1 Clause 4.

Phasor estimates include three-phase voltage and current phasors, as well as positive and negative sequence voltage and current phasors, calculated from input waveforms synchronized to an absolute time reference.

All measurements are made on a common time base and related to the system nominal frequency, so the phase angle measurements are directly comparable. Differences in the actual frequency are included in the phase angle estimation

3.5.2 Frequency and ROCOF Estimation

The frequency is computed as the first derivative of the synchrophasor phase angle, and ROCOF is computed as the second derivative of the phase angle.

The frequency and ROCOF estimates are based on positive sequence synchrophasors calculated using the symmetrical components transformation. Since phase angle changes relative to the difference between the actual frequency and the nominal frequency, this approach yields the offset from nominal.

3.5.3 Reporting Rates

The PMU provides data measurement and reporting at sub-multiples or multiples of the nominal system frequency. The actual reporting rate is configurable through the basic device setup or through the IEEE C37.118.2 or IEC 61850 SV publisher settings.

Reporting rates at 50 Hz system frequency:

Frames/s	1	2	5	10	25	50	100	200
----------	---	---	---	----	----	----	-----	-----

Reporting rates at 60 Hz system frequency:

Frames/s	1	2	3	4	5	6	10	12	15	20	30	60	120	240
----------	---	---	---	---	---	---	----	----	----	----	----	----	-----	-----

3.6 Instrumentation Measurements

Instrumentation measurements provide real-time measurements and one-second aggregation of voltage, current, per-phase and total power and displacement power factor, and voltage and current sequence components including voltage and current unbalance.

All electrical quantities are fundamental components and are based on voltage and current synchrophasor measurements synchronized to the device's reporting rate.

See Appendix C for a full list of the measurements provided by the PMU.

3.7 Instrument Transformer Correction

Ratio and phase angle error correction can be applied to external CTs and PTs to achieve overall metering installation accuracy, or be used in any installation to optimize the accuracy of the measurement data.

The user can configure the ratio correction factor and phase angle error covering the typical transformer operating range. See 5.2.2 "Transformer Correction" for information on how to set up ratio and phase angle error correction in your device.

3.8 Operating Logic Controller

The PMU logic controller can perform various actions in response to user-defined internal and external events. Unlike a conventional PLC, the PMU uses a simplified setpoint-based programming technique that allows you to define a logical expression based on measured analog or digital values and perform the actions you want when the operate conditions are met.

The logic controller provides 32 setpoints with programmable operate and release delays, each of which evaluates a conditional expression with up to 8 arguments.

Whenever the expression evaluates to true, the logic controller can perform up to 4 user-programmable actions, including data recording on a periodic basis at programmable rate and on any internal or external trigger.

See 5.2.10 “Configuring the Logic Controller” to learn how to configure the logic controller for your application.

3.9 Operating Device I/O

3.9.1 Operating Digital Inputs

The PMU can monitor up to 25 digital inputs including one built-in digital input and others located on 3 expansion modules.

See 2.3 “Electrical Installation” for the connection diagrams and location of the digital input terminals.

All digital inputs have a programmable de-bounce time and can operate in static and pulse mode using normal (normally open) or inverting (normally closed) polarity. All inputs are sampled at a 1 ms rate.

See 5.2.5 “Configuring Digital Inputs” for information on how to configure the operation of the digital inputs in your device.

3.9.2 Operating Relay Outputs

Up to 13 relay outputs including one built-in relay and others located on 3 expansion modules can be provided with the PMU for control and alarm indication.

See 2.3 “Electrical Installation” for the connection diagrams and location of the relay terminals. See Technical Specifications in Appendix A for relay ratings.

The relay outputs are updated at a half-cycle rate. Each relay is independently programmable and can operate in latched, unlatched, pulse or KYZ mode, and relay operations can be inverted so that the relay is energized when inactive and de-energized when activated.

The relays can be operated either locally via the logic controller or by a remote command sent through communications.

See 5.2.6 “Configuring Relay Outputs” for how to configure relay outputs in your device.

3.9.3 Operating Analog Input

The PMU is equipped with one built-in optically isolated analog input with user-selectable options for 0-20 mA, 4-20 mA, 0-1 mA, and ± 1 mA. The 0-1mA and ± 1 mA inputs provide double overload up to 2 mA.

See 2.3.4 “Built-in I/O Connection” for the connection diagram and location of the analog input terminals. See Technical Specifications in Appendix A for analog input ratings.

Updating the analog input is synchronized with the PMU reporting rate. The device automatically converts the raw analog input readings received from the A/D converter to a user-defined engineering scale and reports the input values in engineering units with configurable resolution.

See 5.2.7 “Configuring Analog Input” for information on how to set up the analog input in your device.

3.10 Operating Recorders

The PMU recorders provide recording events and data to the built-in eMMC flash memory. Each log file can contain up to 65535 records. The behavior of a file when it is full can be chosen from two options: recording stops until the file is cleared (non-wrap mode), or recording continues over old records (wrap-around mode).

See 5.4.1 “Configuring Log Files” for information on configuring file size and behavior.

3.10.1 Operating the Event Recorder

The event recorder automatically records time-tagged self-supervision events related to configuration changes, resets, and device diagnostics.

It can also record logic controller operations configured for triggering the event recorder.

See 7.4 “Retrieving and Storing Files” for information on how to retrieve the event log file from your device.

3.10.2 Operating the Data Recorder

The PMU provides eight programmable data recorders for recording data on a periodic basis and on any internal or external trigger. The recording is triggered via the logic controller.

Each data log file can be configured to record up to 16 selectable parameters per record and up to 65535 records per file.

See 5.4.2 “Configuring the Data Recorder” for information on setting up data recorders in the PMU.

See 7.4 “Retrieving and Storing Files” for information on how to retrieve data files from your device.

3.11 Communicating with the PMU

See 2.3.7 “Communication Connections” for connection diagrams. See 5.3 “Configuring Communication” to learn how to change the factory-set communication settings in your device.

3.11.1 Internet Communications

The PMU provides Internet communications for a wide range of communication protocols used in industrial networks for real-time distributed control.

Assigning IP Addresses

You can assign IP addresses to your device’s Ethernet ports manually or allow IP addresses to be assigned dynamically by the network’s DHCP server on lease.

Use DHCP assigned addresses with caution because the leased IP address you are using may no longer be valid if the device has been disconnected from the network for a long

time. If PAS is unable to reconnect to your device, check the device's current IP address either through the front display or through PAS using a different communication port

Port Numbers

The PMU uses the standard TCP and UDP port numbers assigned to the corresponding protocols by the Internet Assigned Numbers Authority (IANA) by default. For some protocols, such as DNP3 and IEEE C37.118.2, you can change the default port number through the protocol configuration.

TCP Communications

Keepalive Probes

The PMU uses TCP keepalive probes to detect dead connections and prevent resource leaks. If the connection is idle longer than configured, the device sends a keepalive request to check if the connection is alive. If no response is received after 5 successive keepalive retransmissions, the connection is considered dead and will be closed.

The TCP keepalive idle time can be configured from 1 to 60 seconds or set to 0 to disable keepalive probes. It is set in the device to 20 seconds by default.

Client Connection Timeout

The client connection idle timeout can be used to terminate a connection if it has been inactive for too long. It can be configured from 1 to 300 seconds or set to 0 to disable the client idle timeout. It is set in the device to 120 seconds by default.

If the idle timeout is enabled, then the master station should periodically send probe requests to the device to maintain some kind of activity on the connection socket if it wants to keep the connection open.

When sending unsolicited messages via IEC 60870-5-104 or streaming data via IEEE C37.118.2, the device disables the connection timeout and uses keepalives regardless of port settings.

NOTE: To prevent resource leaks, the PMU does not allow both the keepalive probes and connection timeout to be disabled. At least one of the dead connection preventers will always be active.

UDP Communications

Unlike TCP connections, streaming data via UDP does not provide tools for probing whether a client who initiated transmission is still alive and listening to the data stream.

Abnormal termination of client operations without explicitly disabling data transfer may leave the stream socket active and thus cause a resource leak. To avoid this, the device provides, where necessary, the appropriate means to manually stop active UDP streams and release the associated resources.

3.11.2 Telnet Communications

The PMU comes with a Telnet server that can be used to monitor or check the current status and operations of the device. Run a "telnet" command with your device's IP address, log into the device with your user password and enter a command from the suggested list.

If Windows does not recognize the “telnet” command, go to the Start menu, select “Settings”, click “System”, and then select “Optional features”. Click “More Windows features” in the top right, check the Telnet client checkbox, and click OK.

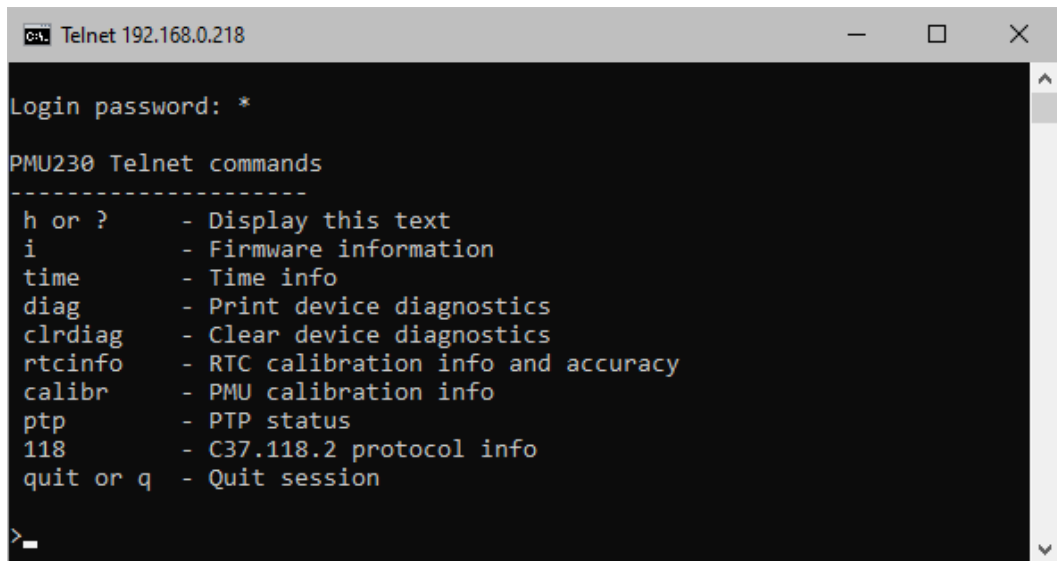

```

Telnet 192.168.0.218
Login password: *
PMU230 Telnet commands
-----
h or ?   - Display this text
i        - Firmware information
time     - Time info
diag     - Print device diagnostics
clrdiag  - Clear device diagnostics
rtcinfo  - RTC calibration info and accuracy
calibr   - PMU calibration info
ptp      - PTP status
118      - C37.118.2 protocol info
quit or q - Quit session
>

```

NOTE

Telnet access requires at least level 2 password authorization. After three unsuccessful login attempts, the Telnet server will be shut down for one minute.

3.11.3 Modbus Communications

For detailed information about Modbus protocol implementation, register map and protocol parameter settings, see the PMU Modbus Reference Guide.

Modbus protocol is used as a default communication protocol for communicating with the PMU via PAS, remote configuring and monitoring the device, and retrieving event and data log files.

The Modbus TCP server uses the standard port number 502 assigned by IANA.

Modbus TCP Notification Client

The TCP notification client can establish connections with a remote Modbus/TCP server and send notification messages either on events, or periodically on a time basis.

Client connections are triggered via the logic controller.

See 5.3.3 “Configuring the TCP Notification Client” for how to configure the TCP notification client for your application.

eXpertPower™ Client

The eXpertPower™ client provides communication with the eXpertPower™ server – SATEC’s proprietary Internet services. Connections to the eXpertPower™ server are carried out via the Modbus/TCP protocol on a periodic basis managed by the eXpertPower™ server.

See 5.3.4 “Configuring the eXpertPower Client” for information on configuring the eXpertPower™ client in your device.

3.11.4 DNP3 Communications

For information about DNP3 protocol implementation, object reference and protocol parameter settings, see the PMU DNP3 Reference Guide.

The DNP3 TCP port number is configurable via the DNP3 setup. By default, the DNP3 TCP server uses the standard port number 20000 assigned by IANA.

The PMU implements Level 2 of the DNP3 communication protocol. The device does not support unsolicited requests or hardware collision avoidance.

The PMU DNP3 implementation supports a wide variety of messages. The most common method of getting static object information from the device via DNP3 is issuing a read Class 0 request. The device allows free configuring the Class 0 response by assigning ranges of static points to be polled via Class 0 requests.

Any static object point is allowed to be linked to an associated event object point for generating data change events to be polled via event Classes 1, 2 or 3.

Up to 64 configurable event object points are available for generating events. The event scan period is half the power frequency cycle time for binary input points, and 200 ms for analog input and binary counter points.

3.11.5 IEEE C37.118.2 Communications

For information about IEEE C37.118.2 synchrophasor data transfer protocol implementation, communication features and protocol parameter settings, see the PMU IEEE C37.118.2 Reference Guide.

IEEE C37.118.2 TCP and UDP servers listen on standard ports 4712 and 4713, respectively, which can be changed in the protocol configuration.

The PMU provides commanded unicast client-server UDP and TCP data transmission and spontaneous unicast/multicast UDP data transmission using two data streams with programmable data rates. The data stream ID number uniquely identifies each data stream.

Data Frames

Synchrophasor data frames transmit a time stamped set of measurements that include phasor estimates, frequency deviation from the nominal power line frequency or actual frequency, and the rate of change of frequency. In addition, the data frame can be expanded to contain analog data (total active, reactive and apparent power, and power factor) and digital input status information.

Phasor components can include three voltage and three current phasors, positive sequence voltage and current phasors, negative sequence voltage and current phasors, or all of them in one frame.

Complex phasor values can be sent in a rectangular coordinates format (real and imaginary) or in polar coordinates (magnitude and angle). Phasor and frequency data can be represented in 32-bit IEEE floating-point format or as 16-bit scaled integer numbers. When using the integer format, the data conversion factors are provided in IEEE C37.118.2 configuration frames.

Configuration Frames

IEEE C37.118.2 configuration frames provide information about the synchrophasor data stream in binary format. The PMU supports CFG-1, CFG-2 and CFG-3 configuration frames.

In spontaneous UDP data transmission mode, CFG-2 or CFG-3 configuration frames can be sent spontaneously without an explicit user command. When enabled, a configuration frame is sent periodically every 30 seconds.

Commanded Unicast UDP and TCP Data Transmission

Commanded unicast data transfer is controlled by commands sent by the client over a unicast TCP or UDP connection to the PMU's local TCP or UDP port, respectively.

Configuration and header frames are always sent to the IP address and port from which the corresponding command was received, while data frames are sent to the IP address and port from which the start command was sent. This does not necessarily have to be the same port.

The PMU provides up to 5 simultaneous unicast TCP and/or UDP connections for streaming synchrophasor data at a user-programmable data rate using one of two commanded data streams. The transmission start command should indicate the selected stream ID number.

The stream data rate must be a submultiple of the PMU reporting rate. If it is not, the device will set it to the PMU reporting rate.

Although the UDP server responds to commands from unlimited number of UDP clients and the TCP server can support more client connections, the commands to turn on data transmission on new connections after all 5 data streams have started will be ignored.

To avoid resource leaks due to dead UDP connections, the PMU provides a command the user can send to the device through the IEEE C37.118.2 configuration dialog that stops all active commanded UDP streams and releases the associated data stream slots.

You can check which data streams are currently active via Telnet using the "188" command as shown in the following picture.

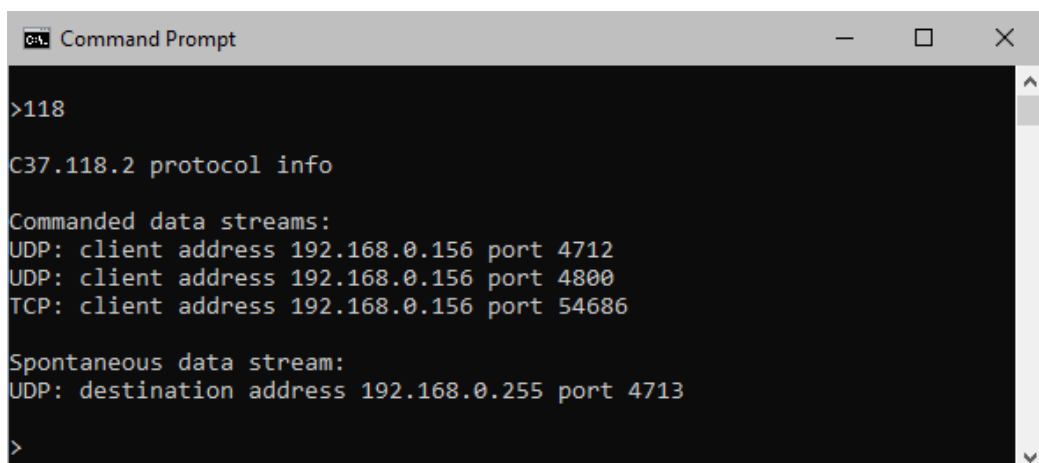

```
Command Prompt
>188
C37.118.2 protocol info
Commanded data streams:
UDP: client address 192.168.0.156 port 4712
UDP: client address 192.168.0.156 port 4800
TCP: client address 192.168.0.156 port 54686
Spontaneous data stream:
UDP: destination address 192.168.0.255 port 4713
>
```

Spontaneous UDP Data Transmission

Unlike commanded data transfer, spontaneous data frames are sent to a user-configured IP address and destination port. The PMU provides two data streams for simultaneous transmission of synchrophasor data frames to two different destinations at user-programmable data rates.

Spontaneous data transfer must be enabled or disabled explicitly by the user through the IEEE C37.118.2 settings or over an alternative client-server TCP or UDP connection to a local PMU TCP or UDP port, respectively, by referring to the appropriate spontaneous data stream identifier. Regardless of how the data stream is enabled, its state is stored in non-volatile memory, so that if it is enabled, data transfer is automatically started after the device reboots.

Configuration and header frames can be requested and received over an alternate TCP or UDP connection by referencing the appropriate data stream identifier, as in a regular client-server connection. Configuration frames can also be sent spontaneously to a user-configured destination port without an explicit command (see Configuration Frames above).

Spontaneous UDP data transmission can operate in unicast, multicast or broadcast mode depending on the destination IP address the user specified.

3.11.6 IEC 61850 Communications

For information about IEC 61850 protocol implementation, communication and protocol parameter settings, see the PMU IEC 61850 Reference Guide and PMU IEC 61850 Conformance Statement (PICS, PIXIT, MICS, TICS) documents.

The PMU IEC 61850 server supports IEC 61850-8-1 client-server and GOOSE communications and IEC 61850-9-2 sampled values communications, compliant with the IEC 61850 Ed2 set of standards.

PAS provides an IED configuration tool for customizing your device's settings and exporting IED configuration description files (CID/IID) for use with IEC 61850 client applications.

IED Configuration Description File

The IEC 61850 device data model is described in the PMU IED configuration description file "PMU_2007B_RevXX.icd" provided with your device. Use this as a basic template to create custom CID and IID files for use in your installation.

Client-server Communications

By default, the IEC 61850 TCP server uses the standard port number 102 assigned by IANA.

The TCP server supports up to 5 client-server associations simultaneously.

The IEC 61850 TCP server by default uses TCP keepalives to detect dead connections. The client connection idle timeout can optionally be used to terminate an idle connection, and is normally disabled.

GOOSE Communications

The PMU provides a GOOSE publisher for fast distribution of measurement data over Ethernet for real-time distributed control within a substation. The GOOSE publisher settings and GOOSE dataset can be configured using PAS.

GOOSE messages are continuously retransmitted across the multicast association using a configurable multicast MAC address. The fastest retransmission time is half-cycle for the first 5 messages after an event occurred, then geometric with a time multiplier of 2 until the maximum configured retransmission time.

Sampled Values Communications

The PMU provides a multicast sampled values (MSV) publisher that is responsible for streaming synchrophasor data over Ethernet. The MSV publisher settings and sampled values dataset are configurable via PAS.

Synchrophasor data transfer in the context of IEC 61850 uses IEEE C37.118 to IEC 61850 mapping mechanism defined in IEC 61850-90-5.

PMU is modeled as a dedicated logical device within the PMU IED. The detailed PMU data model is shown as part of the ICD definition file provided with your device.

IEEE C37.118.2 synchrophasor data stream is mapped to IEC 61850-9-2 sampled values APDU and the data rate is synchronized with the C37.118.2 synchrophasor data rate.

The sampled values messages are sent at a fixed rate over a multicast association using a configurable multicast MAC address.

3.11.7 IEC 60870 Communications

For information about IEC 60870-5-101 and IEC 60870-5-104 protocol implementation, communication options, object reference and protocol parameter settings, see the PMU IEC 60870-5-101/104 Reference Guide.

The PMU supports all standard ASDU types for data interrogation, event reporting and control.

TCP IEC 60870-5-104 Connections

The IEC 60870-5-104 TCP server uses the standard IANA assigned port number 2404.

Each Ethernet port can be configured for two redundant logic connections with the controlling station using two different IP addresses for spontaneous/cyclic transmission. Selecting the same IP address for both connections disables redundancy mode. In any case, both IP addresses must be defined to enable spontaneous/cyclic transmission.

Outstanding Messages

The controlling station must acknowledge receipt of information messages. The maximum number of outstanding (unacknowledged) messages allowed can be configured from 1 to 32. The default value is 12. When the number of unacknowledged messages reaches the maximum, the device pauses transmission until the controlling station sends an acknowledgement or restarts data transfer.

Interrogation

The PMU supports general and group interrogation commands for binary and analog objects. Address ranges for general and group interrogation are configurable.

Up to 15 groups can be arranged for group interrogation. Any compatible ASDU data type can be separately selected for each range of points regardless of the configured default object type.

Cyclic Data Transmission

The object address range and transmission period for periodic/cyclic data transmission are configurable. The cyclic transmission period can be set from 100 to 30,000 ms, or set to 0 (default) to disable transmission.

Configured cyclic data is transmitted periodically over the active connection after the controlling station confirms start of data transfer.

Event Reporting

The PMU provides up to 64 configurable setpoints for reporting events when the measured value exceeds a specified threshold or changes by a certain percentage, or the status of a binary point changes. The event scan period is half the power frequency cycle time for binary objects and 200 ms for analog objects.

Collected events are transmitted spontaneously over the active connection after the controlling station confirms start of data transfer.

4 Using the Front Display

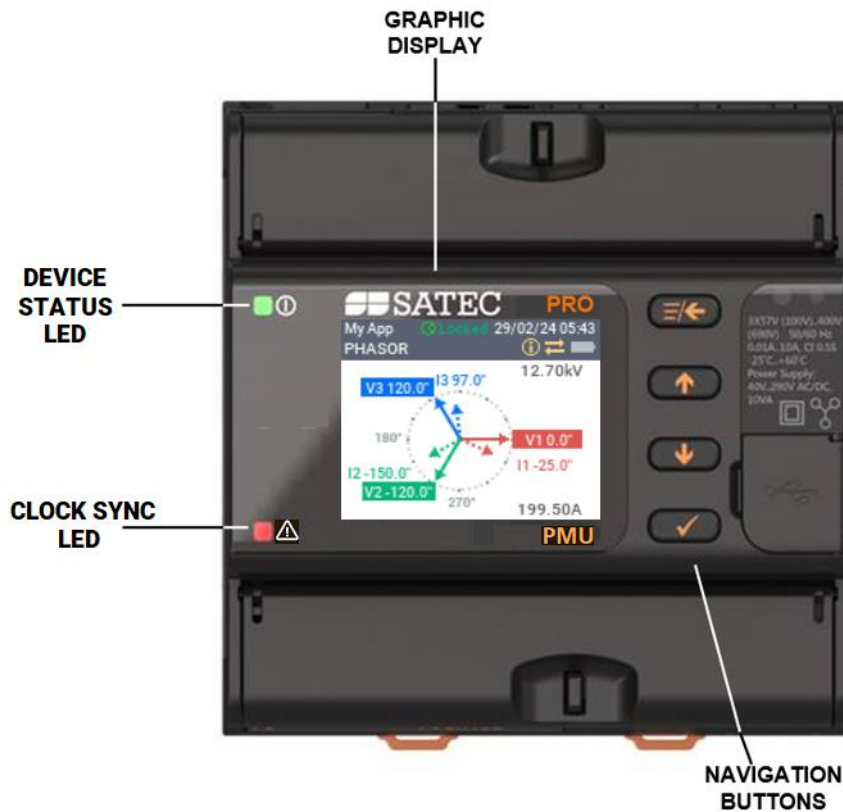

Figure 4-1 PMU Controls

4.1 Controls and Indicators

4.1.1 Status LEDs

Device Status LED

The green device status LED ⓘ flashes at 2 second intervals to indicate the operational status of the device as described in the following table.

Status	Description
Flashes once	The device is operational and works normally
Flashes twice	Device is in boot mode. This is normal when updating the device firmware. In other cases, it indicates missing or corrupted application firmware and requires user intervention to resolve the issue.
Flashes 3 times	Indicates a critical error, such as corruption of basic operating settings or a malfunction of the device clock, that requires user intervention and correction (see 3.2 “Device Diagnostics”)

Clock Sync LED

The warning LED ⚠ flashes red ones a second when the PMU clock is not synchronized with the UTC time source. The LED turns off once the clock is synced to UTC time.

4.1.2 Status Indicators

The graphic icons and messages in the display status bar provide additional indication about the status of the device.

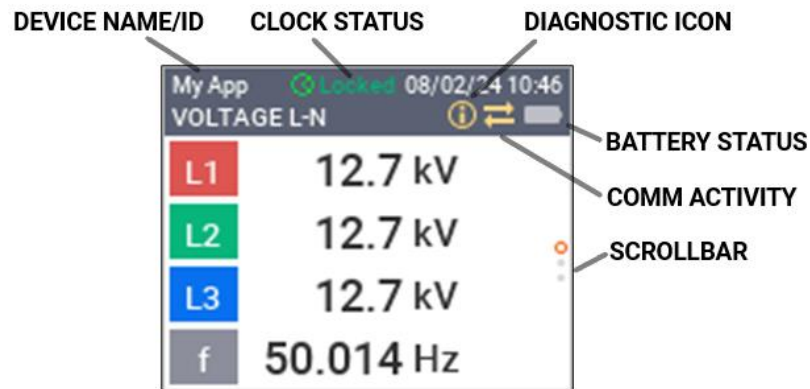

Diagnostic Icon

A diagnostic icon (i) appears in the status bar whenever diagnostic messages occur, which can be checked through the Events/Diagnostics display.

The icon will turn off once diagnostic messages are cleared, either from the display or via communication (see 3.2 “Device Diagnostics”).

Clock Sync Indicators

Clock synchronization status is indicated in the status bar with a colored message, as shown in the following table.

Message	Description
Testing	The device is trying to detect a signal from a UTC time source. When using a 1588 PTP time source, it can take up to a minute to calibrate and synchronize the device clock with the PTP master clock.
Locked	The device clock is locked to UTC time
Unlocked	The UTC time source previously synchronized to a GPS primary reference is now free-running based on its own internal oscillator. It is said to be in the holdover mode, as long as it is within its accuracy requirements.
Failure	The device has lost a signal from a UTC time source or the UTC master clock has lost a GPS signal

Battery Indicator

A black battery icon outlined by orange indicates that the lithium battery voltage is below the operating limit. The battery should be checked and replaced.

The icon will automatically return to its normal gray color once the battery voltage returns to normal.

Communication Activity Indicator

The communication activity indicator provides information about the activity of the serial and Ethernet ports and transmission direction. It is displayed in the status bar as two opposite horizontal arrows: orange when there is any data transfer occurring, and gray when there is no activity on the communication ports.

Scrollbar

In a multi-page display, a scrollbar appears on the right as a line of vertical dots and shows the number of pages available. The current page position is highlighted in orange.

4.2 Operating the Display

The PMU is equipped with a high contrast 1.77" TFT color graphics display for local data read outs, device setup and servicing. The display is normally updated once per second.

4.2.1 Display Features

The PMU display has configurable features that can be disabled, enabled or adjusted via the device Display Setup.

Brightness

The display brightness can be adjusted from 20 to 100%. By default, brightness is set to 50%.

Backlight

The duration of the display backlight can be adjusted from 1 to 10 minutes or it can be turned on continuously. By default, the backlight duration is set to 5 minutes.

If the display is dark, briefly press any button to turn the backlight on.

Auto-Return

When the auto-return option is enabled and no button is pressed for a configurable amount of time, the display automatically returns to the default screen from any other screen or menu.

The auto-return timeout can be adjusted from 1 to 30 minutes. The default value is 5 minutes.

Measurement Resolution

The display resolution for basic electrical quantities such as voltage, current and power can be adjusted from 1 to 3 decimal places for voltage and power, and from 1 to 2 decimal places for current. All measured data is displayed in primary units.

Multilanguage Support





The user can select one of the languages supported by the device. After changing the language, the device reboots.

Custom Name/ID

The user can optionally add a device name, username or ID, which will be displayed in the status bar. It can contain up to 9 alphanumeric characters.





4.2.2 Navigation Buttons

The PMU has four multi-function navigation buttons with functionality described in the following table.



Button	Function	Operation
	ESCAPE	a) In the menu: returns to the top-level menu b) In an editable field: rejects the changes made and returns to the menu c) In the measurement display: exits the currently active screen and returns to the menu
	UP	a) In the menu: highlights a menu item to select from the top or left b) In an editable field: highlights a button on the on-screen keyboard from the top or left c) In the measurement display: scrolls forward through the screens
	DOWN	a) In the menu: highlights a menu item to select from the bottom or right b) In an editable field: highlights a button on the on-screen keyboard from the bottom or right c) In the measurement display: scrolls backward through the screens
	OK/ENTER	a) In the menu: selects the highlighted menu item to display or edit b) In an editable field: confirms the changes made c) In the measurement display: adds the screen to favorites or removes it from the favorites

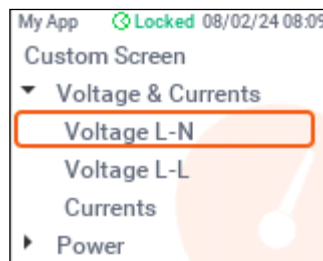

4.2.3 Menu Navigation

The device display is controlled through a multi-level menu with a hierarchical layout. Menu navigation is intuitive and does not require user experience. Whenever a non-standard action is required, a text prompt appears on the display.

Use the arrow buttons  and  to navigate to the desired menu item or entry. The selected item is highlighted or surrounded in orange. If a submenu is marked with the icon  on the left, it has a drop-down menu. Press the OK button  to open the drop-down list.



Press the OK button  to confirm your selection or enter the submenu. Press the ESCAPE button  to return to the top-level menu.

In a multi-page display, a scrollbar appears on the right as a line of vertical dots and shows the number of pages available. The current page position is highlighted in orange. Use the arrow buttons  and  to move between pages.

4.2.4 Entering Parameters

The device provides two on-screen keyboards, numeric and alphanumeric, which allow you to change device configuration parameters in the setup menus.





Entering Numeric Values

The picture below shows what the on-screen numeric keyboard looks like.

When entering a number using the on-screen keyboard, the entered character is placed at the current cursor position, which is the first blank position after the rightmost displayed character.





Shaded buttons on the keyboard indicate buttons that are currently unavailable. If the parameter can be a negative number, then the minus sign becomes available when the cursor is in the leftmost position.

To clear the rightmost digit or the entire number, use the arrow buttons  and  to highlight the “Backspace” button  on the keyboard, then press the OK button  as many times as necessary.

To enter a number, use the arrow buttons to highlight the digit you want to enter, and then press the OK button . Enter the following digits in the same way.

Once the complete number has been entered, highlight the “APPLY” button on the keyboard and press the OK button  to confirm the changes.



Your input is checked for consistency and will not be accepted if the value is outside the acceptable range. If pressing  has no effect, then the entered value is incorrect. See “Setting Up the PMU” in Chapter 5 to determine the valid range of the parameter you want to change.

To discard your changes and return to the menu, press the ESCAPE button .



Entering Text Strings



The picture below shows what the on-screen alphanumeric keyboard looks like.

Text strings are entered in the same way as numbers (see above), with a choice of uppercase and lowercase letters.

To enter a text string, use the arrow buttons  and  to highlight the letter button on the keyboard that contains the letter you want to enter, and then press the OK button  as many times as necessary until the letter you want appears in the correct case. Enter the following letters in the same way.







To enter a numeric character, change the on-screen keyboard to a numeric one by highlighting the “123” button and pressing the OK button . To return to the alphanumeric keyboard, highlight the “ABC” button and press the OK button .

Once the complete text has been entered, highlight the “APPLY” button on the keyboard and press the OK button  to confirm the changes. To discard your changes and return to the menu, press the ESCAPE button .

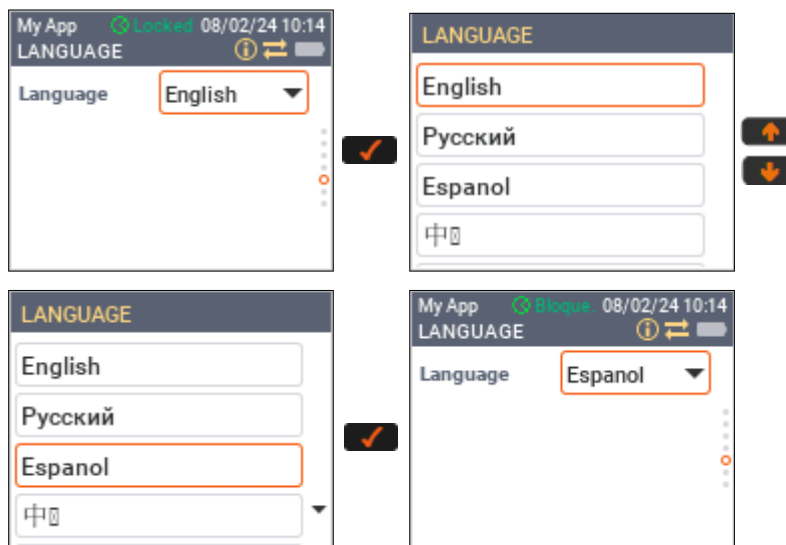
Entering Enumerated Values

If the selected parameter is an enumeration, it appears in a drop-down list, as shown in the following picture.



Use the arrow buttons  and  to highlight the parameter and press the OK button  to open the drop-down list. Select the value you want using the arrow buttons, and then press the OK button .

4.3 Display Menus

4.3.1 Main Menu

The main device menu is shown in the following picture. If you are in another screen, press the ESCAPE button  as many times as necessary until you return to the main menu.

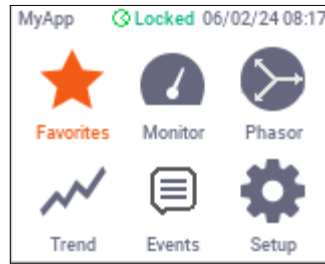

The following table explains the contents of the menus.

Display Menu	Menu Icon	Display Contents
Favorites		Predefined user favorite screens
Monitor		Electrical measurements, device identification, communication settings, device clock and I/O status
Phasor		Real-time phasor graph
Trend		Real-time voltage, current, power and frequency trend graph
Events		Device event log and diagnostic events
Setup		Device configuration setup and control

4.3.2 Favorites Menu

The Favorites menu lists the user-selected screens to display. If the Favorites menu is empty, the following message appears when you enter the Favorites menu.

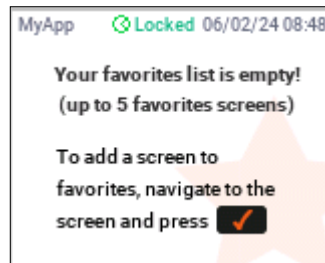

The Favorites menu can contain up to 5 entries with screens that can be selected from any other menu.

To add a new screen to your Favorites menu, navigate to the screen that you want to place in the menu and that is not already listed in the menu, press the OK button [OK button], and then confirm your choice, as shown in the following picture.

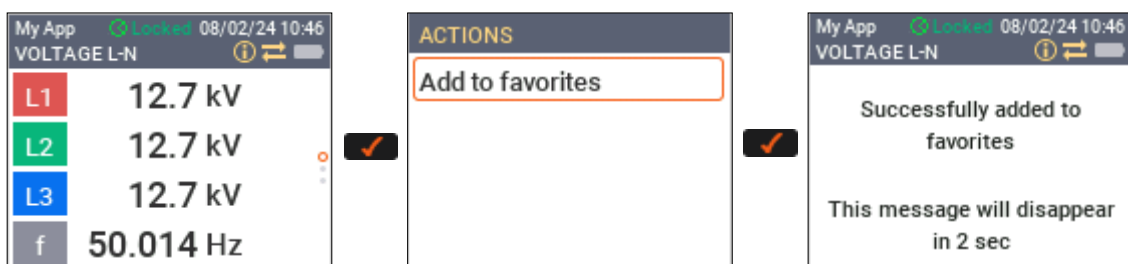

To remove a screen from the Favorites menu, navigate to the screen listed in the menu, press the OK button , and then confirm the changes.

4.3.3 Monitor Menus

The monitor menu lists screens that display current electrical measurements and device status information.

All electrical measurements are one-second averages derived from the voltage and current synchrophasor vectors and synchronized with the UTC second rollover.

The following table shows the monitor menu layout.

Main Menu	Submenu	Drop-down Menu
 Monitor	Custom Screen	
	▼ Voltage & Currents	Voltage L-N
		Voltage L-L
		Currents
	▼ Power	Total
		Phase 1
		Phase 2
		Phase 3
	▼ Device I/O	Digital Inputs
		Relay Outputs
		Analog Input
	Device Counters	
	Communication	
Clock Status		
Device Info		

The following sections describe the monitor screens and show what they look like.

Default Screen

The default screen is the screen that opens when you turn on the device.

The display also automatically returns to the default screen from any other screen or menu when the auto-return option is enabled and no button is pressed for a configurable amount of time.

By default, this is the screen that displays line-to-neutral voltages. You can choose any other screen as your default screen.

The example below shows how to select the line-to-line voltage screen as your default screen. See Navigating in Setup Menus for information on navigating in setup menus.

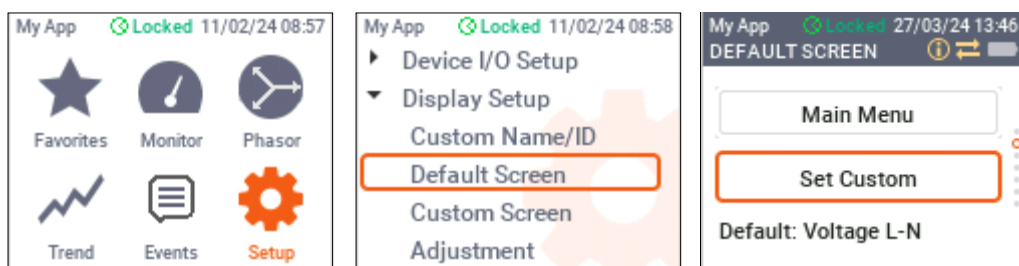

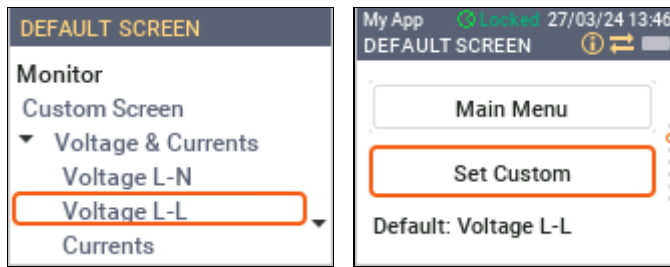

Custom Screen

The PMU allows you to build your own customized screen that will be listed in the Monitor menu and will appear like any other screen. You can also set it as your default screen.

The custom screen can contain up to 4 voltage and current readings. By default, the custom screen is blank.

The example below shows how to organize your own screen. Navigate to the Custom Screen in the Display Setup menu, press the OK button twice, and then navigate to the parameters you want to display on the custom screen and check them by pressing the OK button . Then press the ESCAPE button to return to the menu.

See Navigating in Setup Menus for more information on navigating in setup menus.

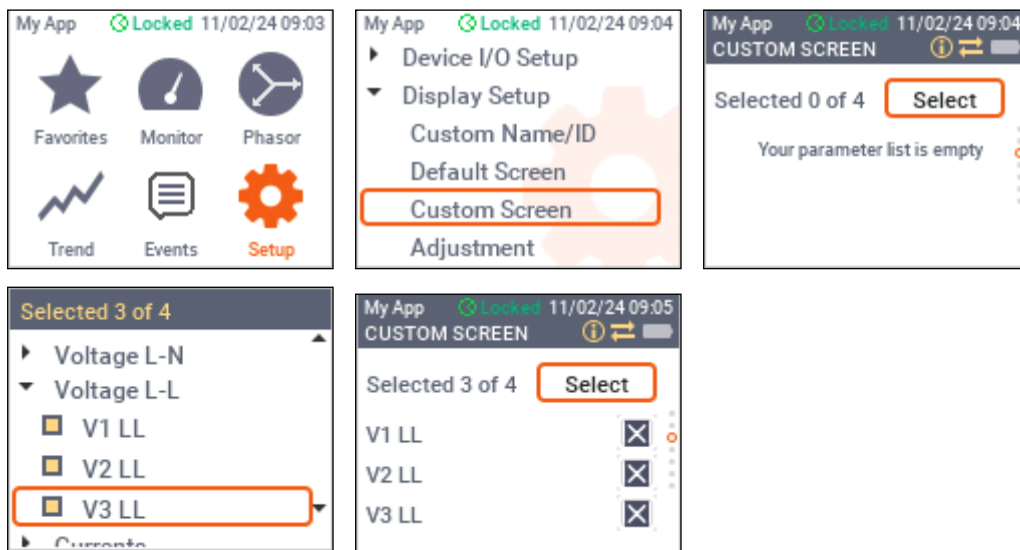

Voltage and Current Screens

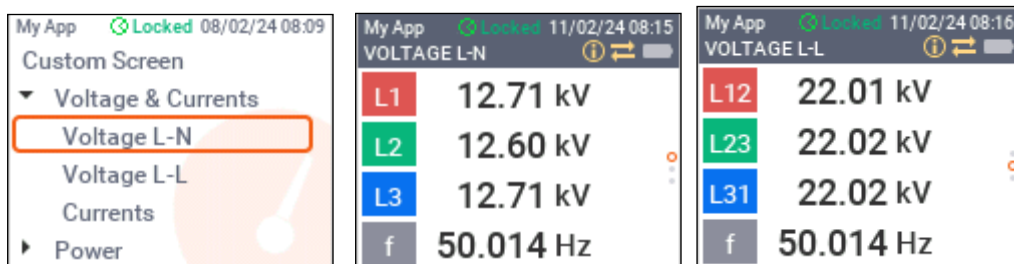

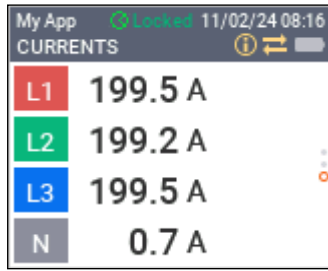

Power Screens

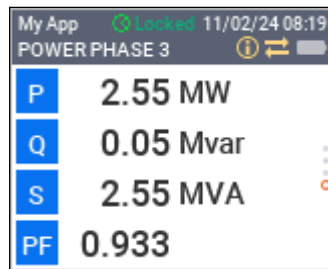
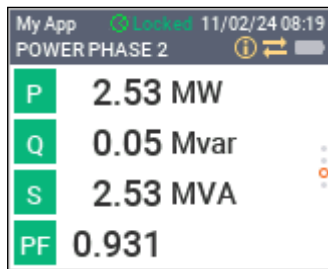
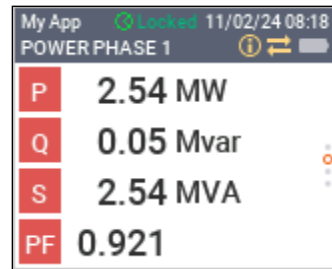
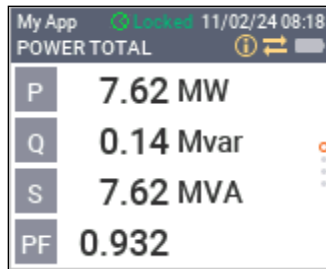
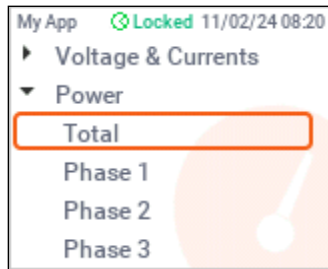

Device I/O Status

I/O status screens display the current status of the device’s digital and analog I/O.

The analog input value is indicated in engineering units according to the user-configured analog input scale.

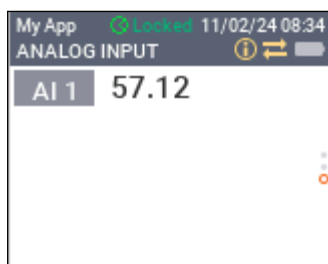
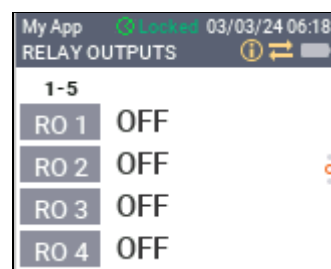
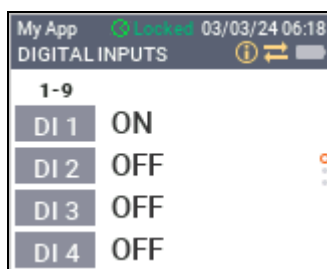
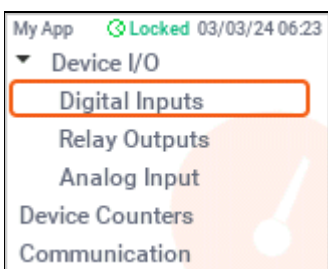

Device Counters

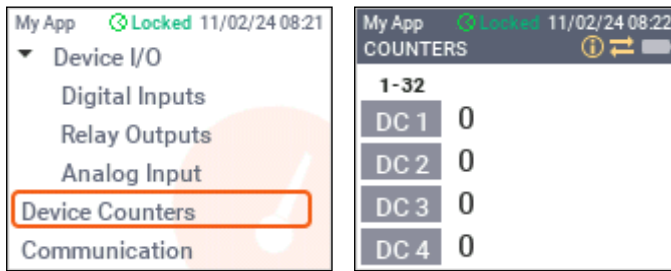

Communication Status

The communication status screen shows the activity of the communication ports. The two dots on the right flash green when data is being transferred to or from the device.

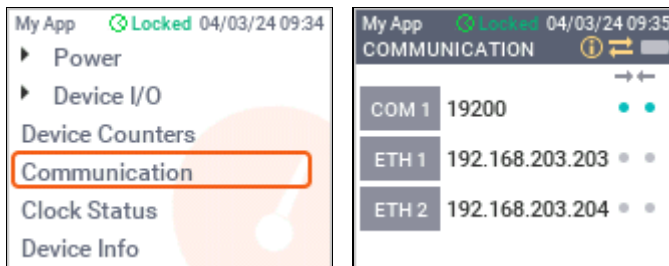

Device Clock Status

This screen provides more detailed information about the device clock synchronization and current time quality. For the IRIG-B time source, no time error is reported.

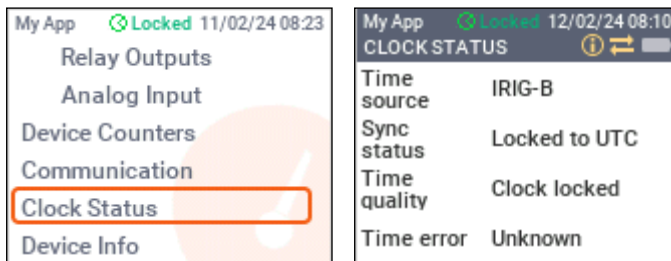

Device Information

These screens provide information about the device serial number and firmware versions, as well as detailed information about communication port settings.

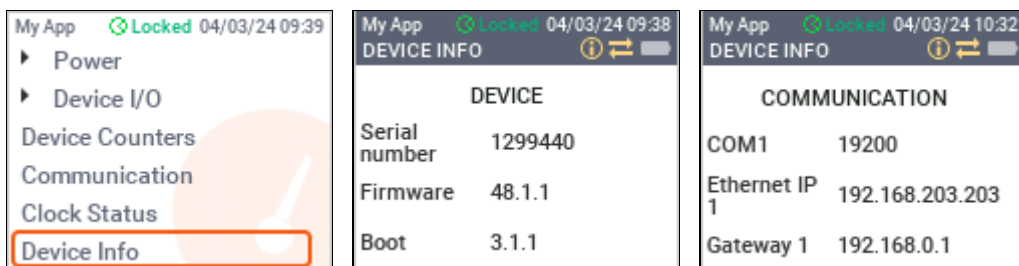

4.3.4 Phasor Diagram

The phasor diagram provides a graphical representation of the relationship between voltage and current phasors. It can be used when installing the device to check whether the phase voltage and current wires are connected to the input terminals in the correct order.

The numbers on the right show the maximum measured three-phase voltage and current.

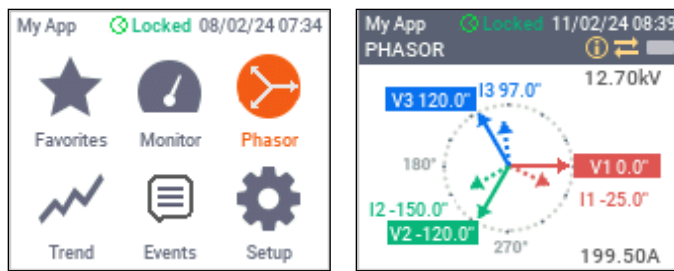

4.3.5 Trend Graph

The real-time trend graph represents the latest 10-minute measurements plotted at one-second intervals.

The device displays trends of voltage, current, total power and frequency, as shown in the following picture. The numbers below the graph indicate last measured values.

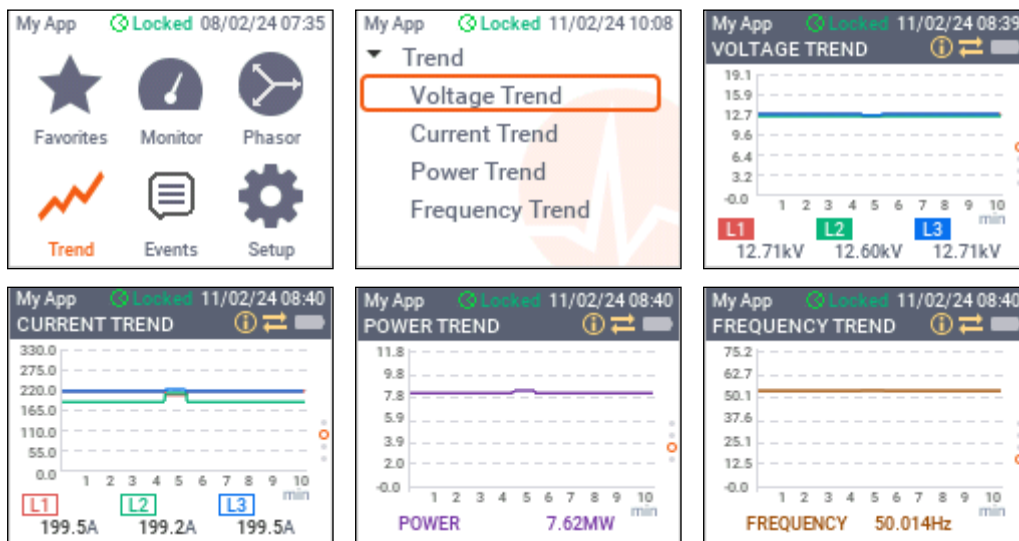

4.3.6 Events Menu

The Events menu allows you to view the device’s event log and device diagnostic messages.

Event records are listed in order from newest to oldest.

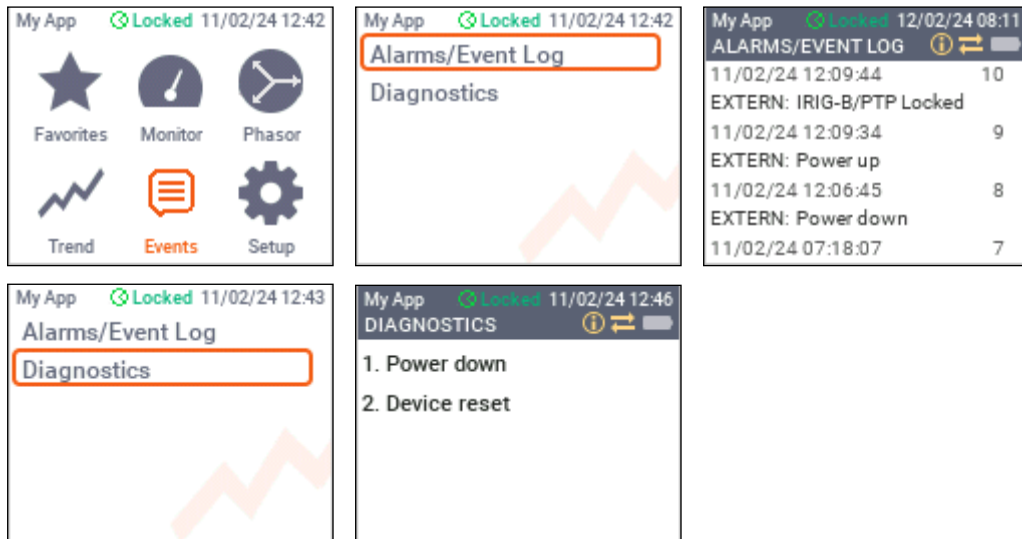

4.3.7 Setup Menus

Navigating in Setup Menus

Setup menus allow you to view or change the device configuration settings and perform certain management functions in your device.

The following table shows the setup menu layout.

Main Menu	Submenu	Drop-down Menu
 Setup	▼ General Setup	Basic Setup
		Transformer Correction
	▼ Communication Setup	COM1
		Network 1
		Network 2
		Switch Mode
	▼ Device I/O Setup	Digital Inputs
		Relay Outputs
		Analog Input
	▼ Display Setup	Custom Name/ID
		Default Screen
		Custom Screen
		Adjustment
		Language
		Auto-return
		Resolution
	▼ Date & Time	Clock
		Localization
		DST
	▼ Reset	Counters
	Diagnostics	
	Logs	

Password authorization is required to access the setup menus. Some setups and controls will prevent you from making any changes to the device if the security level of the password you entered does not give you the appropriate access rights.

Entering the Password

When prompted for a password, enter your password as a regular numeric value (see Entering Parameters).



Once the password is set to the desired value, highlight the “APPLY” button and press the OK button.

Viewing and Changing Parameters

Configuring the device parameters is demonstrated below using an example of changing the primary current of the input current transformers.

Navigate to the General Setup menu with the arrow buttons and , press the OK button to open the drop-down menu and select the Basic Setup entry. The selected item is surrounded in orange. Press the OK button to confirm your selection.

See 4.2.4 “Entering Parameters” for information on how to change a parameter value using the on-screen keyboard.

Once the desired value has been set and confirmed, press the ESCAPE button to return to the top-level menu.

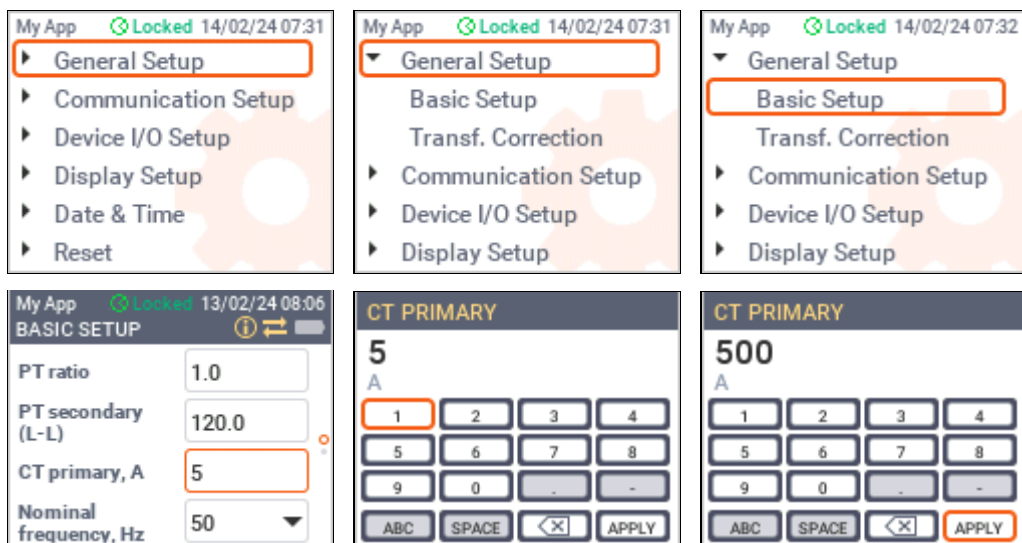

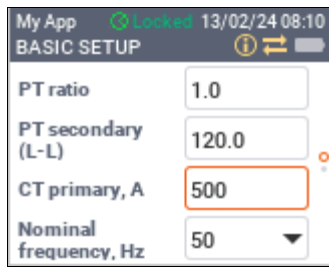

5 Setting Up the PMU

See 4.3.7 “Setup Menus” for information on how to view and modify device settings via the front display. See 7.1.4 “Configuring the Device” to learn how to work with PAS.

5.1 Authorization

Password authorization is required to access the setup menus. See 3.1 “Device Security” for information on the device password security.

Using the Front Display

See “Entering the Password” in 4.3.7 for information on entering the user password using the front display.

Using PAS

You are prompted for the password every time you try to send new configuration data or a command to the device.

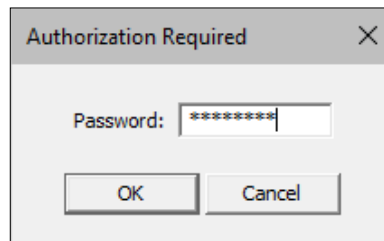

Enter the password and click OK. If your authorization was successful, you are not prompted for the password again until you close the dialog window.

5.2 General Device Settings

5.2.1 Basic Setup

These parameters provide your device with basic information about the electrical connections and device measurement options.

Using the Front Display

Navigate to the General Setup menu, press the OK button to open the drop-down menu, and then select Basic Setup. Use UP and DOWN buttons to scroll through the device settings.

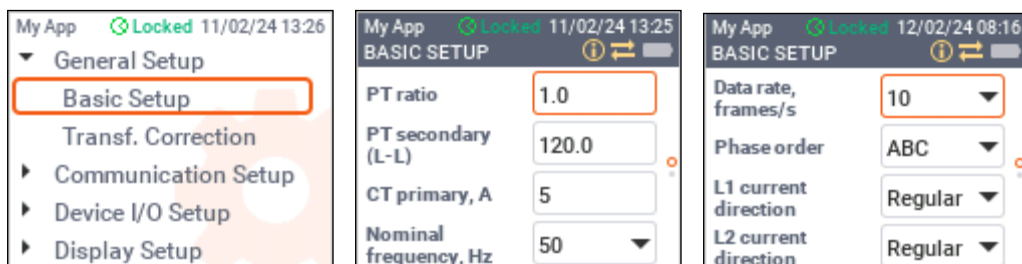

See the table below for the available options and acceptable parameter ranges.

Using PAS

Select General Setup from the Meter Setup menu and click the Basic Setup tab.

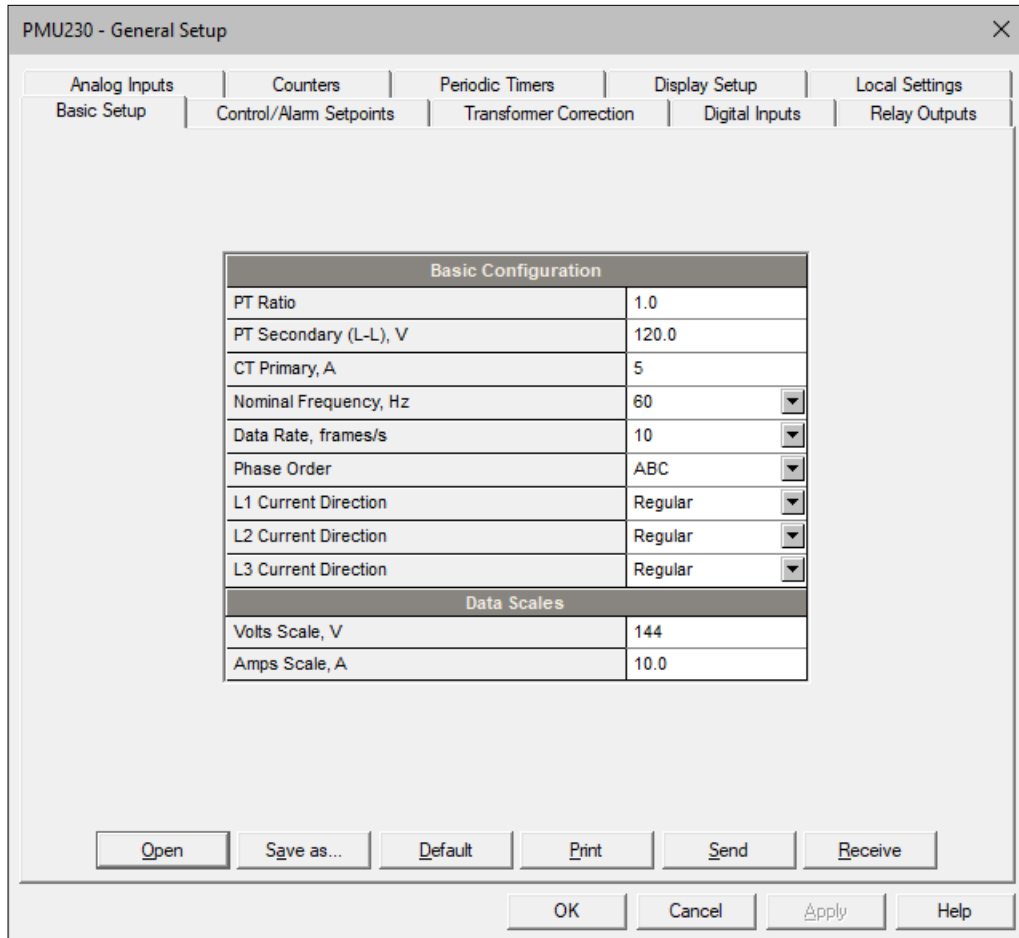

The following table lists available options.

Parameter	Options	Default	Description
PT Ratio	1.0-6500.0	1.0	The ratio of the primary and secondary windings of potential transformers (PT)
PT Secondary (L-L), V	50.0-500.0	120.0 V	Nominal secondary line-to-line voltage
CT Primary Current	1-30,000 A	5 A	Primary rating of current transformers
Nominal Frequency	50, 60 Hz	60 Hz	Nominal line frequency
Data Rate, frames/s	1,2,3,4,5,6,10,12, 15,20,25,30,50,60, 100,120,200,240	10	Data measurement rate and data reporting and transmission rate in IEEE C37.118.2 and IEC 61850 SV publisher
Phase Order	ABC, CBA	ABC	Voltage phase sequence
L1 Current Direction	Regular, Reverse	Regular	L1 current wiring direction
L2 Current Direction	Regular, Reverse	Regular	L2 current wiring direction
L3 Current Direction	Regular, Reverse	Regular	L3 current wiring direction
Volts Scale, V	60-600 V	144 V	Maximum voltage scale, in secondary volts (see Appendix D)
Amps Scale, A	1.0-20.0 A	10 A	Maximum current scale, in secondary amps (see Appendix D)

5.2.2 Transformer Correction

Transformer correction allows you to compensate ratio and phase angle inaccuracies of the voltage and current instrument transformers.

Using the Front Display

Navigate to the General Setup menu, press the OK button to open the drop-down menu, and then select Transformer Correction.

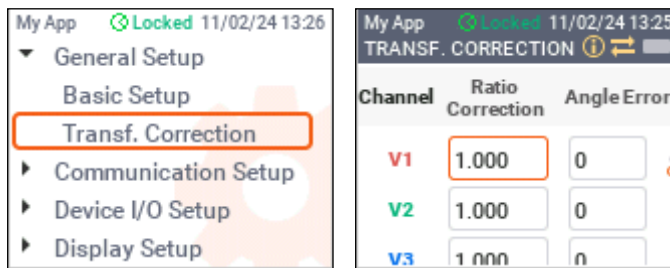

Using PAS

Select General Setup from the Meter Setup menu and click the Transformer Correction tab.

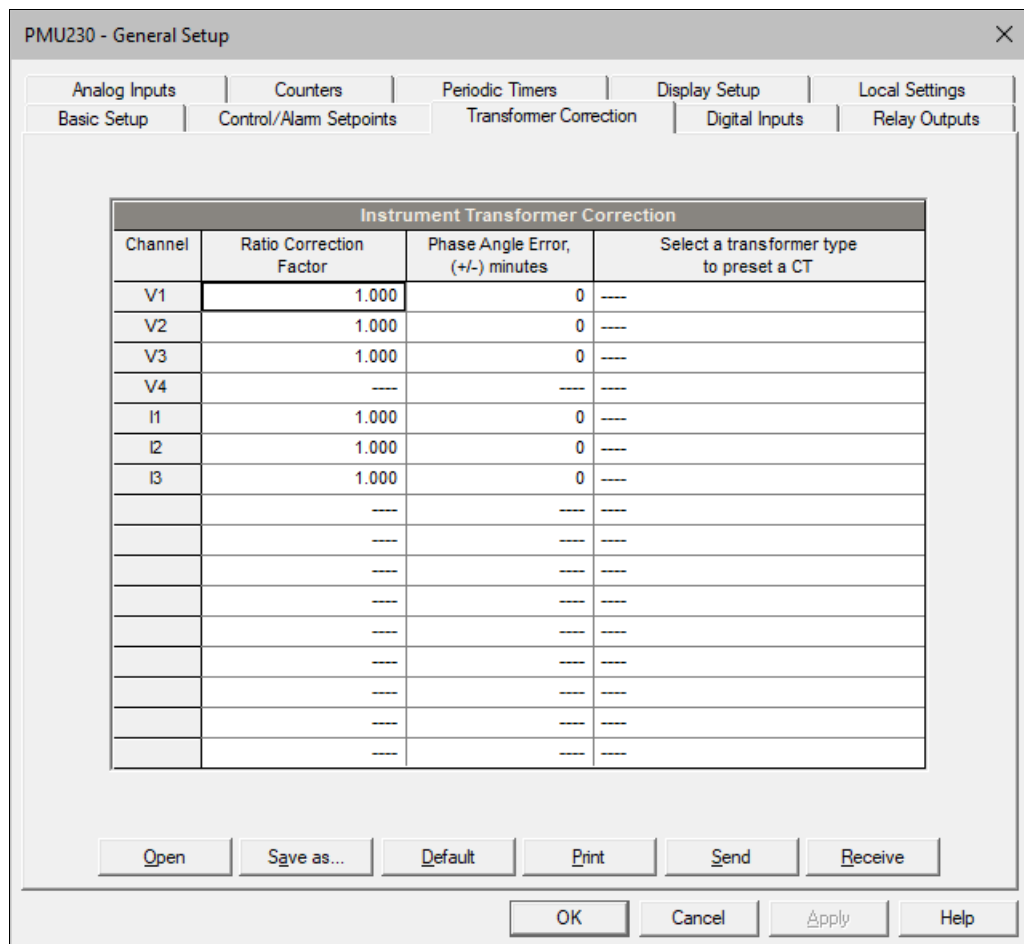

The following table lists available options.

Parameter	Options	Default	Description
Ratio Correction Factor	0.900-1.100	1.000	The ratio of the true transformer ratio to the marked ratio
Phase Angle Error	+/-600 minutes	0	The phase offset between the primary and secondary values in arc minutes. The phase angle is positive when the secondary value leads the primary value.

5.2.3 Display Setup

Using the Front Display

Navigate to the Display Setup menu, press the OK button to open the drop-down menu, and then select the entry you want.

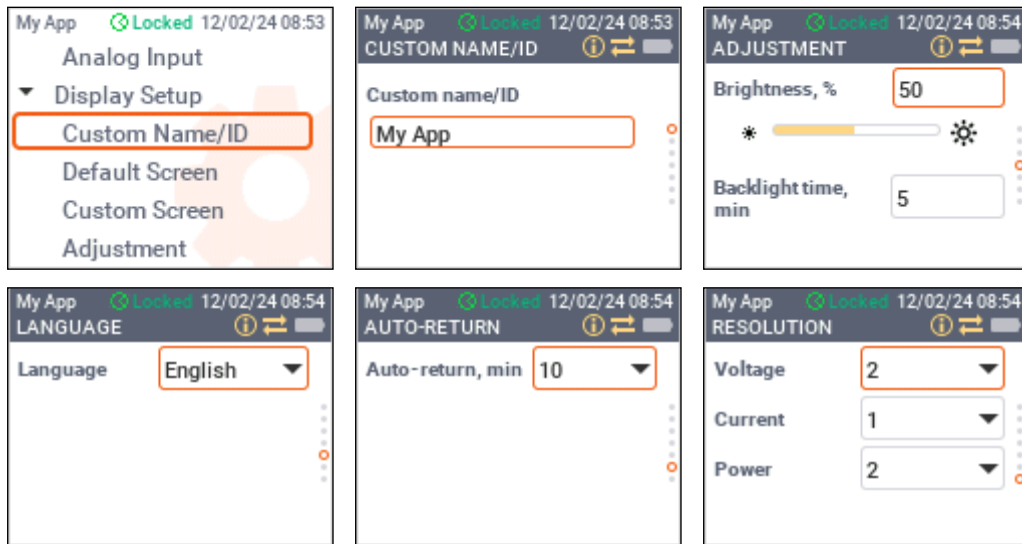

Using PAS

Select General Setup from the Meter Setup menu, and then click the Display Setup tab.

The following table lists available options.

Parameter	Options	Default	Description
Brightness	20-100 %	50 %	Display brightness
Backlight time, min	Continuous, 1-10 min	5 min	Backlight duration (see Backlight in 4.2.1)
Language	English, Spanish, Russian, Chinese	English	Display language
Volts resolution	1-3	1	Number of decimal places
Current resolution	1-2	1	Number of decimal places
Power resolution	1-3	1	Number of decimal places
Auto-return, min	Disabled, 1-5, 10, 15, 20, 25, 30 min	5 min	Auto-return timeout (see Auto-Return in 4.2.1)
Custom name/ID			Custom name or identifier shown in the display status bar (up to 9 letters)

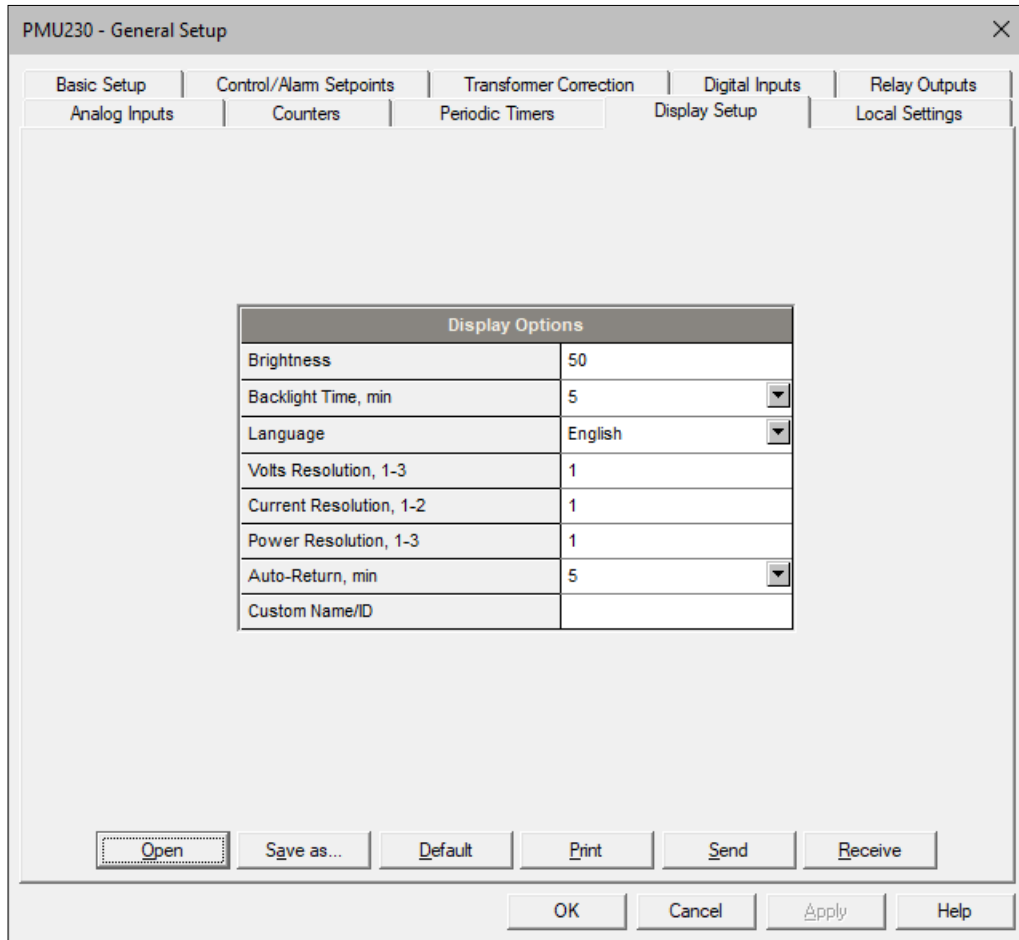

5.2.4 Device Localization

Device localization allows you to adjust your time zone’s settings, including time zone offset and daylight-saving time options, and select an external time synchronization source.

Using the Front Display

Navigate to the Date & Time menu, press the OK button to open the drop-down menu, and then select Localization. Use UP and DOWN buttons to scroll through the settings.

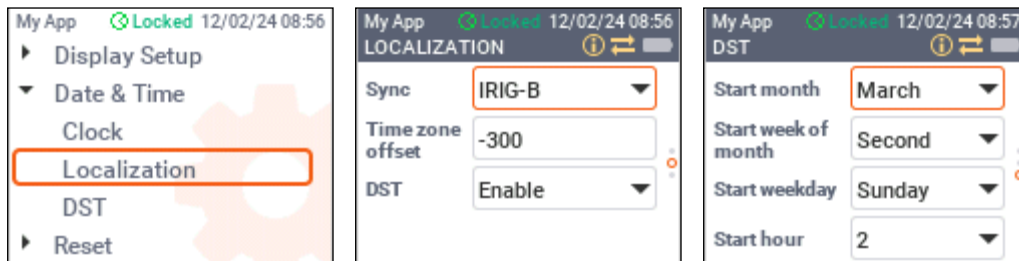

Using PAS

Select General Setup from the Meter Setup menu, and then click the Local Settings tab.

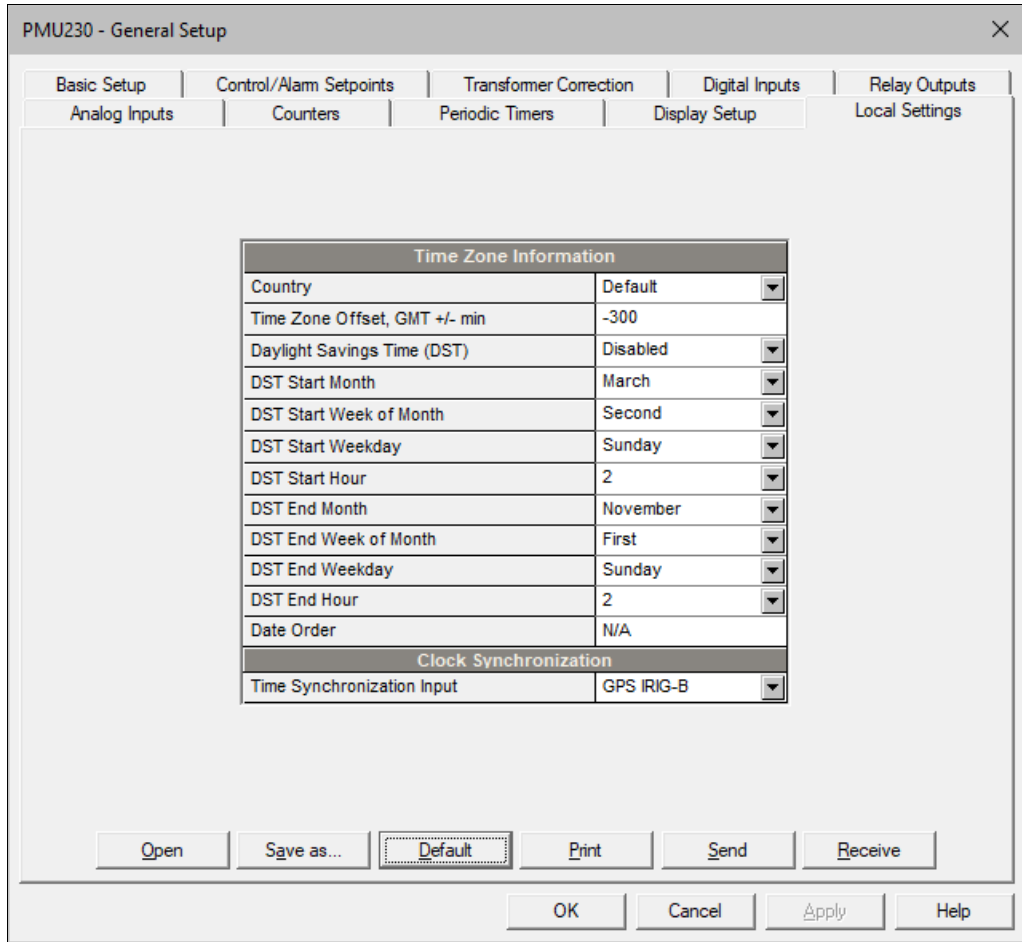

The following table lists available options.

Parameter	Options	Default	Description
Country	Country name	Default	Indicates the location of the device. The default setting stands for the U.S.A.
Time zone offset	-720 to 720 min	-300 min	Local time zone offset from UTC
Daylight saving time (DST)	Disabled Enabled	Disabled	Disabled: the clock operates in standard time. Enabled: the clock is automatically updated on daylight saving time dates
DST Start Month	January-December	March	Month when daylight saving time begins
DST Start Week	First, Second, Third, Fourth, Last	Second	Week when daylight saving time begins
DST Start Day	Sunday-Saturday	Sunday	Day when daylight saving time begins
DST Start Hour	1-6	2	Hour when daylight saving time begins
DST End Month	January-December	November	Month when daylight saving time ends
DST End Week	First, Second, Third, Fourth, Last	First	Week when daylight saving time ends
DST End Day	Sunday-Saturday	Sunday	Day when daylight saving time ends
DST End Hour	1-6	2	Hour when daylight saving time ends
Time synchronization input	IRIG-B, IEEE 1588/PTP	IRIG-B	Port receiving time sync signal

5.2.5 Configuring Digital Inputs

Using the Front Display

Navigate to the Device I/O Setup menu, press the OK button to open the drop-down menu, and then select Digital Inputs.

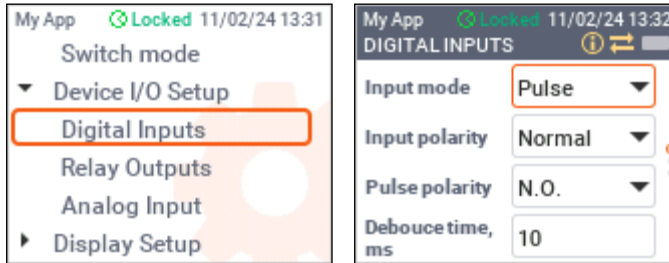

To view or configure an expansion digital input, first enter the input number.

Using PAS

Select General Setup from the Meter Setup menu and click the Digital Inputs tab.

Digital input numbers are assigned by the device in the order in which expansion modules are connected to the device. The built-in digital input is designated DI1. Digital inputs that are not present in the device do not appear in the setup dialog.

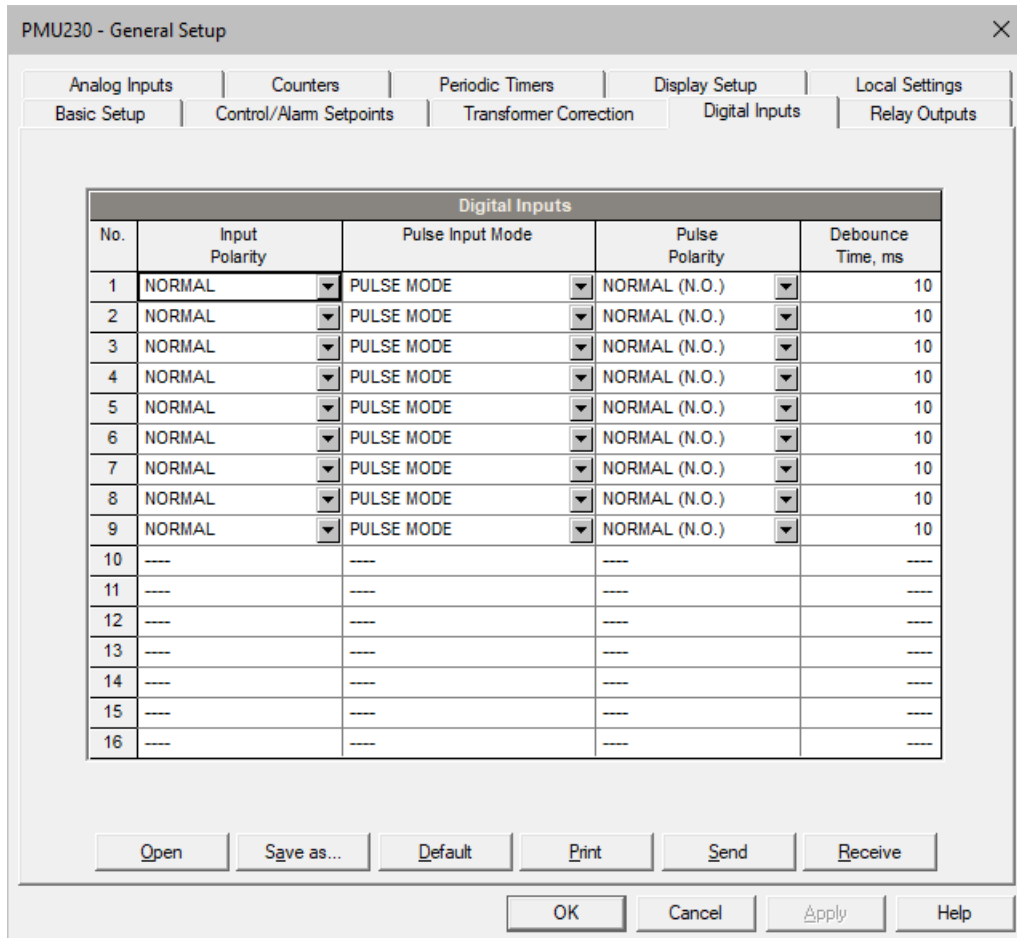

The following table lists available options.

Parameter	Options	Default	Description
Input Polarity	NORMAL INVERTING	NORMAL	Input polarity for static input
Pulse Input Mode	PULSE MODE KYZ MODE	PULSE MODE	PULSE: one of the edges, leading or trailing, is recognized as a pulse KYZ: both edges are recognized as a pulse
Pulse Polarity	NORMAL (N.O.) INVERTING (N.C.)	NORMAL	Input polarity for pulse input NORMAL: the transition from open to closed is considered a pulse INVERTING: the transition from closed to open is considered a pulse. N/A in KYZ mode
Debounce Time	1-1000 ms	10 ms	The time during which the state of a digital input must not change to be recognized as a new state

5.2.6 Configuring Relay Outputs

Using the Front Display

Navigate to the Device I/O Setup menu, press the OK button to open the drop-down menu, and then select Relay Outputs.

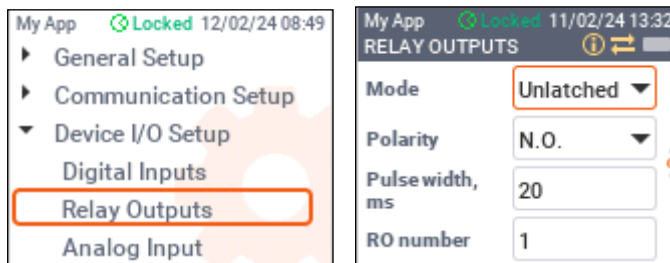

To view or configure an expansion relay output, first enter the output number.

See the table below for the available options and acceptable parameter ranges.

Using PAS

Select General Setup from the Meter Setup menu and then click the Relay Outputs tab.

Relay numbers are assigned by the device in the order in which expansion modules are connected to the device. The built-in relay output is designated RO1. Relays that are not present in the device do not appear in the setup dialog.

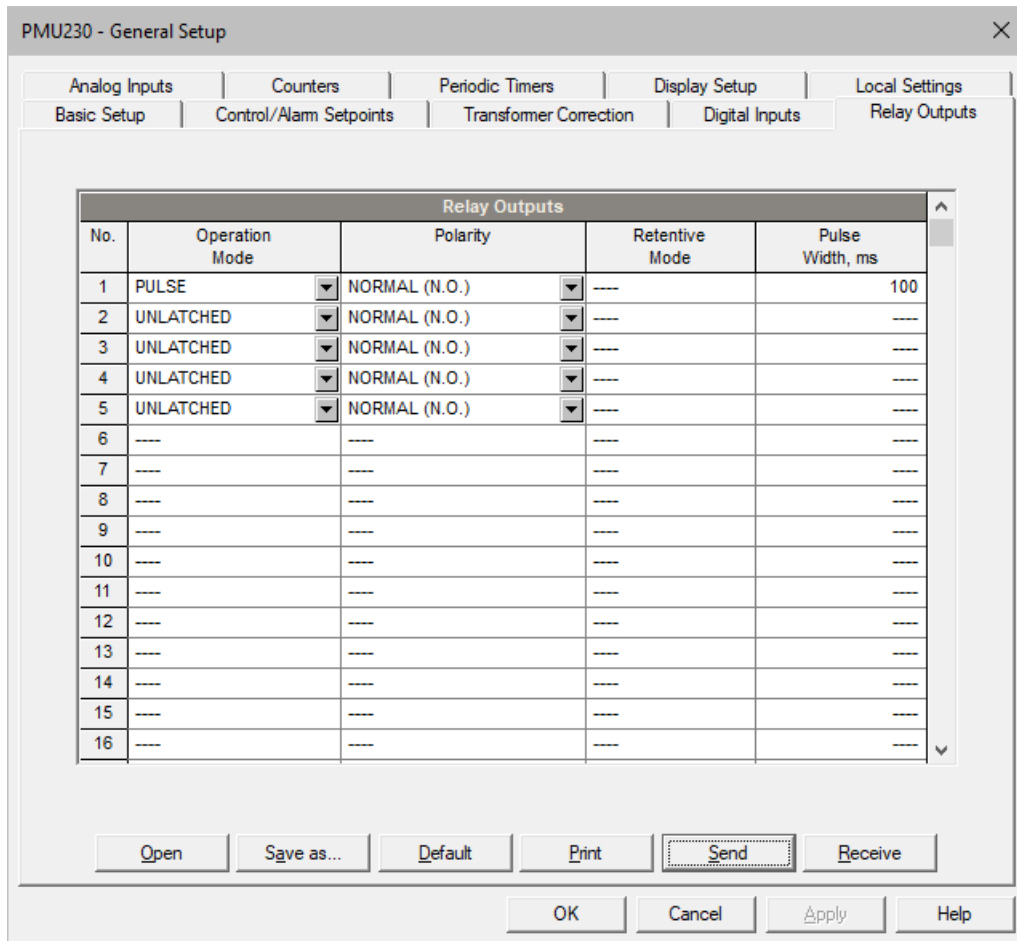

The following table lists available options.

Parameter	Options	Default	Description
Operation mode	UNLATHCED, LATCHED, PULSE, KYZ	UNLATCHED	Relay operating mode (see below)
Polarity	NORMAL (N.O.), INVERTING (N.C.)	NORMAL	NORMAL: the relay is de-energized when inactive and energized when activated INVERTING: the relay is energized when inactive and de-energized when activated
Retentive mode	NO, YES	NO	Applicable for latched relays only. NO: the relay always returns to the inactive state upon power up YES: the relay state is restored to the state it was before power loss
Pulse width	10-3000 ms	100 ms	The actual pulse width is a multiple of the half-cycle time rounded to the nearest higher value. The pause between pulses is equal to the pulse width.

The relay can operate in the following modes:

- UNLATCHED: the relay goes into the active state when the control setpoint is in the active (operated) state, and returns to the inactive state when the control setpoint is released
- LATCHED: the relay goes into the active state when the control setpoint goes to the active state and remains active until it is returned to the inactive state by a local or remote command
- PULSE: the relay goes into the active state for a specified time, goes into the inactive state for the specified time and remains in the inactive state
- KYZ: the relay output state changes with each command and remains in this state until the next command

5.2.7 Configuring Analog Input

Using the Front Display

Navigate to the Device I/O Setup menu, press the OK button to open the drop-down menu, and then select Analog Input.

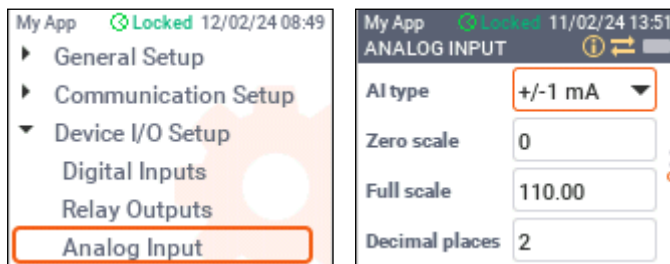

Using PAS

Select General Setup from the Meter Setup menu and click the Analog Inputs tab.

The following table lists available options.

Parameter	Options	Default	Description
AI type	± 1 mA, 0-1 mA, 0-20 mA, 4-20 mA	± 1 mA	User-selectable AI type.
Zero scale	Up to 9 digits including decimal places (\pm)	0	Low engineering scale (in primary units) corresponding to the minimum input current (0 or 4 mA)
Full scale	Up to 9 digits including decimal places (\pm)	0	High engineering scale (in primary units) corresponding to the maximum input current (2 or 20 mA)
Dec. Places	0-3	0	Number of decimal places in a fractional part of the scaled value
Value label			An arbitrary name that you can give the analog input quantity

PMU230 - General Setup

Basic Setup | Control/Alam Setpoints | Transformer Correction | Digital Inputs | Relay Outputs
 Analog Inputs | Counters | Periodic Timers | Display Setup | Local Settings

Analog Inputs					
No.	AI Type	Zero Scale (0/4mA)	Full Scale (1/20/50mA, 10V)	Dec. Places	Value Label
1	+/-1 mA	0.00	110.00	2	Aux voltage
2	----	----	----	----	----
3	----	----	----	----	----
4	----	----	----	----	----
5	----	----	----	----	----
6	----	----	----	----	----
7	----	----	----	----	----
8	----	----	----	----	----
9	----	----	----	----	----
10	----	----	----	----	----
11	----	----	----	----	----
12	----	----	----	----	----
13	----	----	----	----	----
14	----	----	----	----	----
15	----	----	----	----	----
16	----	----	----	----	----

Open Save as... Clear Print Send Receive

OK Cancel Apply Help

NOTES

1. The ± 1 mA and 1 mA inputs provide double overload and are calibrated for ± 2 mA and 2 mA input currents respectively, so you should set the high engineering scale for the 2 mA input current.
2. The engineering scale for the ± 1 mA bidirectional analog input is symmetrical around zero. Only the high engineering scale needs to be configured.
3. Analog input labels are not stored in the device. Always save the analog inputs setup to the site database in order to keep your labels.

5.2.8 Configuring Counters

The PMU has 32 nine-digit general purpose counters intended to count input pulses and events with a programmable scale factor. They can be used by the logic controller to perform repeated operations or as temporary storage.

To set up counters, select General Setup from the Meter Setup menu, and then click the Counters tab.

PMU230 - General Setup

Basic Setup | Control/Alam Setpoints | Transformer Correction | Digital Inputs | Relay Outputs
 Analog Inputs | Counters | Periodic Timers | Display Setup | Local Settings

Counter Indication	
Counter	Counter Value
1	140
2	0
3	0
4	0
5	0
6	0
7	0
8	0
9	0
10	0
11	0
12	0
13	0
14	0
15	0
16	0

Counter Source List			
No.	Pulse Source	Multiplier	Counter
1	DI1	1	#1
2	----	1	#1
3	----	1	#1
4	----	1	#1
5	----	1	#1
6	----	1	#1
7	----	1	#1
8	----	1	#1
9	----	1	#1
10	----	1	#1
11	----	1	#1
12	----	1	#1
13	----	1	#1
14	----	1	#1
15	----	1	#1
16	----	1	#1

Open Save as... Clear Print Send Receive

OK Cancel Apply Help

If you are connected to a device, the left pane displays the current contents of the counters. You can preset the counters to any value you want: enter a number in the “Counter Value” field and click Send.

To link a digital input as a pulse source to a counter, select the digital input in the “Pulse Source” field, enter the pulse multiplier, then select the counter you want to link the input to and click Send. Several digital inputs can be connected to the same counter.

5.2.9 Configuring Periodic Timers

The PMU provides 16 interval timers with programmable time periods from half-cycle to 24 hours. They are intended to be used by the logic controller for periodic recording and triggering time-based operations. Seven timers from #10 to #16 are factory preset, and others can be configured by the user.

To set up periodic timers, select General Setup from the Meter Setup menu and click the Periodic Timers tab.

To run a periodic timer, select the time units in which you define the period and specify a non-zero timer period. To stop the timer, set the timer period to zero.

PMU230 - General Setup

Basic Setup | Control/Alarm Setpoints | Transformer Correction | Digital Inputs | Relay Outputs
 Analog Inputs | Counters | Periodic Timers | Display Setup | Local Settings

Periodic Timers					
No.	Period	Units	No.	Period	Units
1	1.000	Seconds	9	0.000	Seconds
2	0.000	Seconds	10	0.500	Cycles
3	0.000	Seconds	11	1.000	Cycles
4	0.000	Seconds	12	0.200	Seconds
5	0.000	Seconds	13	3.000	Seconds
6	0.000	Seconds	14	10.000	Seconds
7	0.000	Seconds	15	600.000	Seconds
8	0.000	Seconds	16	7200.000	Seconds

Open Save as... Clear Print Send Receive

OK Cancel Apply Help

5.2.10 Configuring the Logic Controller

The logic controller provides 32 setpoints with programmable operate and release delays, each of which evaluates a conditional expression with up to 8 arguments.

Whenever the expression evaluates to true, the logic controller can perform up to 4 user-programmable actions, including data recording on a periodic basis at programmable rate and on any internal or external trigger.

The scan time for all setpoints is half-cycle time

To set up the logic controller, select General Setup from the Meter Setup menu and then click the Control/Alarm Setpoints tab.

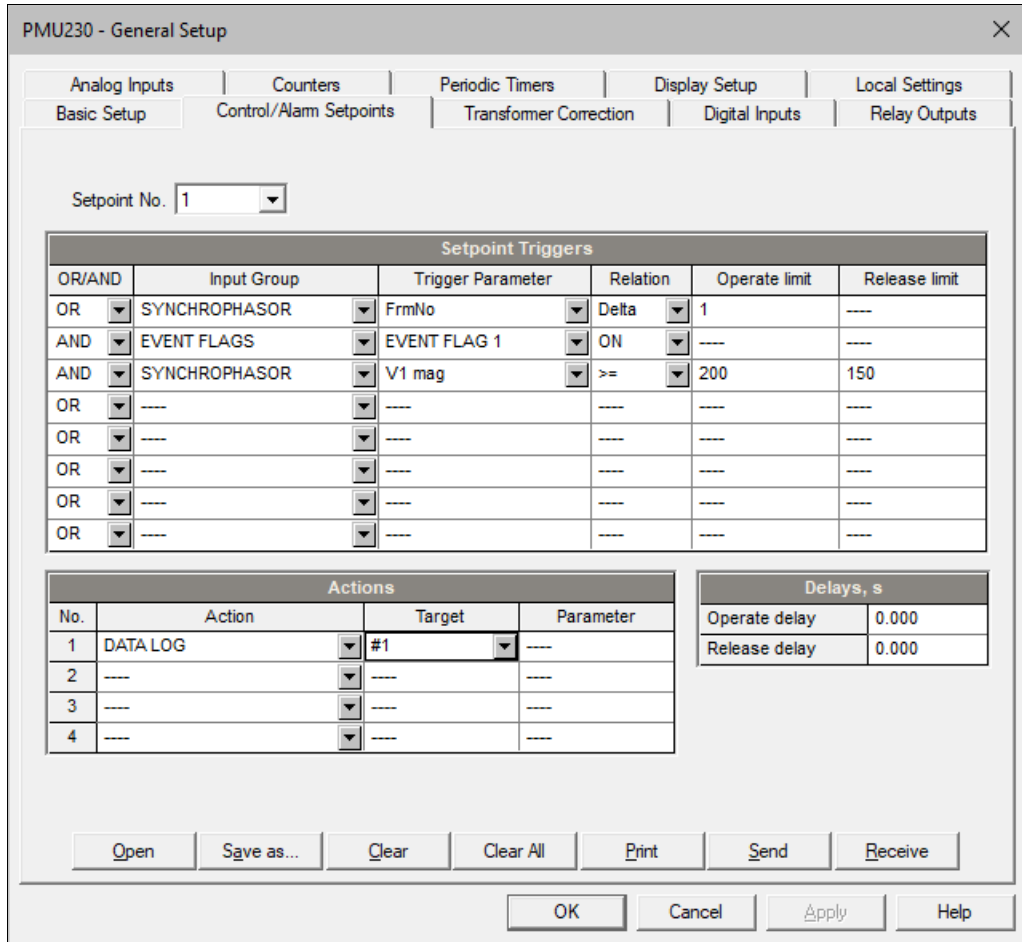

The setpoint options are described in the following table.

Parameter	Options	Description
OR/AND	OR, AND	The logical operator for the trigger
Input group	See Appendix C	The trigger parameter group
Trigger parameter	See Appendix C	The trigger parameter used as an argument in the conditional expression
Relation	<=, >=, =, <>, ON, OFF, Delta, Delta+, Delta-, rDelta, rDelta+, rDelta-	The relational operator used in the conditional expression (see explanation below on using Delta operators)
Operate limit	Trigger specific	The threshold (in primary units) at which the expression will evaluate to true. Not applicable for digital triggers.
Release limit	Trigger specific	The threshold (in primary units) at which the expression will evaluate to false. Defines the hysteresis for analog triggers. Not applicable for digital triggers.
Action	See below	Action taken when the setpoint expression evaluates to true
Target		The optional action target
Operate delay	0-1000.000 sec	Time delay before activation of the setpoint when the operate conditions are met
Release delay	0-1000.000 sec	Time delay before the setpoint is deactivated when the release conditions are met

Delta operators evaluate a logical expression to true if the following conditions are met:

- Delta: the absolute difference between the last reported value and the current value exceeds the specified threshold
- Delta+ (incremental delta): the positive difference between the current value and the last reported value exceeds the specified threshold
- Delta- (decremental delta): the positive difference between the last reported value and the current value exceeds the specified threshold
- rDelta (relative delta): the absolute difference between the last tested value and the current value exceeds the specified threshold
- rDelta+ (incremental relative delta): the positive difference between the current value and the last tested value exceeds the specified threshold
- rDelta- (decremental relative delta): the positive difference between the last tested value and the current value exceeds the specified threshold

The available setpoint actions are listed in the following table.

Action	Target	Description
-	-	None (no action)
SET EVENT FLAG	1-32	Raise an event flag
CLEAR EVENT FLAG	1-32	Drop an event flag
OPERATE RELAY	1-13	Operate relay
RELEASE RELAY	1-13	Release latched relay
INCREMENT COUNTER	1-32	Increment counter
DECREMENT COUNTER	1-32	Decrement counter
CLEAR COUNTER	1-32	Clear counter
EVENT LOG	OPER, RELS, ANY	Event log on setpoint operation, release or both
DATA LOG	1-8	Data recording to log file
SEND NOTIFICATION	-	Send a notification to a remote TCP server

Using Logical Operators

Logical operators OR/AND are treated in a simplified manner. They have no specific priority or precedence rules.

Any trigger condition that is ORed in a logical expression and evaluates to true overrides any preceding condition evaluated to false. Likewise, any trigger condition that is ANDed in a logical expression and evaluates to false overrides any condition evaluated to true before it.

To avoid confusion, it is recommended not to interleave different logical operators in one expression. Instead, combine all conditions that use the same logical operator on one side of the expression, and the others on the opposite side.

To explicitly override all preceding conditions with a critical trigger, place it at the end of the logical expression using an OR operator if you want the setpoint to be operated anyway when the trigger condition evaluates to true, and with an AND operator, if the setpoint should not be operated while the critical trigger is not asserted.

Using Numeric Triggers

For numeric (analog) triggers, a setpoint allows you to specify two thresholds for each trigger to provide hysteresis (dead band) for setpoint operations. The operate limit defines the operating threshold, and the second release limit defines the release threshold for the trigger. Trigger thresholds are always specified in primary units.

If you do not want to use hysteresis, set the release limit to the same as the operate limit.

Using Binary Triggers

Binary (digital) triggers, as digital inputs, relays, or event flags, are tested for ON (closed/set) or OFF (open/cleared) conditions.

Binary triggers are divided into two types: static and pulsed. Static events are level-sensitive and are asserted as long as the corresponding condition exists, such as event flags or static digital inputs.

Pulsed events are edge-sensitive events with auto-reset, such as pulse inputs (transition pulses on digital inputs) and events generated by interval timers. The logic controller clears pulsed events at the end of each scan, so that triggers that used these events are prevented from being triggered once again.

Using Interval Timers

Interval timers are not synchronized with the clock. When the setpoint is activated, the timer is restarted and then generates the next timer pulse when the timer interval expires.

Using Time Triggers

Unlike interval timers, time triggers are synchronized with the device clock and can be used to program time-synchronized actions, such as synchronous recording interval data.

Delaying Setpoint Operations

Two optional delays can be added to each setpoint to extend monitoring setpoint for a longer time before making a decision on whether the expected event has occurred or not. If a delay is specified, the logic controller changes the setpoint state only if all conditions are asserted for a period at least equal to the delay time.

Setpoint Actions

When a setpoint state changes, that is, the setpoint event is either activated or deactivated, the following happens in your device:

- The new setpoint status is logged to the setpoint status register that can be monitored via communications in order to give an indication of the expected event.
- The status of the activated setpoint is latched in the setpoint alarm register, which is also accessible remotely. The register retains the last setpoint alarm state until it is explicitly cleared.

- Up to four programmable actions can be performed when the setpoint is activated. Typically, setpoint actions are performed independently for each setpoint and can be repeated several times for the same target.

The exceptions are relay operations and data recording that are shared among all setpoints using an OR scheme for each target. The relay output is activated when one of the setpoints linked to the relay is activated and remains energized until all those setpoints are released.

5.3 Configuring Communication

5.3.1 Network Setup

Using the Front Display

Navigate to the Communication Setup menu, press the OK button to open the drop-down menu, and then select Network 1 or Network 2 for Ethernet port 1 and 2, respectively. Scroll through network settings using the UP and DOWN arrow buttons.

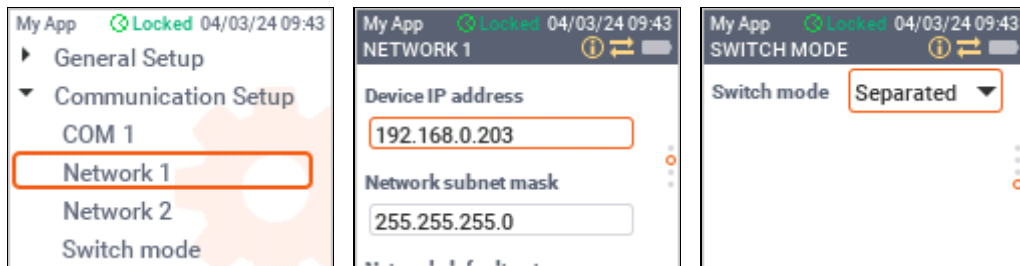

Using PAS

Select Communication Setup from the Meter Setup menu, click the Network Setup tab, and then select the network port you want to configure.

The top panel shows the currently active port settings. If you are using DHCP assigned addresses, they may differ from manually configured static network settings.

The following table lists available options.

Parameter	Options	Default	Description
Device IP Address		192.168.0.203	Static port IP address
Network Subnet Mask		255.255.255.0	Static port subnet mask
Network Default Gateway		192.168.0.1	Static default network gateway
Use DHCP	NO, YES	NO	Enables dynamic IP address assignment by a network DHCP server
Connection Idle Timeout, s	0 = disabled, 30-300 s	120 s	Client connection idle timeout (see "Client Connection Timeout" in 3.11.1)
TCP Keepalive Time, s	0 = disabled, 1-60	20 s	TCP keepalive idle time (see "Keepalive Probes" in 3.11.1)
Switch Mode	Daisy Chain, Separated	Separated	Network topology

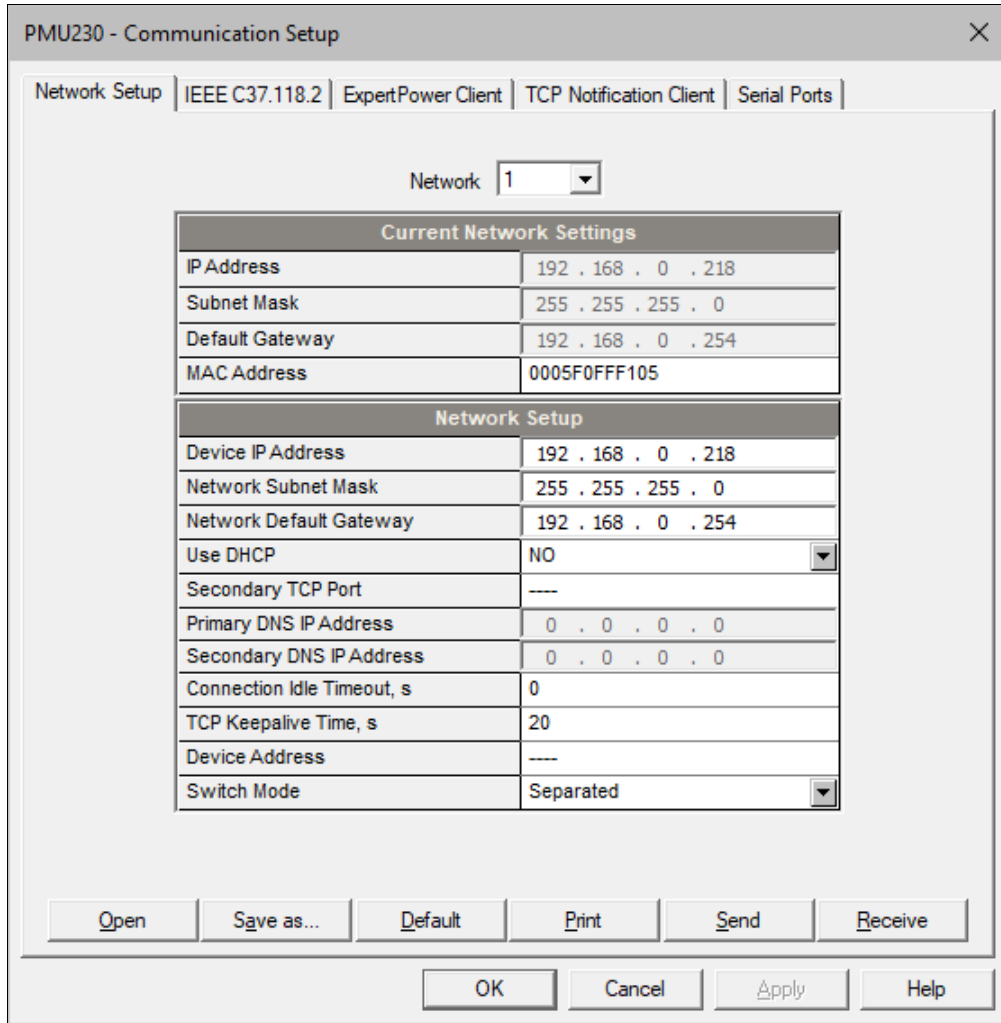

5.3.2 Serial Communications

Using the Front Display

Navigate to the Communication Setup menu, press the OK button to open the drop-down menu, and then select COM 1. Scroll through serial port settings using the UP and DOWN arrow buttons.

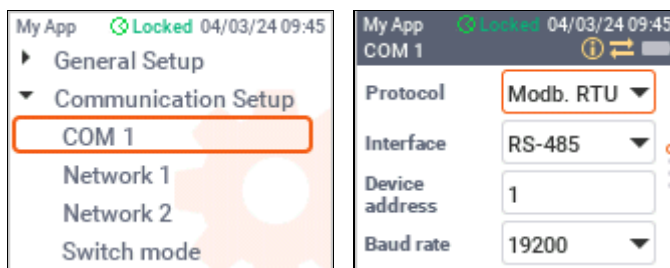

See the table below for available communication options.

Using PAS

Select Communication Setup from the Meter Setup menu and click the Serial Ports tab.

To change the port settings in your device, select desired port parameters and click Send.

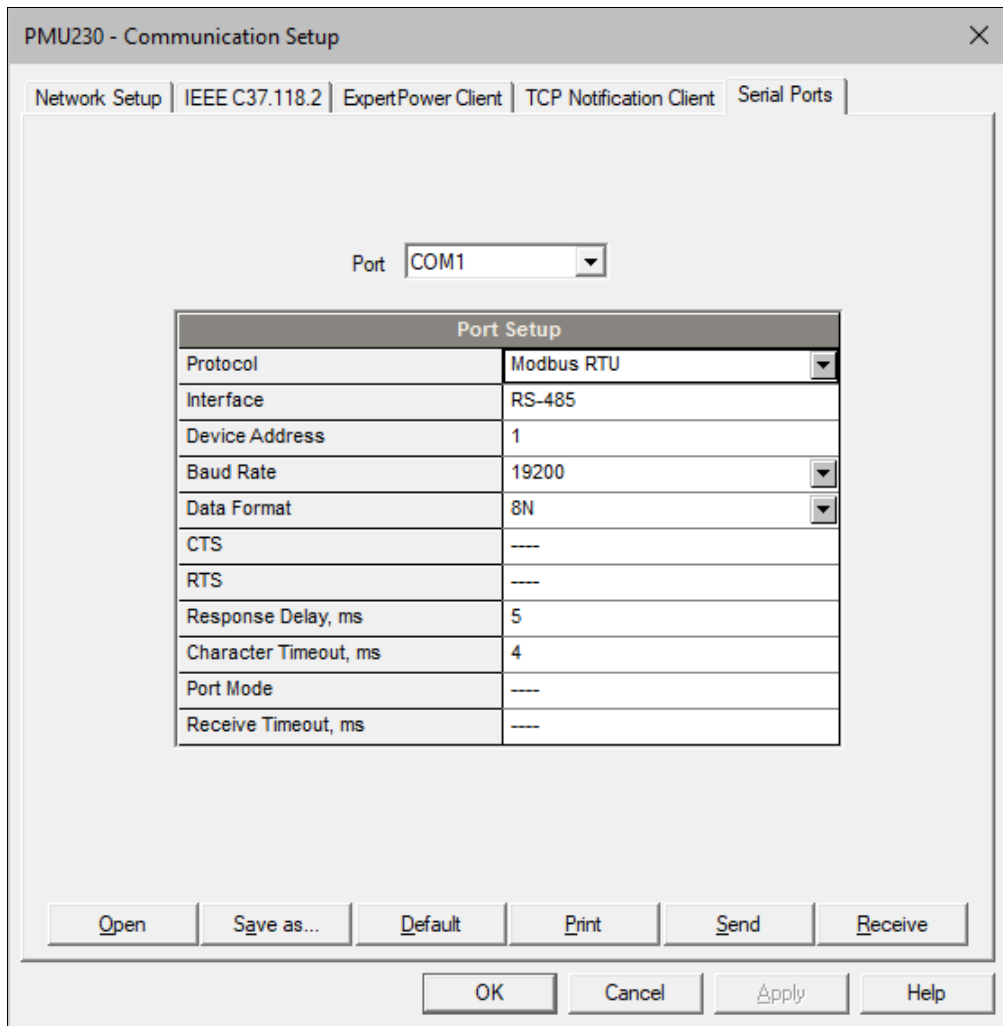

The following table lists available communication options.

Parameter	Options	Default	Description
Protocol	Modbus RTU, Modbus ASCII, DNP3, IEC 60870-5-101	Modbus RTU	Communication protocol
Interface	RS485	RS485	Fixed for the port
Device address	1-247	1	Device communication address
Baud rate	2400, 4800, 9600, 19200, 38400, 57600, 115200 bps	19.2 kbps	Port baud rate
Data format	8N, 8E	8N	Data format and parity
Response delay, ms	0-99 ms	5 ms	Minimum delay before sending a response message
Character Timeout, ms	0-99 ms	5 ms	Inter-frame idle time to terminate frame reception

5.3.3 Configuring the TCP Notification Client

The TCP notification client can establish connections with a remote Modbus/TCP server and send notification messages either on events or periodically. See the PMU Modbus Reference Guide for more information on the client operation and the notification message structure.

To set up the notification client, select Communication Setup from the Meter Setup menu and click the TCP Notification Client tab.

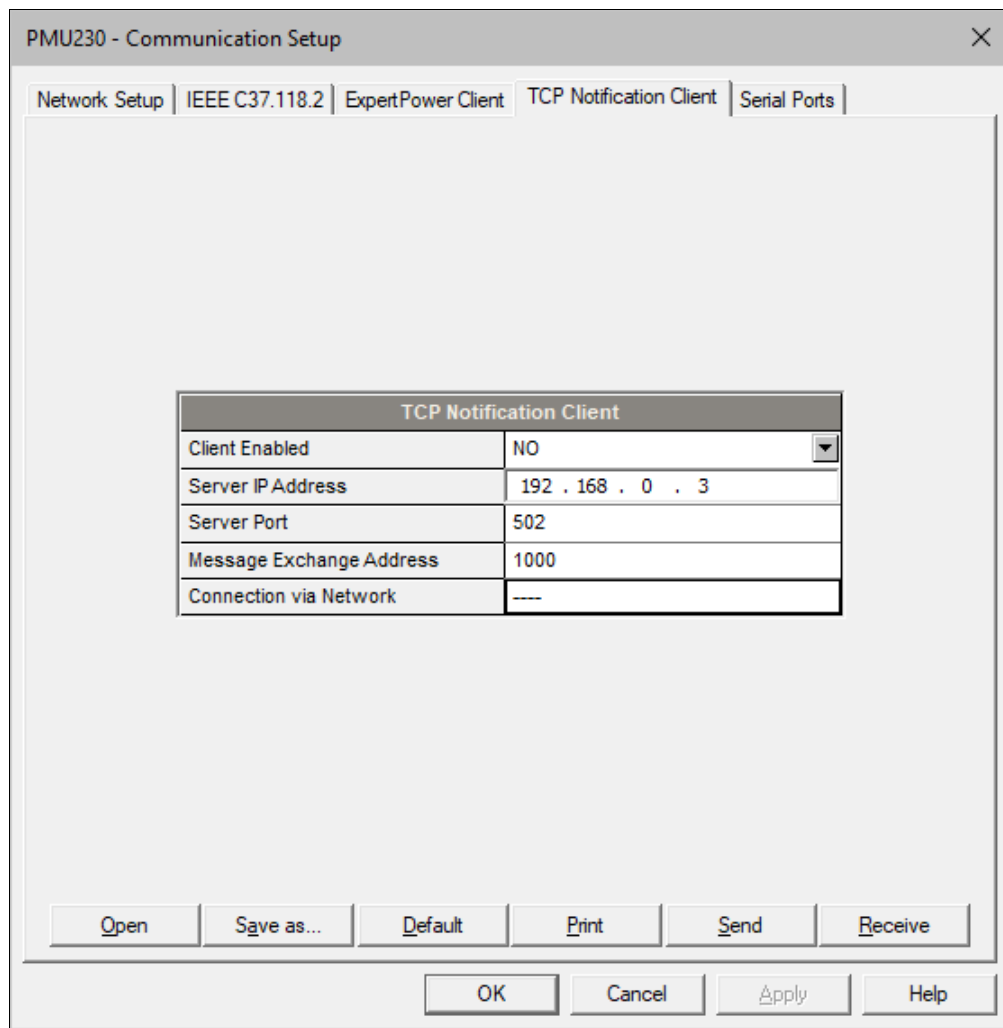

To enable the notification client, enter the server's IP address, change the Client Enabled status to YES, and click Send.

Client connections are initiated through the logic controller. To send event notifications, configure the setpoint to respond to the desired triggers and add the "Send notification" action to the end of the setpoint's action list.

5.3.4 Configuring the eXpertPower Client

The eXpertPower™ client provides communication with the eXpertPower™ server – the SATEC proprietary Internet services. Connections to the eXpertPower™ server are handled on a periodic basis and are managed by the server.

To set up the eXpertPower™ client, select Communication Setup from the Meter Setup menu and click the ExpertPower Client tab.

To enable the eXpertPower™ client, change the XPW Client Enabled status to YES, and click Send. Other client attributes are set to default.

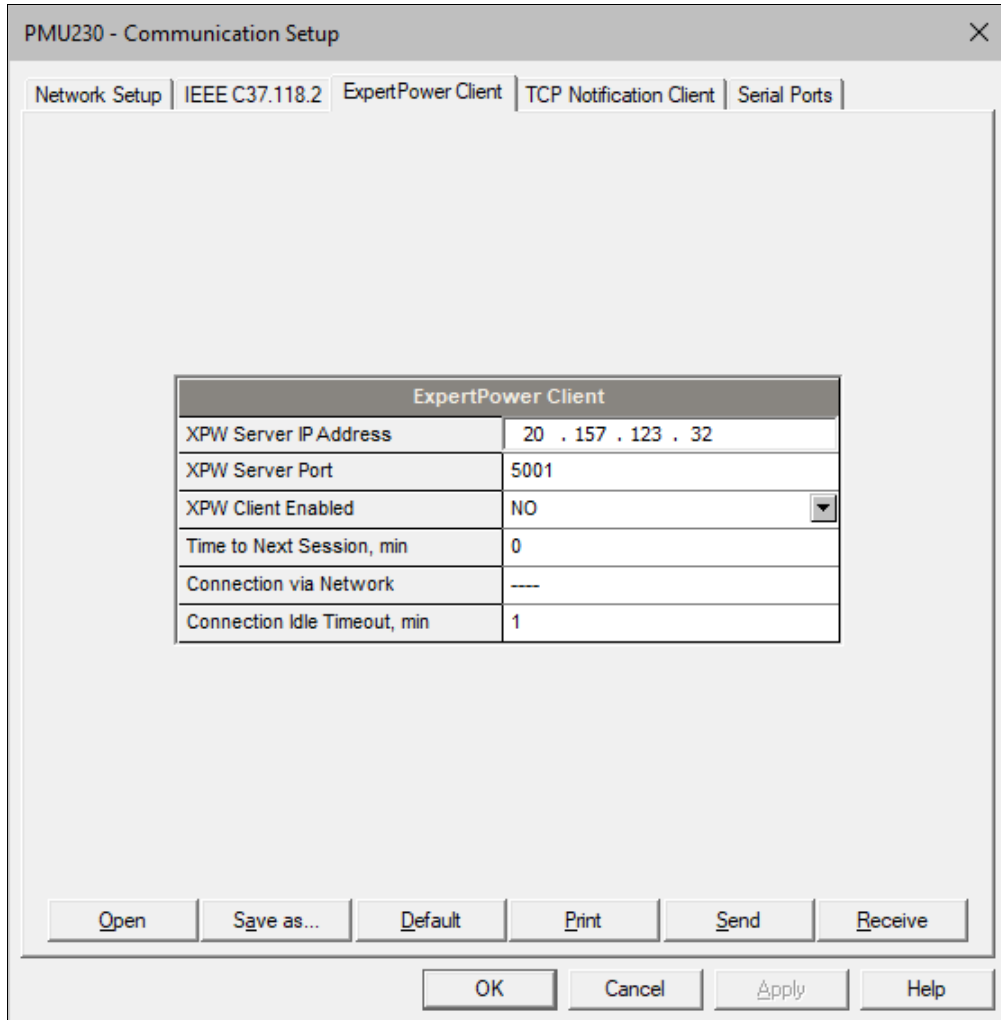

5.4 Configuring Recorders

5.4.1 Configuring Log Files

To view device file settings, click the “Memory/Log setup” icon  on the PAS toolbar, or select Memory/Log from the Meter Setup menu and click the Log Memory tab.

The file size is defined for each file statically when you configure files and will not change unless you reorganize your files.

To change file properties or create a new file:

1. Double-click the file you want to configure, or select the file and click “Configure File...”.
2. Select the number of records, the number of parameters per record and the file type.

3. Click OK.

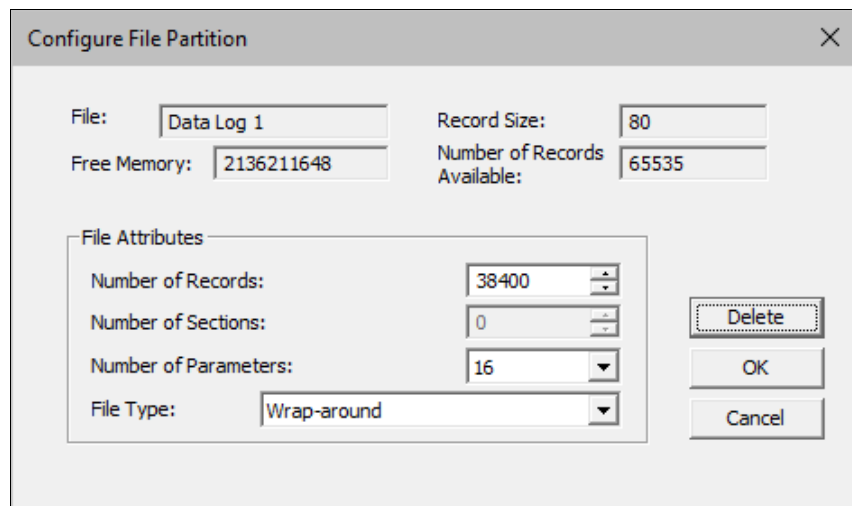
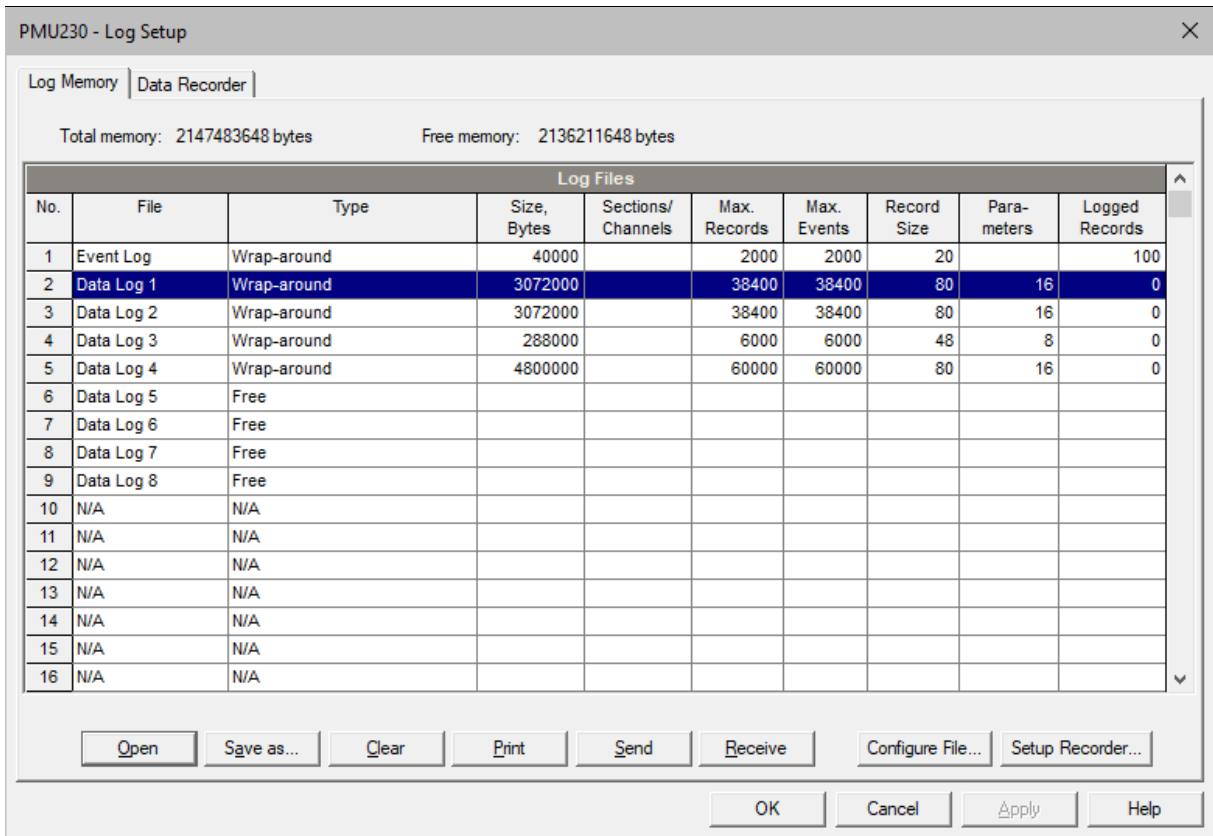

For your reference, the record size in bytes and the number of available records are shown at the top.

To delete an existing file:

1. Click Delete.
2. Click OK.

Save your new setup to the device database, and send it to the device.

5.4.2 Configuring the Data Recorder

The Data recorder is programmable for recording up to 16 data parameters per record in each of the data log files. The list of parameters to be recorded is configurable individually for each file.

To define the contents of the file:

1. On the Log Memory tab, select the data log file you want to configure and click “Setup Recorder”, or click the “Data Recorder” tab and select the corresponding log number.

PMU230 - Log Setup

Log Memory | Data Recorder

Log No: 1 Name: Synchrophasor

Data Log Parameters					
No.	Group	Parameter	No.	Group	Parameter
1	SYNCHROPHASOR	FrmNo	9	SYNCHROPHASOR	V3 Im
2	SYNCHROPHASOR	FREQ	10	SYNCHROPHASOR	I1 Re
3	SYNCHROPHASOR	DFREQ	11	SYNCHROPHASOR	I1 Im
4	SYNCHROPHASOR	V1 Re	12	SYNCHROPHASOR	I2 Re
5	SYNCHROPHASOR	V1 Im	13	SYNCHROPHASOR	I2 Im
6	SYNCHROPHASOR	V2 Re	14	SYNCHROPHASOR	I3 Re
7	SYNCHROPHASOR	V2 Im	15	SYNCHROPHASOR	I3 Im
8	SYNCHROPHASOR	V3 Re	16	---	---

Open Save as... Clear Clear All Print Send Receive

OK Cancel Apply Help

2. Configure the list of parameters that will be written to the log file. You are not allowed to select more parameters than you specified when configuring the file. Refer to Appendix C for a list of available parameters.
3. For your convenience, PAS follows your selection and helps you configure a number of adjacent parameters: when you open the “Group” box for the next parameter, PAS highlights the same group as the previous selection. If you select this group again, PAS automatically updates the “Parameter” box with the next parameter in the group.
4. Add a name for the data log file in the “Name” box. It will appear in the data log reports and in the Logs menu to the right of the data log number.
5. Save the new setup to the device site database, and send it to the device.

6 Device Management

This chapter describes how to perform management and control functions on your device using the front display and PAS.

To access device management options from PAS, you must be connected to the device.

6.1 Configuring User Passwords

Changing user passwords in the device requires high-level password authorization.

From the Monitor menu in PAS, select Administration -> Change Password and click the password you want to change.

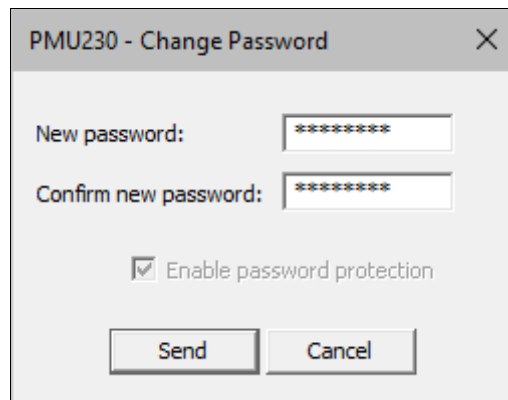

Enter a new password, repeat it in the following “Confirm new password” field, and then click Send to update the password in the device.

6.2 Setting Up Device Clock

Using the Front Display

Navigate to the Date & Time menu, press the OK button to open the drop-down menu, and then select Clock. Use the UP and DOWN arrow buttons to move through the clock parameters.

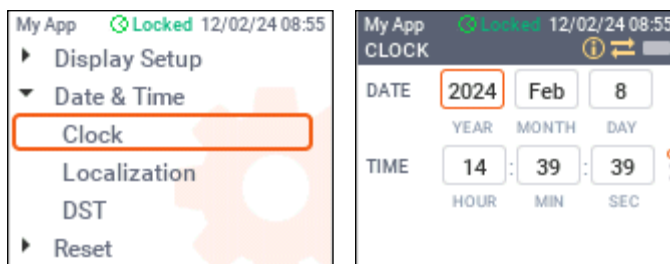

Using PAS

Click the Real-time Clock icon  on the PAS toolbar, or select RTC from the Monitor menu. The RTC dialog displays the current PC time and the time of your device.

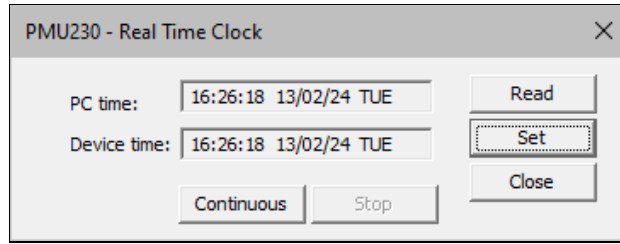

Click Set to synchronize the device clock with your PC’s clock.

NOTE

When the device is connected to an external UTC source, your setting will be overridden by UTC time adjusted to your local time using the time zone offset. If the time reading looks out of order, check your local time zone offset in the device’s Local Settings.

6.3 Manual Relay Control

Manual relay control allows you to manually operate (connect or disconnect) output relays by sending commands through communications.

To send a remote command to a relay, select Device Control from the Monitor menu in PAS and click the Remote Relay Control tab.

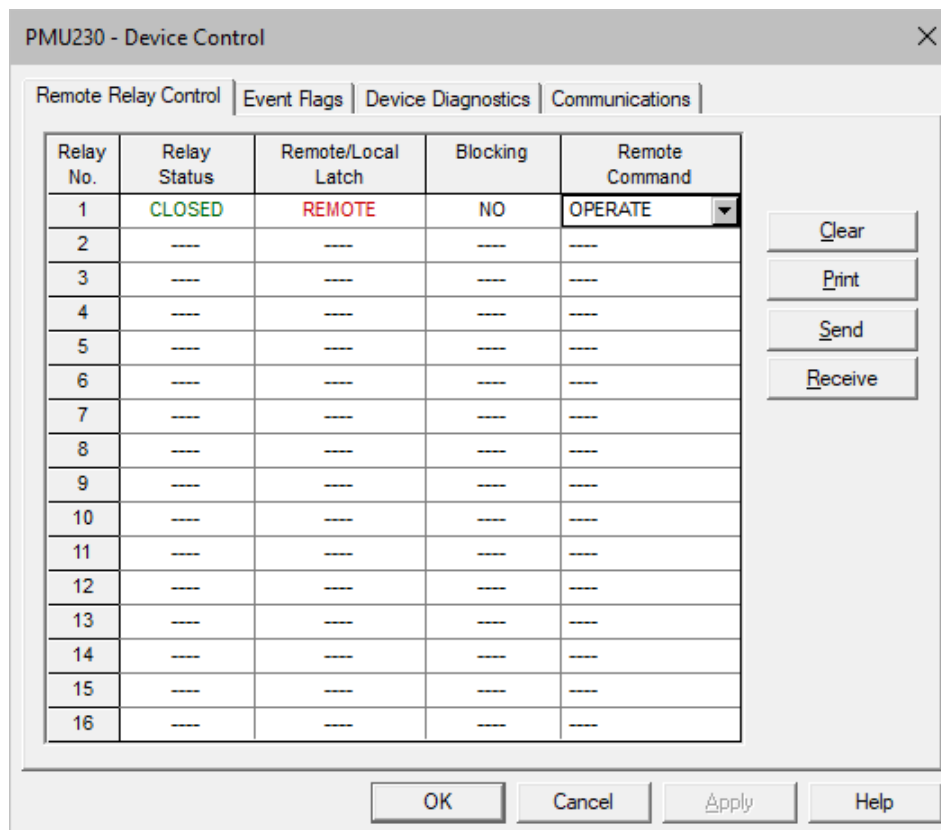

Select the relay command in the Remote Command box, OPERATE to activate the relay, or RELEASE to remove the command, and then click Send.

6.4 Manual Event Flag Control

Event flags are normally used as temporary event storage in control expressions during logic controller operations. You can change the state of event flags using PAS to manually control the operation of the logic controller.

Select Device Control from the Monitor menu in PAS and click the Event Flags tab.

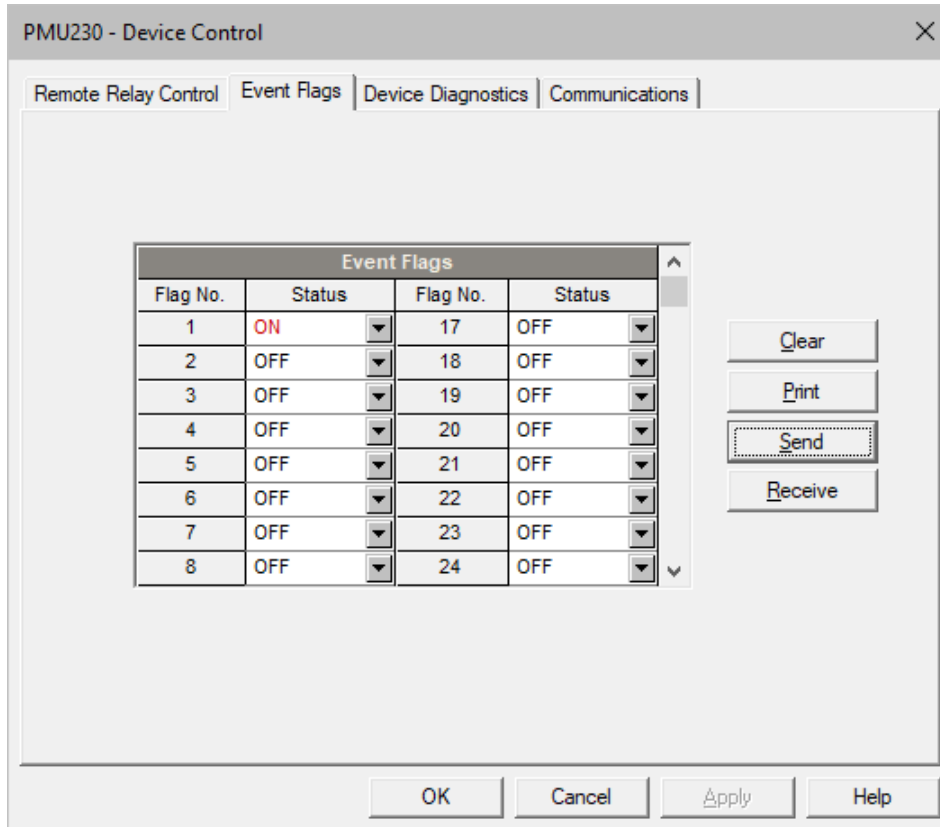

Select the flag status you want in the Status box for the corresponding event flag and click Send.

6.5 Viewing and Clearing Device Diagnostics

Device diagnostics can be cleared using the front display or communications.

Using the Front Display

See 4.3.6 “Events Menu” for how to view the device diagnostic on the display.

To clear the diagnostic messages, navigate to the Reset menu, press the OK button to open the drop-down menu, and then select Diagnostics. Press the OK button and then confirm your command.

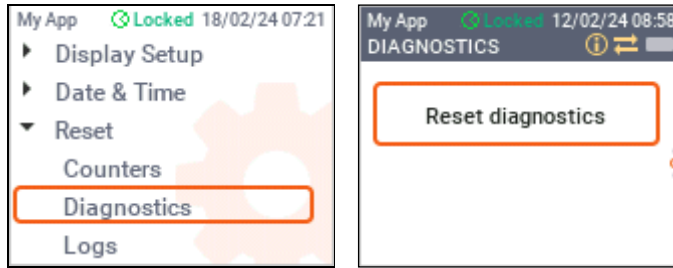

Using PAS

Select Device Control from the Monitor menu and click the Device Diagnostics tab.

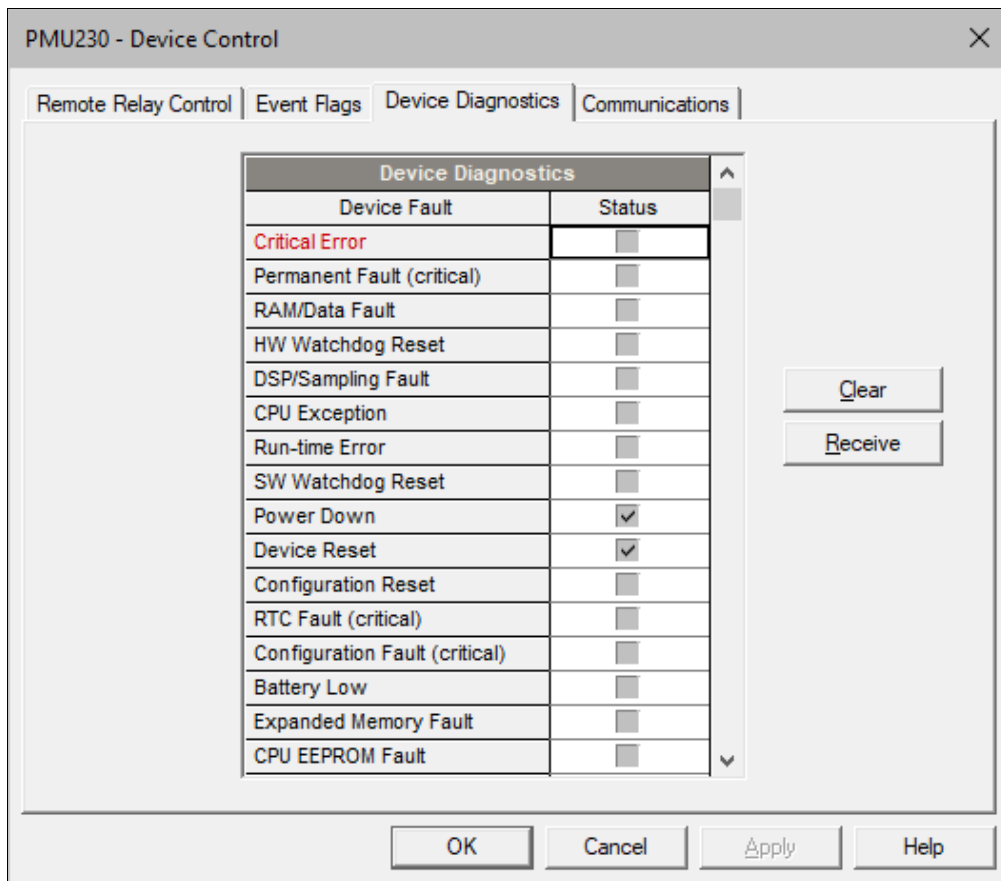

To clear the device diagnostics events, click Clear.

See Appendix E “Diagnostic Messages” for the list of diagnostic messages and troubleshooting device issues.

6.6 Clearing Counters

Using the Front Display

Navigate to the Reset menu, press the OK button to open the drop-down menu, select Counters, and then press the OK button.

To clear all counters, select “Reset all counters” and press the OK button. To clear a specific counter, select “Reset selected counter”, select the counter you want to reset, and then press the OK button.

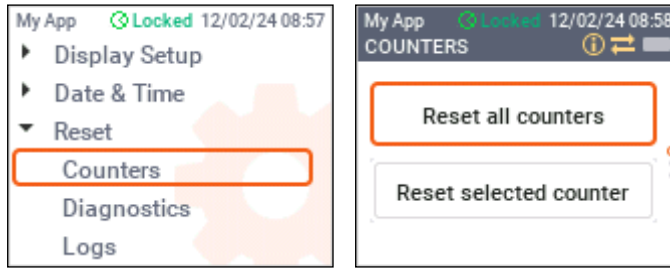

Using PAS

Select Reset from the Monitor menu and click Reset Counters.

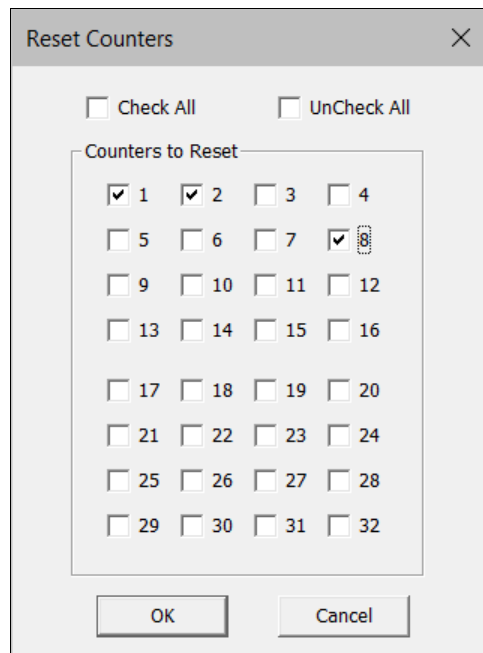

Click “Check All” to clear all counters, or check specific counters you want to reset. Click OK, and then confirm your command.

6.7 Clearing Files

Using the Front Display

You can only clear the device’s event log using the front display. Navigate to the Reset menu, press the OK button to open the drop-down menu, and then select Logs. Press the OK button and then confirm your command.

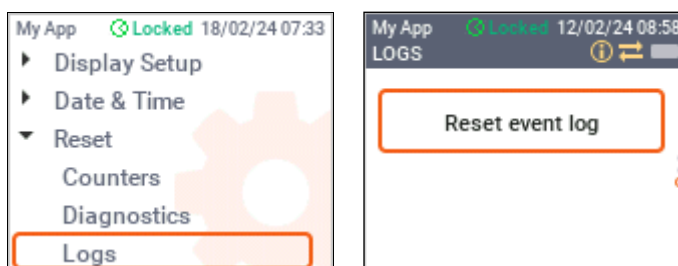

Using PAS

To clear all files:

Select Reset from the Monitor menu, click Clear All Files, and then confirm your command.

To clear the device's event log file:

Select Reset from the Monitor menu, click Clear Event Log, and then confirm your command.

To clear the device's data log:

Select Reset from the Monitor menu and click Clear Data Log.

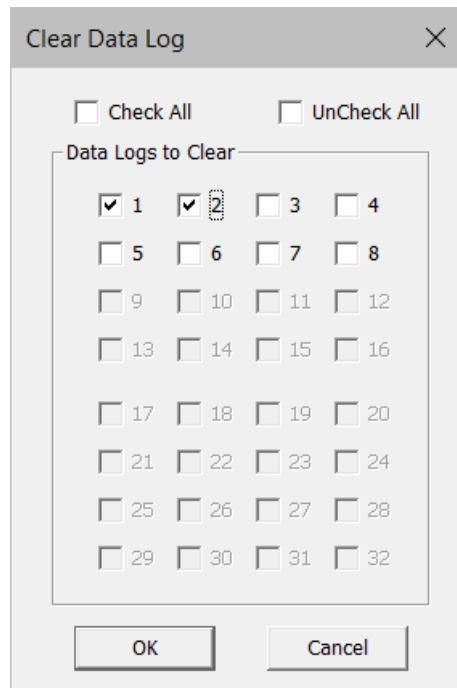

Click “Check All” to clear all data log files, or check specific files you want to clear. Click OK, and then confirm your command.

6.8 Firmware Update

You can update device firmware using any communication port installed in your device.

Firmware update is only supported via Modbus RTU/ASCII serial protocol and Modbus/TCP protocol. If you are connected to the device via a serial port, make sure it is in Modbus mode.

To download a firmware file to your device:

1. Make sure the On-line icon on the PAS toolbar is checked, select Flash Downloader from the Monitor menu, and confirm changes.
2. Point to the firmware update file, click Open, and then confirm the device update.

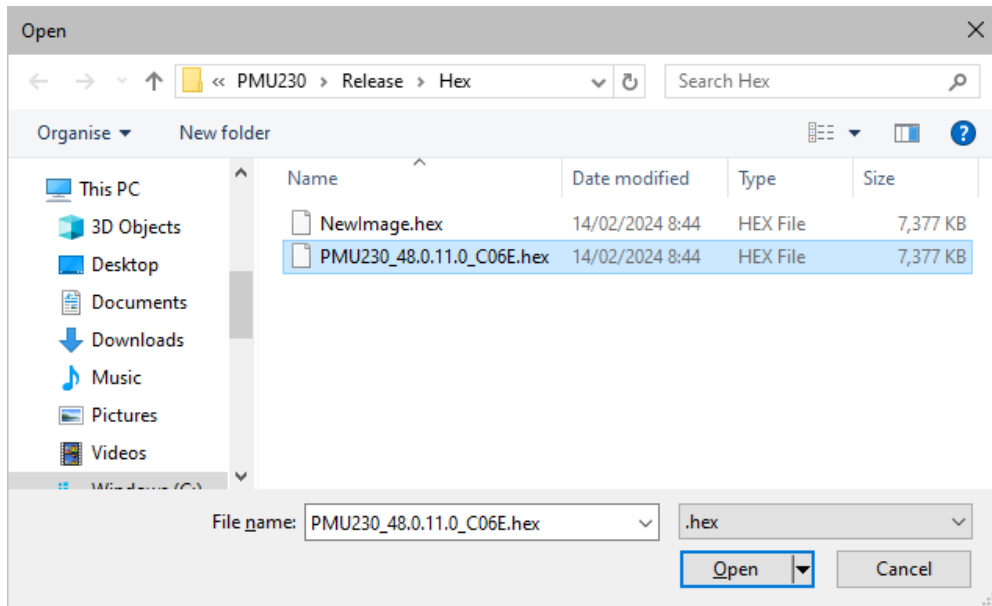

- When asked for the password, enter your user password, and click OK.

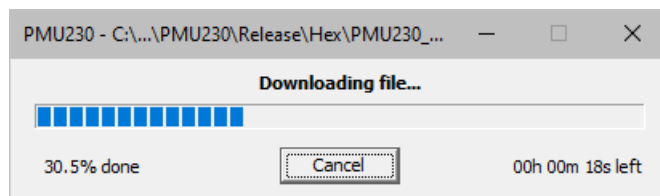

- Wait until download completes and the device reboots before any further manipulating with your device.

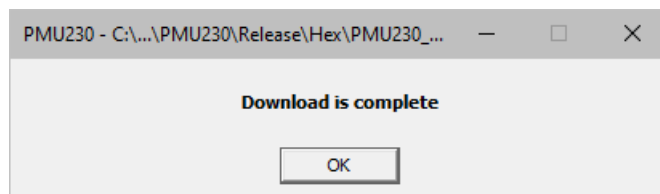

NOTE

After rebooting, your Internet connection may be temporarily lost. You may have to wait a while before PAS reestablishes a connection with your device.

7 Using PAS

The free PAS software is a configuration and data acquisition tool that allows you to configure the PMU and monitor your devices online through any communication port.

7.1 Working with PAS

7.1.1 Software Installation



PAS

Use PAS V1.5.5.41 or higher to access all PMU features. Use the installation package included with the device or download it from www.satec-global.com.

1. Log into Windows as an administrator or make sure you have administrator rights.
2. Make sure there is no a SATEC USB device connected to your computer.
3. Open File Explorer, locate the PAS installation package, click setup.exe with the right mouse button and select Run as administrator (your administrator privileges do not yet grant the programs you run the permission to make changes in the system folders).
4. Follow installation instructions on the screen.

PAS is installed to the C:\Pas folder by default, but you can change the installation folder during installation. Do not install PAS to the C:\Program Files folder to avoid possible ODBC security issues.

Once the installation is complete, a PAS icon appears on your Desktop. Double-click the PAS icon to launch PAS.

7.1.2 Creating a Site for your Device

PAS stores all communication and configuration data for your device in a configuration database called a site database. During setup, store all setup data in the site database so that PAS recognizes device properties regardless of whether you are connected to the device or work offline.

To create a new site database for your device:

1. Click the Configure Device icon  on the PAS toolbar or select Configuration from the Tools menu.
2. In the Site field, select the site that you want to use as the template for your new site's database. For the first time it will be "DefaultSite".
3. Click Sites on the right.
4. In the "Look in" field, select the folder where the new database will be saved. By default, this is the "Sites" folder. Enter the site name for your device in the "File name" field. Click New to create an empty database, or click Duplicate to create a copy of the template database, and click OK.
5. In the "Model" field, select "PMU" as the device type of your PMU. PAS automatically configures the appropriate settings for your device.
6. If you want to add any comments, type them into the "Comment" field.
7. Click OK.

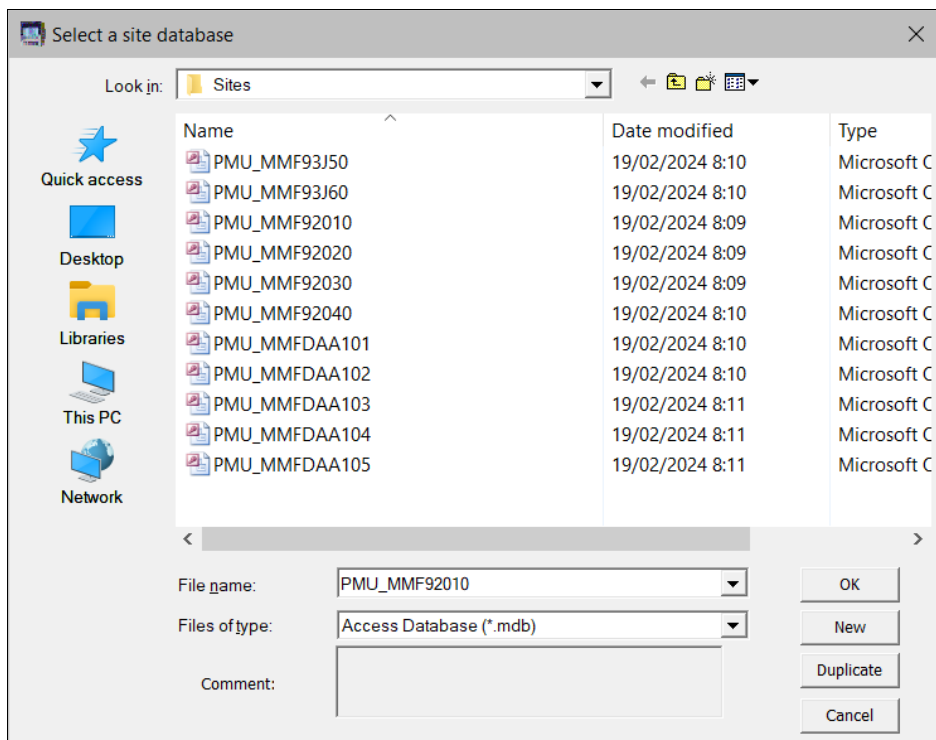
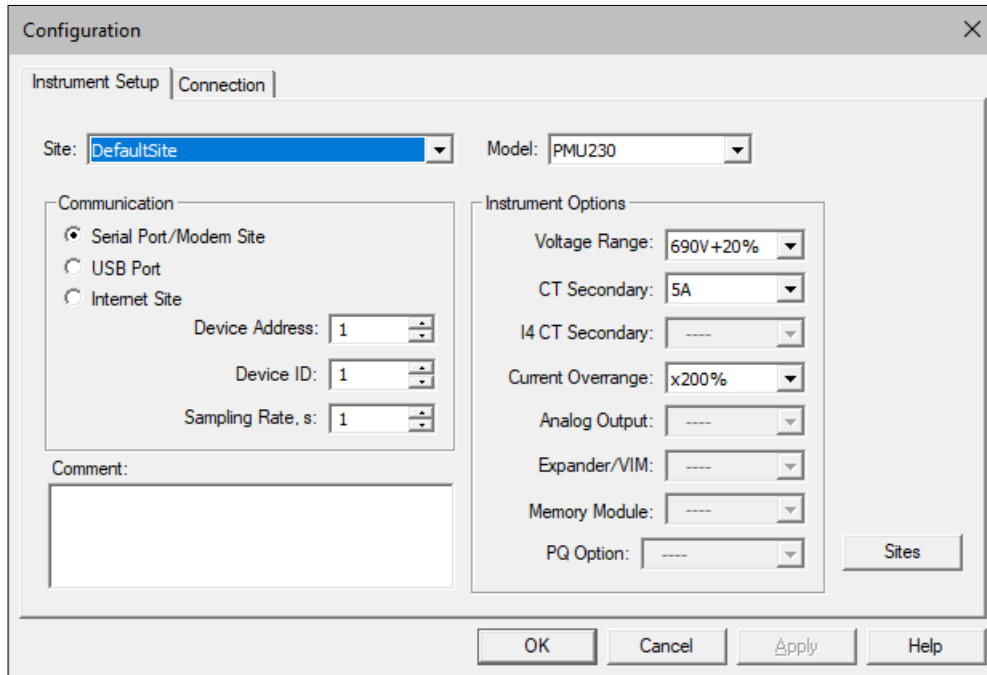

Once created, your new site appears in the site list in the PAS toolbar and in the PAS site tree. Check the “View/Hide Site Tree” icon  on the PAS toolbar to open the site tree pane on the left. Uncheck it if you want to hide the site tree.

You can organize the site tree so it is convenient for you to work with it. All sites are organized into groups. You can rename existing groups or create new groups and drag sites from one group to another with the mouse.

Click the plus sign to the left of the tree items to expand the tree and view device configuration information.

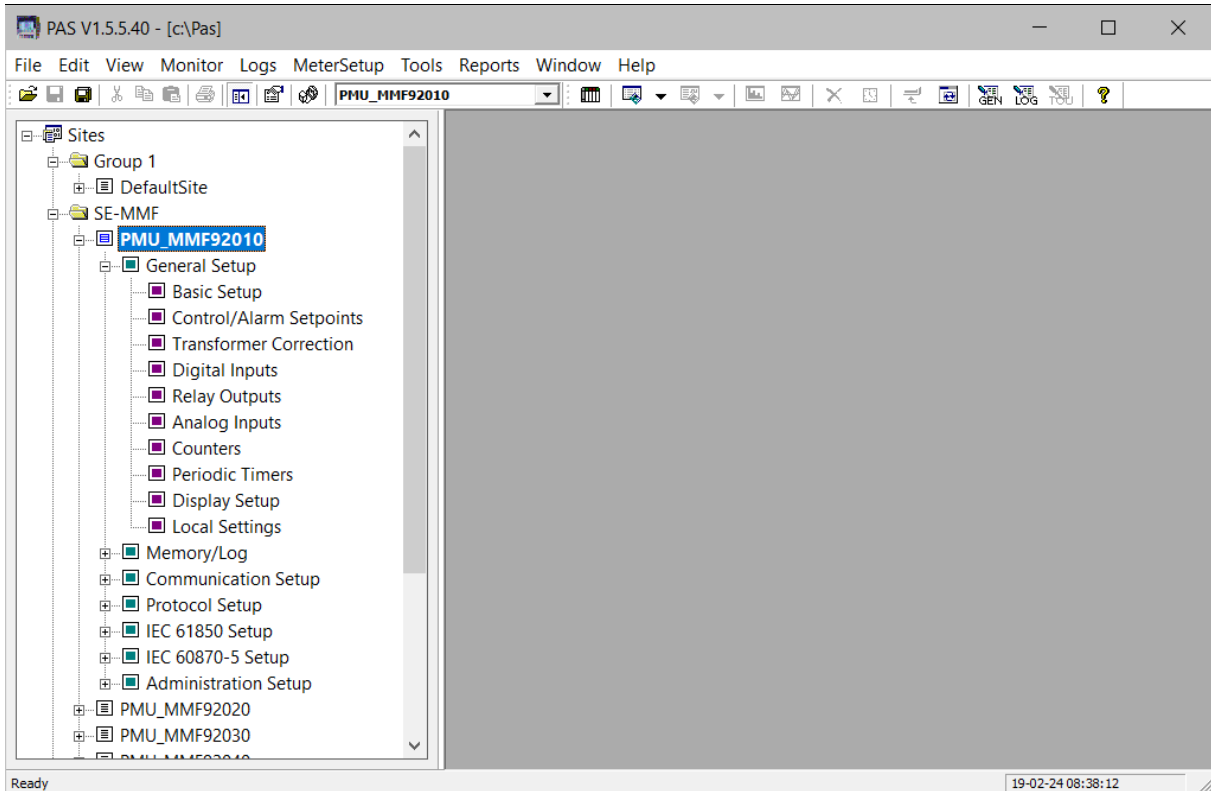

7.1.3 Setting up Communications

To configure communications with the PMU:

1. Click the Configure Device icon  on the PAS toolbar or select Configuration from the Tools menu. In the Communication group, select the type of connection to your device.
2. Set the device address you assigned to the PMU port.
3. In the “Sampling Rate” field, select the rate at which PAS will update data on your screen when continuously polling the device in the PAS Data Monitor.

The communication protocol and port settings must match the settings you have made in your device.

Communicating via the Internet

To communicate through the device’s Ethernet ports, you should provide the IP address of your device on the IP network.

1. On the Instrument Setup tab, select Internet Site and click the Connection tab.
2. Click “IP address” and enter the IP address of your device. The device’s factory set IP addresses are 192.168.0.203 for Ethernet 1 and 192.168.0.204 for Ethernet 2 ports.
3. In the “Protocol” field, select the communication protocol for the TCP port. The port number is configured automatically using the standard numbers assigned by IANA.
4. In the “Wait for answer” field, configure the amount of time PAS waits for a connection before reporting an error and the number of retries to receive a response from the device if communication fails.

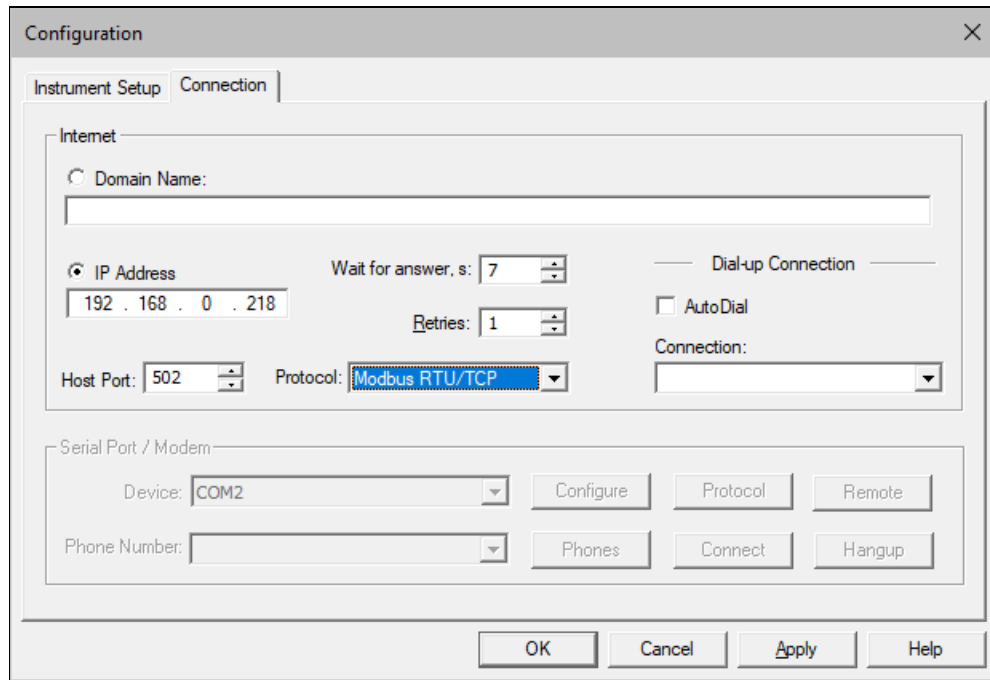

Communicating via USB

On the Instrument Setup tab, click USB Port, and then click OK.

Serial Communications

To configure your PC's serial port:

1. On the Instrument Setup tab, select Serial Port/Modem Site and click the Connection tab.
2. In the Device field, select the PC's COM port to which your device is connected and click Configure.

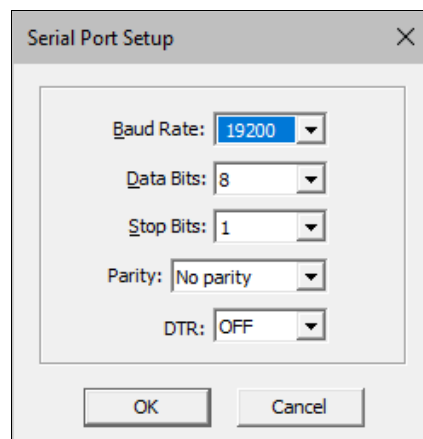

3. Select the baud rate and data format that match your device settings and click OK.

To configure the communication protocol:

1. On the Connection tab, click Protocol.

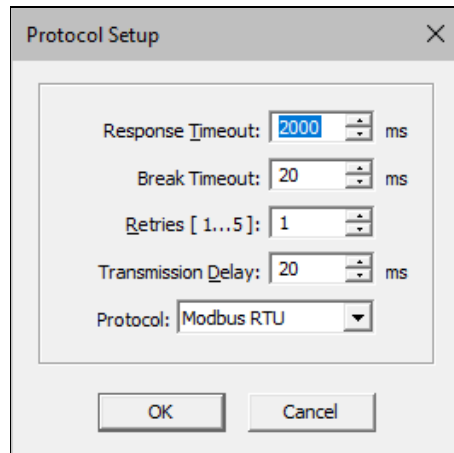

2. In the “Protocol” field, select the serial protocol that matches your device’s port settings.
3. In the “Response Timeout” box, define the maximum time PAS should wait for the device to respond before declaring a failure.
4. In the “Break Timeout” box, define the maximum amount of idle time between frames that PAS must wait after receiving the last character to complete receiving the frame. If you have many applications running on your computer, PAS may not be able to respond quickly enough to received characters and may drop the communication while the device is still transmitting. If you frequently receive the “Communication error” message, try increasing the Break Timeout. This time is added to the message transmission time, and increasing it too much can slow down communications.
5. In the “Retries” box, define the number of retries PAS should use to obtain a response from the device if communication fails.

7.1.4 Configuring the Device

Configuring Setups

You can prepare configuration data for your device offline without having to connect it to your computer.

NOTE

If the On-line icon on the PAS toolbar is checked, PAS will attempt to connect to the device and obtain the current configuration settings as soon as you open the settings tab. If you are not connected to a device, uncheck the On-line icon before entering the setup.

To prepare the setup for your device:

1. Select a device site from the list box in the PAS toolbar or from the PAS site tree.
2. Select the desired setup group from the Meter Setup menu and click the setup tab you want to create or modify. Alternatively, click the plus sign to the left of the site name in the site tree to expand the tree and click the desired setup.
3. Fill in the fields with new configuration data.

4. Click the “Save as...” button to save the new data to the device site database and click OK.

Always configure and save Basic Setup data in the site database first. PAS uses this data as a reference when configuring other setups.

To save your setup to another site’s database:

1. Click the “Save as...” button.
2. Select the target database and click OK.

You can also reuse a setting from another site by copying it to the current site’s database.

To copy a setup from another site’s database:

1. Click Open.
2. Select the source site database and click OK.
3. The open setup is copied to your dialog window.
4. Click the “Save as...” button.
5. Select the target database and click OK.

To copy all settings from one site’s database to another site's database:

1. In the site list on the PAS toolbar, select the source device site from which you want to copy settings.
2. Select “Copy to...” from the Meter Setup menu.
3. Select the target site database where you want to copy the settings and click OK.

Downloading Setups to the Device

You can update each setting in your device individually, or download all settings together from the site’s database.

Individual Download

To update a specific setup in your device:

1. Make sure the On-line icon  on the PAS toolbar is checked.
2. Select the device site from the site list on the PAS toolbar.
3. Select the desired setup group from the Meter Setup menu. Click the tab of the setup you want to download to the device. When the setup dialog opens, PAS retrieves and displays the device’s current settings.
4. If you want to download the settings saved in the site database, click Open and then click OK, otherwise fill in the fields with new configuration data before sending to the device, and then click Send.

Batch Download

To download all settings to the device at once:

1. Make sure the On-line icon  on the PAS toolbar is checked.
2. Select the device site from the site list on the PAS toolbar.

3. Select Download Setups from the Meter Setup menu.

Uploading Setups to PC

Individual Upload

To get a specific setup from your device:

1. Make sure the On-line icon  on the PAS toolbar is checked.
2. Select a device site from the site list on the PAS toolbar, and then select the desired setup group from the Meter Setup menu.
3. Click on the tab of the setup you want to read from the device. When the dialog opens, PAS retrieves and displays the current setup data from the device. Click Receive if you want to get the device settings again.
4. Click "Save As" to save the settings to the device site database, and then click OK.



Batch Upload

To upload all settings from the device to the device site database at once:

1. Check the On-line icon  on the PAS toolbar.
2. Select the device site from the site list on the PAS toolbar.
3. Select Upload Setups from the Meter Setup menu.

7.2 Monitoring Devices

7.2.1 Viewing Device Properties

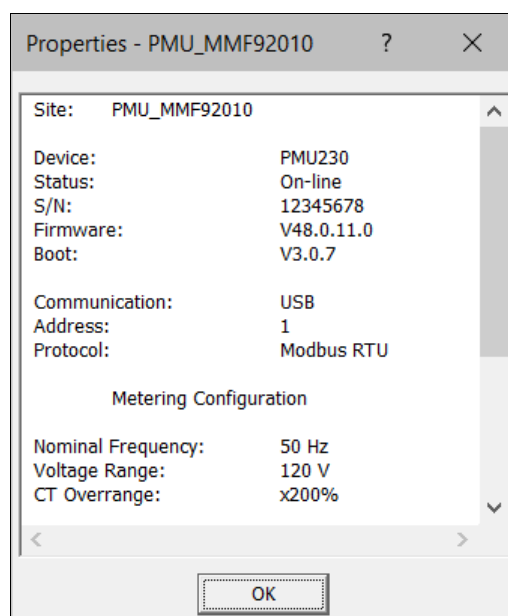

To view device properties, make sure the On-line icon  on the PAS toolbar is checked, check the site tree icon  on the PAS toolbar to open the site tree pane, right-click the device's site name, and select Properties.

The Properties window provides information about the device's factory settings and device firmware.



7.2.2 Viewing Real-time Data

To get real-time data from your device:

1. Make sure the On-line icon  on the PAS toolbar is checked.
2. Select the device site from the site list on the PAS toolbar.
3. Click the Data Monitor icon  on the PAS toolbar to select the default dataset for your device. To select a different dataset, click the down arrow on the Data Monitor icon  to open the drop-down list, and then select the dataset you want to view. Alternatively, point to “RT Data Monitor” in the Monitor menu and select a dataset from the list.

Real-time data is updated on the screen at the rate you set in the Instrument Setup.

Organizing Datasets

RT Data Monitor supports 32 programmable datasets, each containing up to 40 data parameters. Set #0 is intended for devices with a limited number of low-resolution scaled parameters and is not recommended for use with the PMU.

PAS comes with a number of preconfigured datasets and others are blank. To re-organize datasets, select RT Data Sets from the Monitor menu, or open the dataset you want to modify and click the Data Set icon  on the window toolbar.

The example below shows a user-configured dataset for monitoring synchrophasor data.

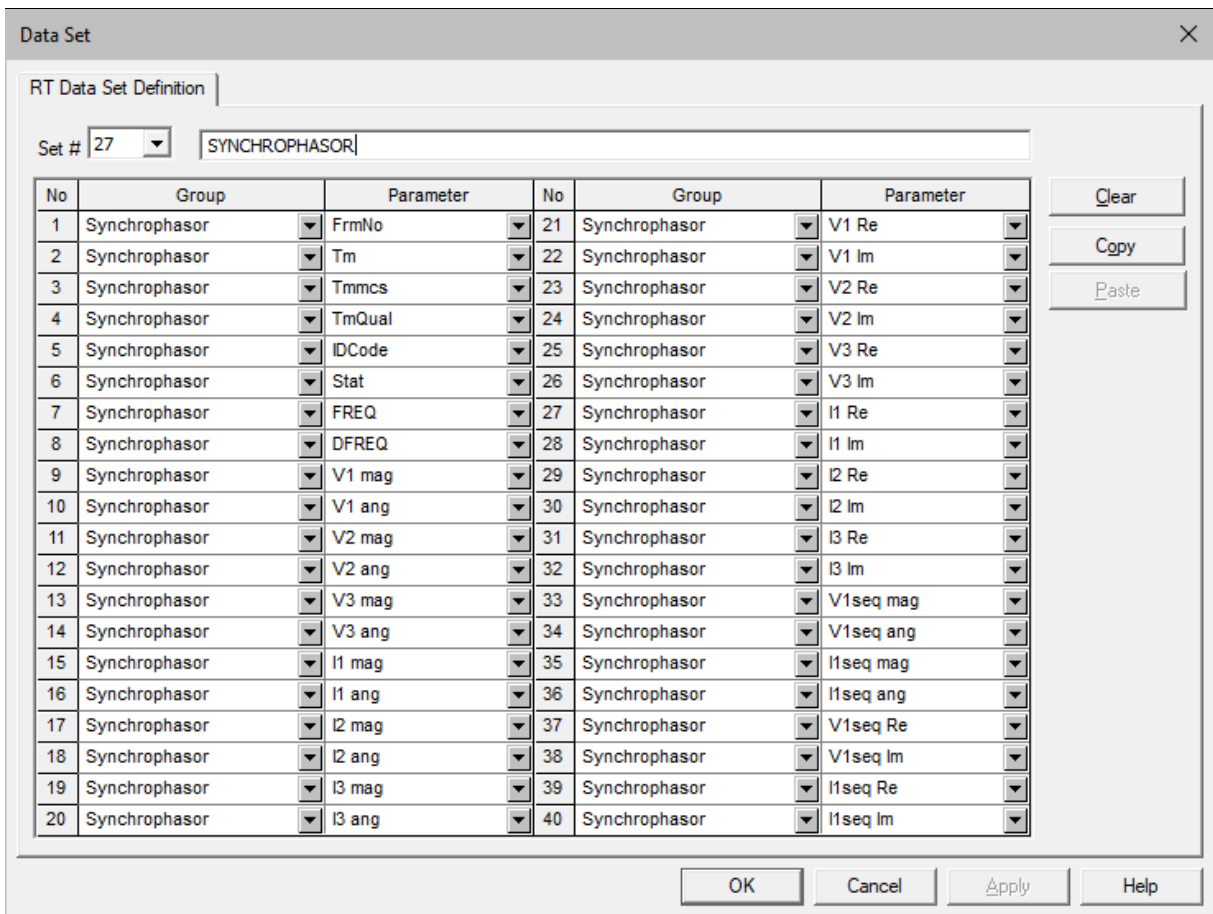

Polling Devices

To start polling data, click the Poll icon or Continuous Poll icon on the window toolbar. Click the Stop icon to stop polling.

You can open as many monitor windows as you like, either for different sites, or for the same site using different datasets. The open monitor window is tied to the selected device site and does not change when you select another site in the PAS site list.

The acquired data can be viewed in a tabular form or graphed as a data trend. The picture below shows a typical data monitor window.

Polling Options

To change polling options, click the Options icon on the window toolbar, or right-click on the data monitor window and select Options.

If you check “Do not stop on errors”, polling resumes automatically when a communication error occurs, otherwise polling stops until you manually restart it.

Viewing Data Table

See “Working with Tables” in 7.5.2 to learn about the options available in data tables.

PAS can display a single data record or multiple records in consecutive rows. To change the view, right-click on the data monitor window and select either “Wrap” to see a single record, or “UnWrap” to go to the multi-record view.

The pictures below show what the data monitor windows look like in non-wrapped and wrapped views.

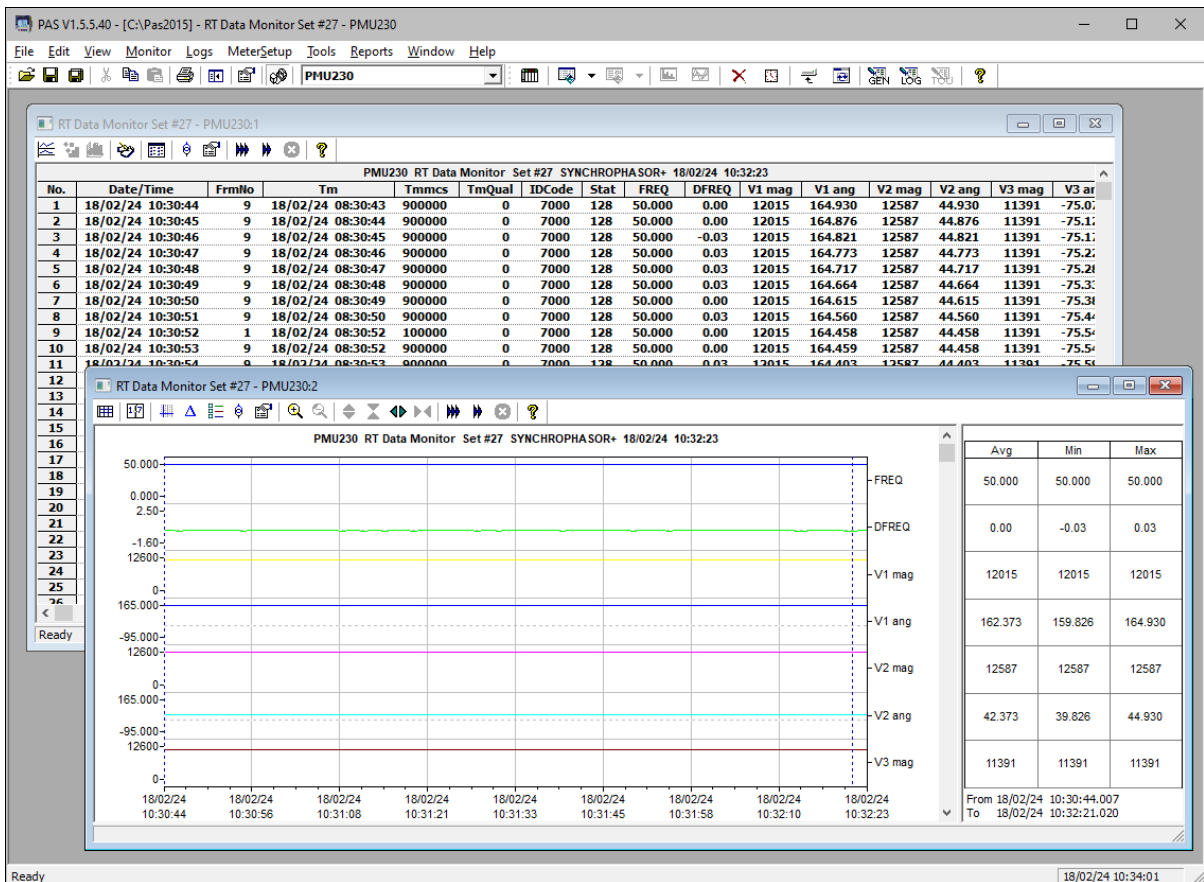

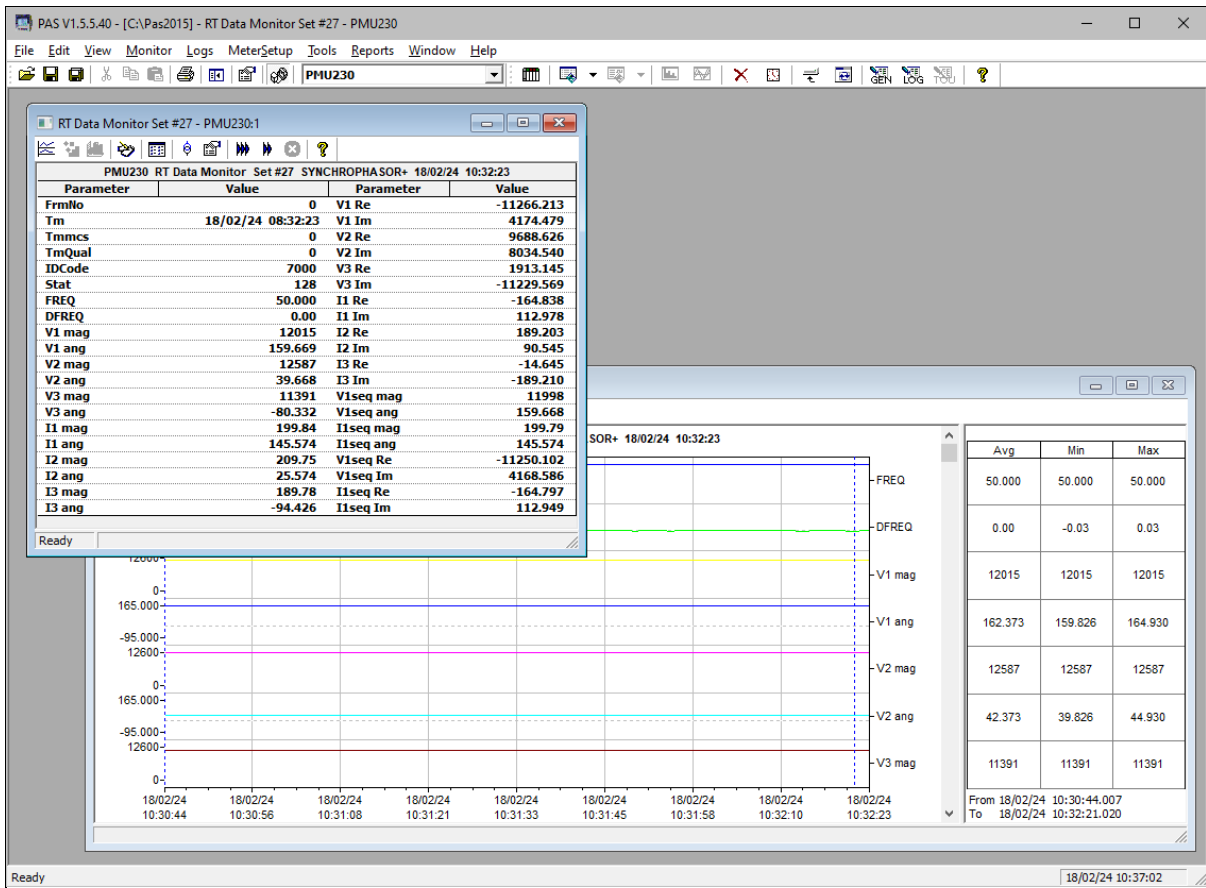

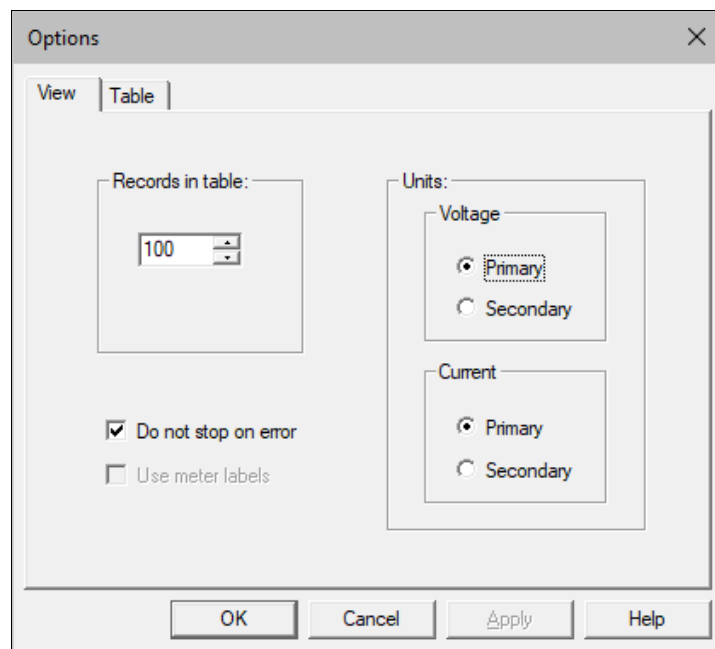

The number of records in the multi-record window can be selected on the Options tab: click the Options icon  on the window toolbar, or right-click on the data monitor window and select Options. When the number of records received exceeds the number of rows in the window, the window scrolls up and older records are erased.



Viewing Data Trend

To view a data trend, click the Data Trend icon  on the window toolbar. See “Working with Graphic Windows” in 7.5.2 for the options available in graphic windows.

Saving Data to a File

To save the acquired data to a file, click the Save icon  on the PAS toolbar, select a database or enter a name for the new database, and then click Save.

To avoid confusion, do not store data files into the “Sites” folder where site databases are located.

Printing Data



To see how the report will look when printed, select Print Preview from the File menu.

To print the data table or trend graph, click the Print icon  on the PAS toolbar, select a printer, and click OK.

7.2.3 Real-time Data Logging

PAS can automatically save data records to a database while updating data on the screen.

To set up real-time logging:

1. Make sure the On-line icon  on the PAS toolbar is checked.
2. Open the Data Monitor window.
3. Click the “RT Logging On/Off” icon  on the window toolbar, or select “RT Logging Options” from the Monitor menu.
4. Select a database or enter a name for the new database and select the folder where you want to save it.
5. Select the number of tables and the number of records in each table that you want to record.
6. Set the file update rate for automatic recording. It must be a multiple of the sampling rate defined in the Instrument Setup dialog.
7. Click Save.

When you start real-time data polling, PAS automatically saves the acquired records to the database at the rate you specified.



In order for data to be recorded continuously, the “RT Logging On/Off” icon  on the window toolbar should be checked at all times. You can pause logging by unchecking this icon, and then resume logging by checking it again.

7.3 Viewing Event and Data Files On-line

It may be useful to retrieve and view a portion of the recorded data from your device online while you wait for new logged data to appear.

PAS can retrieve recorded data from a specific log file without storing it to a file on your PC. The data is only displayed in a window on your screen. You can then manually save it to the database if you wish.

To view recorded data online, open the Logs menu and select the file you want to view. Only new records that have not yet been read through this communication port will be retrieved. Click the Poll icon  on the window toolbar to read more new records.

If you want to view the entire log file from the beginning, click the Restore log icon , and then click the Poll icon .



7.4 Retrieving and Storing Files

PAS can retrieve recorded event and data files from your devices and save them to files on your PC in Microsoft Access database format on demand or periodically using the Upload Scheduler that can automatically retrieve data on a predefined schedule.

Unless you change the target database location, new data is added to the same database, so you can store long-term data profiles in the same database regardless of the upload schedule you selected.

7.4.1 Retrieving Files on Demand

To retrieve recorded files from your device:

1. Select a device site from the list box on the PAS toolbar.
2. Make sure the On-line icon  on the PAS toolbar is checked.
3. Click the Upload Log Files icon  on the PAS toolbar or select Upload Logs from the Logs menu.
4. Select a database or enter a name for the new database, and select the folder where you want to save it.
5. Click “Select Logs” and check the boxes for the files you want to retrieve from the device.

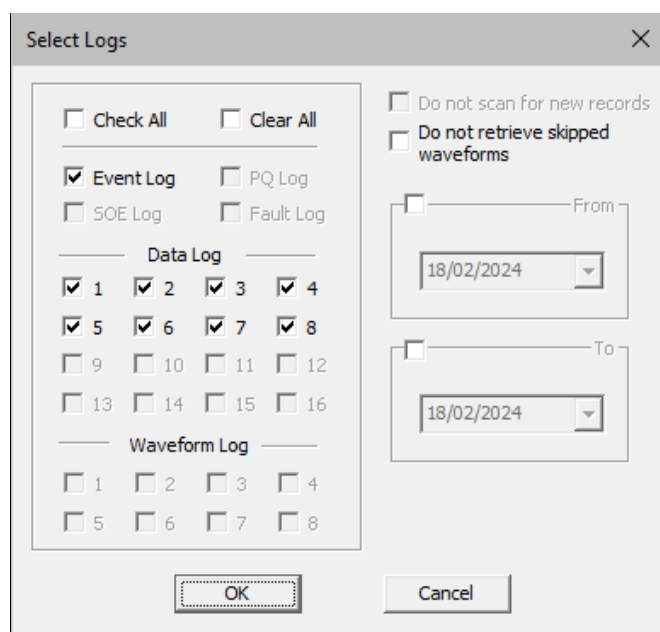

6. To retrieve data starting with a known date, check the “From” box and select the start date for retrieving data.
7. To retrieve data recorded before a known date, check the “To” box and select the latest date to retrieve data.
8. Click OK.

7.4.2 Using the Upload Scheduler

To set up the Upload Scheduler:

1. Click the Upload Scheduler icon  on the PAS toolbar or select Upload Scheduler from the Logs menu.
2. Click Add Site, specify the site database for which you want to organize the schedule, and click OK.

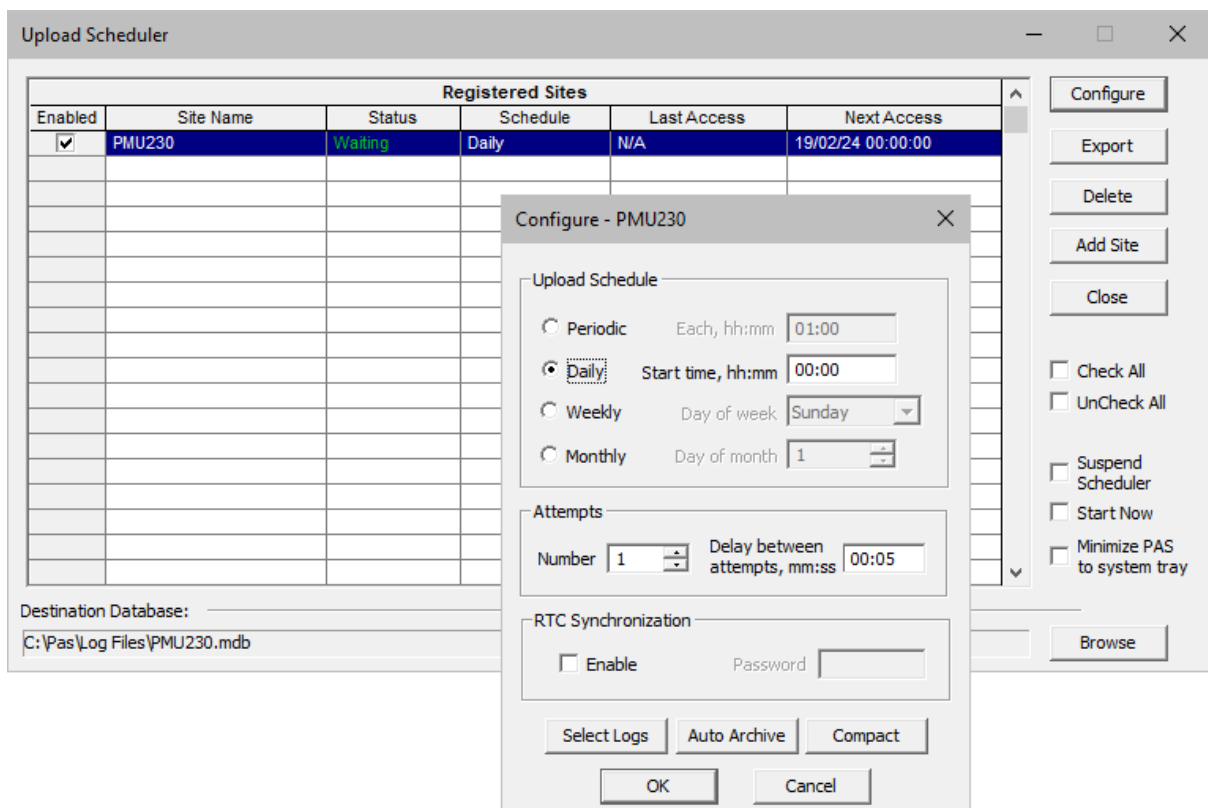

3. Click Browse and select a database to store the retrieved data, or enter a name for the new database, select the folder where you want to save it, and click OK.
4. Click Configure or double-click the site row.
5. Select a daily, weekly or monthly schedule, and set the start time. If you want to upload data periodically at predefined intervals, click “Periodic” and specify the time period in hours and minutes.
6. Select the number of attempts to upload data in case of temporary connection problems or when your device is unavailable, as well as the delay between attempts in minutes and seconds.

7. Click Select Logs, check the boxes for the files you want to upload on a schedule, and click OK.
8. Check the Enabled box on the left to activate the schedule and click Close to save it.

For the scheduler to work, the On-line icon  on the PAS toolbar must always be checked. If you uncheck it, the scheduler stops running. This does not result in any data loss, because the scheduler will resume as soon as you check this icon again.

Pausing the Scheduler

To pause the Upload Scheduler, check the Suspend Scheduler box on the right. To activate the Upload Scheduler, leave this box unchecked.

Running the Scheduler on Demand

You can start the scheduler at any time outside of your schedule by checking the Start Now box on the right. Once the upload is complete, the box is automatically unchecked.

Reviewing Upload Issues

If the Upload Scheduler fails to retrieve data, some data is missing, or another problem occurs, it writes an error message to the system log file. Select System Log from the View menu to review this file.

7.4.3 Exporting Files

PAS can convert data log files stored in mdb databases into Microsoft Excel workbook, CSV, or Electrotek PQDIF file format.

The first and second rows of the Excel and CSV tables list the data names and data codes that identify the recorded data and are intended for use in automated table processing. Each table row is tagged with a device ID, which you can specify in the Instrument Setup tab when creating the site database for your device.

PQDIF file names contain the site name followed by the timestamp of the first event recorded in the file, and may look like SITE-NAME_20240125T133038.pqd.

Manual Converting Files

To manually convert a data log file:

1. Click the Export icon  on the PAS toolbar.
2. Open the database and data table you want to export.
3. Select the folder where you want to store the exported files, enter a file name that identifies your files, select the desired output file format, and click Save.

PQDIF files are usually written in a compressed format. If you do not want your files to be compressed, uncheck the Compress box before saving the file.

Automatic Converting Files

To automatically convert data files using the Upload Scheduler:

1. Open the Upload Scheduler.
2. Select the site row with the left mouse button and click Export.

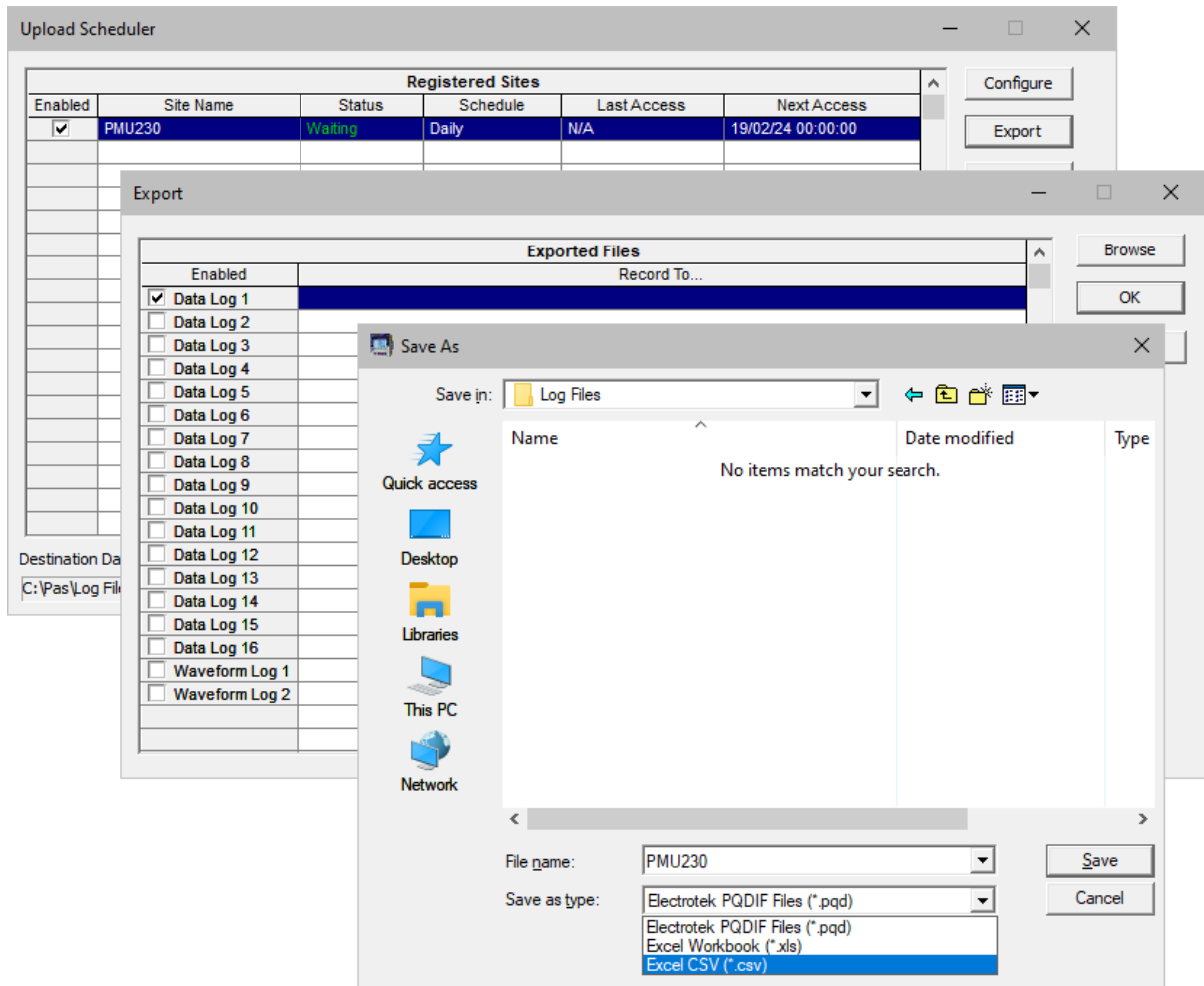

3. Check the Enabled box for the data log file that you want to automatically convert during upload.
4. Highlight the “Record to...” row for the selected table and click Browse.
5. Select the folder where you want to save the converted files, enter a file name for the converted files, select the output file format, and click Save.
6. Repeat the same for all data log files you want to convert.
7. Click OK.

7.4.4 Archiving Files

Microsoft Access databases tend to grow quickly. Files larger than 0.5 Gigabytes can drastically slow down database performance.

To avoid enormous file grows, you can either change the target database periodically, or use the Upload Scheduler’s file archiver to automatically move old data to archives.

The Upload Scheduler archives files on a weekly, monthly or yearly schedule. Archiving data creates a new database and moves old data with the expired archiving date from your current database to the archive.

The archive file retains the original database name plus the date of the oldest database record, so you can easily identify your archives and work with them the same way you would work with a regular database.

To set up a schedule for periodic archiving your files:

1. Click Configure in the scheduler window or double-click the site row.
2. Click Auto Archive.

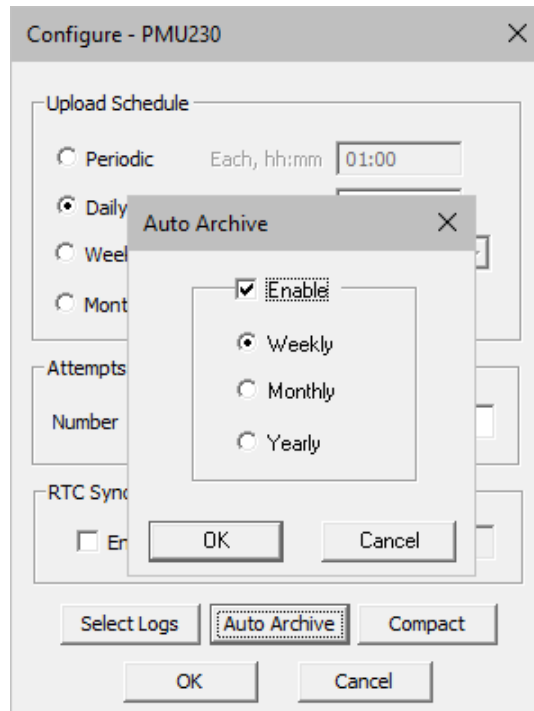

3. Check the Enable box and select the schedule period for archiving your files.
4. Click OK.

To avoid archiving partially updated data, archiving is performed one day after the expiration of the scheduled period and no earlier than 2 a.m.

7.4.5 Compacting Files

The compact process does not compress the data, but rather makes your database files smaller by eliminating unused space. This also helps improve database performance.

On exit, PAS compacts all databases that were modified during program execution. When PAS is running continuously, you can tell it to compact databases in the background on a predefined schedule.

To set up a schedule for periodic compacting your files:

1. Click Configure in the scheduler window or double-click the site row.
2. Click Compact.
3. Check the Enable box and select the schedule period for compacting your files.
4. Click OK.

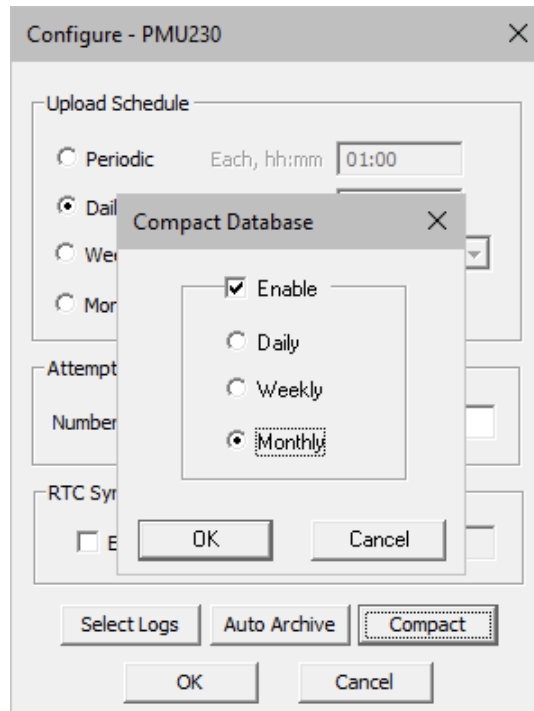

7.5 Viewing Files

7.5.1 Working with Files

Recorded files that you retrieve from devices and save in databases are stored in data tables.

Opening a Database Table

To open a database table:

1. Click the Open icon  on the PAS toolbar, or select "Open..." from the File menu.
2. In the "Files of type" box, select "Access Database (*.mdb)", select the folder where your files are located and point to the file you want to open.
3. Select the table you want in the right pane and click Open or double-click the table name.

The names of the last 16 files you opened are listed in the File menu, so you can reopen them directly from the File menu.

Saving Data to a File

To save data from the open data table to a file:

1. Click the Save icon  on the PAS toolbar and select the folder where you want your file to be saved.
2. Select a target database or enter a name for the new database.
3. Click Save.

To avoid confusion, do not store data files into the "Sites" folder where the device site databases are located.

7.5.2 Viewing Options

Customizing Views

Changing Date Order

To change how the date is displayed in PAS:

1. Select Options from the Tools menu and click the Preferences tab.
2. Select your preferred date order and click OK.

Selecting Timestamp Format

The timestamp is typically recorded and displayed on the screen at 1 ms resolution. If you have an application that does not support this format, you can tell PAS to drop the milliseconds.

To change how the timestamp is recorded and displayed:

1. Select Options from the Tools menu and click the Preferences tab.
2. Select your preferred timestamp format and click OK.

Working with Tables

Selecting Font and Grid

To change the table font or grid line type:

1. Click the Options icon  on the window toolbar, or right-click on the table and select Options, and click the Table tab.
2. Select a font type, font size, and how the table grid should be displayed, and click OK.

Show Decimal Places in Whole Numbers

Numbers without significant decimal digits are displayed without decimal places by default. You can tell PAS to align the columns so that the integer parts appear vertically aligned, whether they have significant decimals or not.

To change how whole numbers are displayed:

1. Click the Options icon  on the window toolbar, or right-click on the table and select Options, and click the Table tab.
2. Check the "Show decimal places..." box and click OK.

Selecting Primary and Secondary Units

Voltages and currents can be displayed in primary or secondary units.

To change the units of measurement, click the Options icon  on the window toolbar, or right-click on the table and select Options, select the units you want, and click OK.

Copying a Table

To copy all or part of the table to the Clipboard or another application, such as Microsoft Excel or Word:

1. Right-click on the table and choose Select All, or click the top-left corner of the table where “No.” is displayed.
2. Click the Copy icon  on the PAS toolbar or right-click on the table and choose Copy.
3. Launch the application where you want to copy the data, position the cursor where you want it, then double-click on the window and select Paste.

When copying, table columns are separated by tabs.

Printing a Table

1. To check how your document appears on a printed page, select Print Preview from the File menu.
2. To print the table, click the Print icon  on the PAS toolbar, select a printer, and click OK.

Working with Graphic Windows

Selecting the Time Range

To change the time range for your graph, click the Time Range icon  on the window toolbar, and then select the date and time range you want.

Selecting Channels

To select the channels, you want to view on the screen, right-click on the graph window, select “Channels...”, check the channels you want to display, and then click OK.

The checkboxes for channels that are not available in the current view are dimmed.

Selecting Primary and Secondary Units

Voltages and currents can be displayed in primary or secondary units.

To change the units of measurement, click the Options icon  on the window toolbar, or right-click on the graph window and select Options, select the units you want, and click OK.

Selecting Line Styles and Colors

Channel lines can be displayed using different colors and line styles.

To change line colors or styles, right-click on the graph window, select “Options...”, click the Display tab, adjust the colors and styles, and then click OK.

Selecting Grid and Frame Colors

Right-click on the graph window, select “Options...”, and click the Display tab.

To change the color or style of the grid lines, click the Grid line in the left pane and select the color and style of the grid. To turn off the grid, uncheck the Grid Visible box.

To change the window frame color to white, check the White Frame box on the right.

Using Marker Lines

The trend window has two blue dashed line markers. The left marker indicates the starting position and the right marker indicates the ending position for calculating the average and peak values.

To change the position of the marker, click the Set Marker icon  on the window toolbar, or right-click on the graph window and select Set Marker, and then click the point where you want to place the marker.

You can also drag both markers with the mouse or use the right and left arrow keys on your keyboard to change the position of the marker. Click on the graph window to allow the keyboard to get focus before using the keyboard.

Delta Measurements





To measure the distance between two trend points, click the Delta icon  on the window toolbar, then click the first point, and then the second point.

The first reference point remains frozen until you close and reopen Delta, and the second point can be placed anywhere within the graph line. You can measure delta in both directions.

To turn off delta measurements, click the Delta icon once again.

Using Zoom

You can use a horizontal zoom to change the timeline of the graph.

Use the horizontal arrow icons   on the window toolbar to zoom in and out. One click gives you 100% horizontal zoom. Two icons   representing magnifying glasses provide proportional zoom in both directions.

Copying a Graph

To copy a graph or part of a graph to the Clipboard or another application, such as Microsoft Excel or Word:

1. Right-click on the graph window and choose Copy All, or Copy Graph.
2. Place the cursor where you want to copy the graph, double-click on the window and select Paste.

Printing a Graph

To check how the graph looks on a printed page, select Print Preview from the File menu.

To print the graph, click the Print icon  on the PAS toolbar, select a printer and click OK.

7.5.3 Viewing the Event Log

The event log records timestamped events associated with configuration changes, resets, device diagnostics, and logic controller operations.

The event log is displayed in a tabular form, one event per line. Use the scroll bar to view all log contents.

Filtering and Sorting Events

You can use filtering to find and work with a subset of events that match the criteria you specify.

Click the Filter icon  on the window toolbar, or right-click on the window and select “Filter...”. Check the causes of the events you want to display and click OK. PAS temporarily hides rows that you do not want to display.

To change the default sort order based on date and time, click the Sort icon  on the window toolbar, or right-click on the window and select “Sort...”, check your preferred sort order, and click OK.

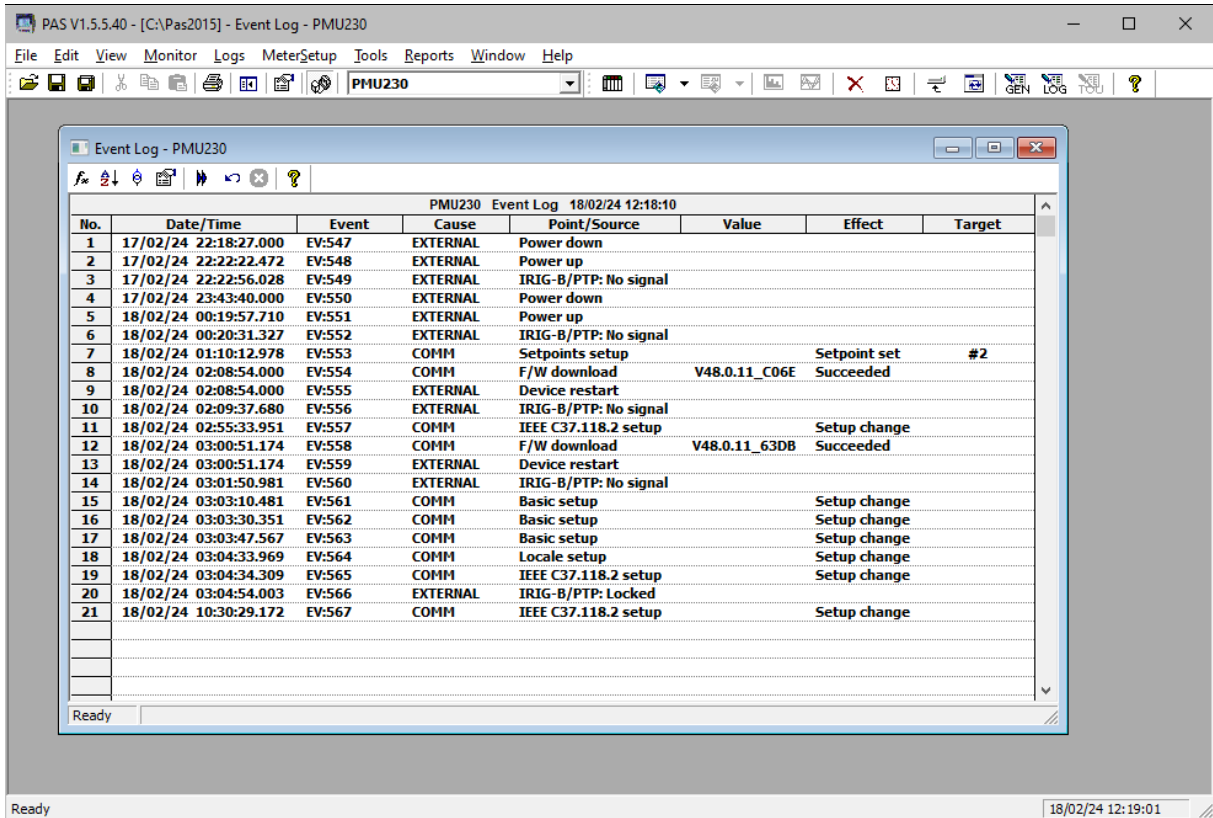

7.5.4 Viewing the Data Log

Data log files can be displayed in tabular form, one data record per row, or in a graphical view in the form of a data trend graph.

Click the Data Trend icon  on the window toolbar to view data in graphical form.

See 7.5.2 “Viewing Options” for information about the options available in the table and graph windows.

An example of the data log view is shown in the following picture.

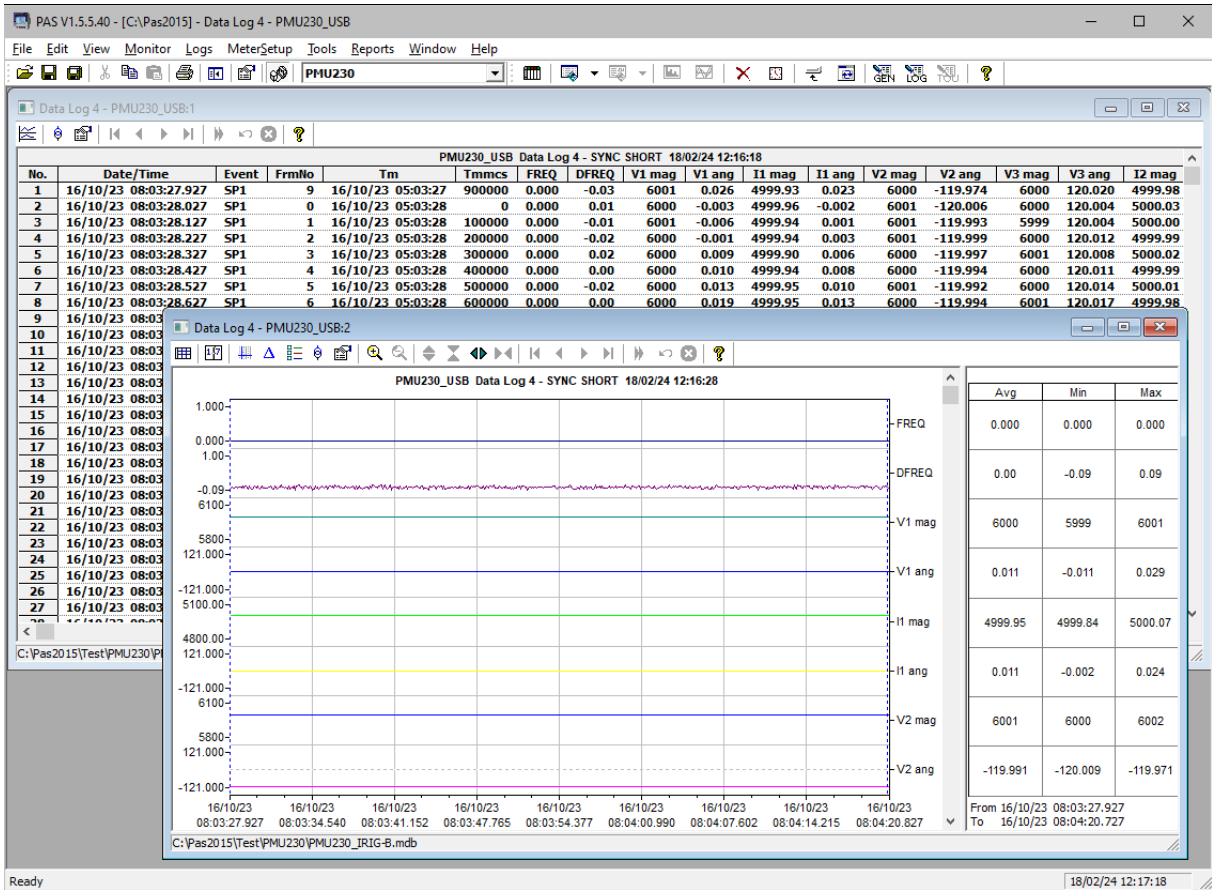

Appendix A Technical Specifications

Environmental Conditions

Operating temperature: -25°C to 55°C (-13°F to 131°F)

Limited (no hardware failure) operating temperature: -40°C to 70°C (-40°F to 158°F)

Limited (no display failure) operating temperature: -20°C to 70°C (-4°F to 158°F)

Storage temperature: -30°C to 85°C (-22°F to 185°F)

Humidity: 0 to 95% non-condensing

Altitude: up to 2000 m (6561 ft) above sea level

Degree of protection: IP51

Construction

Dimensions (without expansion modules): 89.5 x 90 x 72 mm

Weight: 0.70 kg (1.54 lb.)

Materials

Case enclosure: plastic PC/ABS blend

Front panel: plastic PC

PCB: FR4 (UL94-V0)

Terminals: PBT (UL94-V0)

Connectors, plug-in type: Polyamide PA6.6 (UL94-V0)

Packaging case: Carton and Stratocell® (Polyethylene Foam) brackets

Labels: Polyester film (UL94-V0)

Power Supply

Overvoltage category: Category III

Rated input: 100-277VAC 50/60 Hz, 40-290VDC, Burden 11VA

Isolation: input to ground 4000 VAC 1 min

Wire size: up to 10 AWG (4.5 mm²)

Connector type: 2 pins, plug-in

Voltage Input Ratings

Measurement category: CAT III

Operating range: 277/480 VAC +25%

Input impedance: 4000 kΩ

Burden: < 0.04 VA @ 400V, < 0.01 VA @ 120V

Over-voltage withstands: 1000 VAC continuous, 2000 VAC for 1 second

Isolation: 4000 VAC 1 min

Wire size: up to 10 AWG (4.5 mm²)

Connector type: 4 pins, plug-in

Current Inputs Ratings

Measurement category: CAT III

Galvanic isolation: 4000 VAC 1 min

Wire size: up to 10 AWG (4.5 mm²)

5A secondary

Operating range: continuous 10A RMS

Burden: < 0.2 VA @ 5 A (with 10 AWG wire and 1 m long)

Overload withstand: 15A RMS continuous, 200A RMS for 1/2 second (with 10 AWG section wire)

1A secondary

Operating range: continuous 2A RMS

Burden: < 0.2 VA @ 1 A (with 10 AWG wire and 1 m long)

Overload withstand: 3A RMS continuous, 40A RMS for 1/2 second (with 10 AWG section wire)

Built-in Analog Input

Ranges: ±1 mA (x2 overload), 0-1 mA (x2 overload), 0-20 mA, 4-20 mA

Accuracy: 1%

Update time: at PMU data rate

Galvanic isolation: 4000VAC 1 min

Wire size: 14 AWG (up to 1.5 mm²)

Connector type: plug-in

Built-in Relay Output

One solid-state relay rated at 100 mA/250 VAC/VDC, 1 contact (SPST Form A)

Galvanic isolation: 5000VAC 1 min

Wire size: 14 AWG (up to 1.5 mm²)

Connector type: 2 pins, plug-in

Turn-on time: 5 ms max

Turn-off time: 5 ms max

Update time: 1/2 cycle

Expansion Relay Outputs

Electromechanical Relays

4 or 2 dry-contact electromechanical relays rated at 5A/250 VAC, 5A/30 VDC, 1 contact (SPST Form A)

Galvanic isolation: between contacts and coil 3000 VAC 1 min, between open contacts 750 VAC

Wire size: 14 AWG (up to 1.5 mm²)

Connector type: plug-in

Operate time: 10 ms max

Release time: 5 ms max

Update time: 1 cycle

Solid-state Relays

4 or 2 solid-state relays rated at 100 mA/250 VAC/VDC, 1 contact (SPST Form A)

Galvanic isolation: 5000VAC 1 min

Wire size: 14 AWG (up to 1.5 mm²)

Connector type: plug-in

Turn-on time: 5 ms max

Turn-off time: 5 ms max

Update time: 1/2 cycle

Built-in Digital Input

One dry-contact internally powered digital input

Sensitivity: open @ input resistance >100 k Ω , closed @ input resistance < 100 Ω

Galvanic isolation: 4000 VAC 1 min

Internal power supply: 24VDC

Wire size: 14 AWG (up to 1.5 mm²)

Connector type: 2 pins, plug-in

Update time: 1 ms

Expansion Digital Inputs

Dry-contact

4 or 8 dry-contact internally powered digital inputs

Sensitivity: open @ input resistance >100 k Ω , closed @ input resistance < 100 Ω

Galvanic isolation: 4000 VAC 1 min

Internal power supply: 24 VDC

Wire size: 14 AWG (up to 1.5 mm²)

Connector type: plug-in

Update time: 1 ms

Wet-contact

4 or 8 wet-contact digital inputs

Galvanic isolation: 4000 VAC 1 min

External power supply: 250 VDC

Wire size: 14 AWG (up to 1.5 mm²)

Connector type: plug-in

Update time: 1 ms

COM1 RS-485 Communication Port

RS-485 optically isolated port

Isolation: 4000 VAC 1 min

Baud rate: 2400 to 115200 bps.

Supported protocols: Modbus RTU, Modbus ASCII, DNP3, IEC 60870-5-101.

Connector type: 2 pins, plug-in

Wire size: up to 14 AWG (up to 1.5 mm²).

Ethernet Ports

2 transformer-isolated 10/100BaseT Ethernet ports

Isolation: 4000 VAC 1 min

Connector type: RJ-45

Supported protocols: Modbus/TCP, DNP3/TCP, IEC 60870-5-104, IEC 61850, IEEE C37.118.2, IEEE 1588 PTP

USB Port

Full speed USB 2.0 port

Isolation: 4000 VAC 1 min

Connector type: USB Type C

Supported protocols: Modbus/TCP

IRIG-B Port

Optically isolated IRIG-B port

Timecode signal: unmodulated (pulse-width coded), 100 pps

Signal level: unbalanced 5V

Timecode format: B004/B005

Isolation: 4000 VAC 1 min

Connector type: plug-in

Recommended cable: 510 Ω m low loss RG58A/U (Belden 8219 or equivalent)

Real-time Clock

Built-in real-time clock with battery backup

Accuracy, calibrated: < 5 ppm at 23°C

Battery type: CR1632 3V Lithium coin battery

Time retention: 5 years (typical)

Display

1.77" color TFT LCD display

Resolution: 128 x 160 pixels

2 diagnostic LEDs

Keypad: 4 push buttons

Standards Compliance

Accuracy:

IEEE C37.118.1, IEEE C37.118.1a and IEC/IEEE 60255-118-1 P and M performance classes

Electromagnetic Immunity:

Comply with IEC 61000-6-2:

IEC 61000-4-2 level 3: Electrostatic Discharge

IEC 61000-4-3 level 3: Radiated Electromagnetic RF Fields

IEC 61000-4-4 level 3: Electric Fast Transient

IEC 61000-4-5 level 3: Surge

IEC 61000-4-6 level 3: Conducted Radio Frequency

IEC 61000-4-8: Power Frequency Magnetic Field

Meets ANSI/IEEE C37.90.1: Fast Transient SWC

Electromagnetic Emission:

Comply with IEC 61000-6-4: Radiated/Conducted class A

Comply with IEC CISPR 22: Radiated/Conducted class A

Safety:

Meets IEC 61010-1: 2006

UL listed File No. E472110

UL listing covers the base unit, the optional modules are not a part of UL listing

AC and Impulse Insulation:

Meets IEC 62052-11: 4000VAC during 1 minute, 6KV/500 Ω @ 1.2/50 μ s impulse

Degree of protection: IP51

Appendix B Measurement Specifications

Input ratings

Inputs	Parameter	Value
Voltage	Rated voltage	57.7/100–69.3/120 VAC or 220/380–277/480 VAC (upon order)
	Measurement range	1-277/480 VAC +25%
Current	Rated current	1 A or 5 A (upon order)
	Measurement range	0.1-200% rated current

Measured frequency range

Performance class	Nominal frequency	Data reporting rate (Fs), frames/s	Frequency range
P	50 Hz	1, 2, 5, 10, 25, 50, 100, 200	50 ±2 Hz
	60 Hz	1, 2, 3, 4, 5, 6, 10, 12, 15, 20, 30, 60, 120, 240	60 ±2 Hz
M	50 Hz	1, 2, 5, 10	50 ±2 Hz
		25, 50, 100, 200	50 ±5 Hz
	60 Hz	1, 2, 3, 4, 5, 6, 10	60 ±2 Hz
		12	60 ±2.4 Hz
		15	60 ±3 Hz
		20	60 ±4 Hz
30, 60, 120, 240	60 ±5 Hz		

P class accuracy, under steady-state conditions (57.7/100 VAC, 80% to 120% rated voltage, 10% to 200% rated current, at 23° C)

Parameter	Conditions	Value
Frequency	Over frequency range	< 0.0005 Hz (typical)
	Over temperature range 0-50 °C	0.001 Hz
TVE, voltage	At nominal frequency	0.05%
	Over frequency range	0.1%
	Over temperature range 0-50 °C	0.2%
TVE, current	At nominal frequency, > 40% rated current	0.05%
	Over frequency range	0.1%
	Over temperature range 0-50 °C	0.2%
Phase	At nominal frequency	0.025 degree
	Over frequency range	0.05 degree
	Over temperature range 0-50 °C	0.1 degree

M class accuracy, under steady-state conditions (57.7/100 VAC, 10% to 120% rated voltage, 10% to 200% rated current, at 23° C)

Parameter	Conditions	Value
Frequency	At nominal frequency, > 40% rated voltage	< 0.0005 Hz (typical)
	Over frequency range	0.001 Hz
	Over temperature range 0-50 °C	0.001 Hz
TVE, voltage	At nominal frequency, > 60%/50Hz, > 40%/60Hz rated voltage	0.05%
	Over frequency range	0.1%
	Over temperature range 0-50 °C	0.2%
TVE, current	At nominal frequency, > 40% rated current	0.05%
	Over frequency range	0.1%
	Over temperature range 0-50 °C	0.2%
Phase	At nominal frequency	0.025 degree
	Over frequency range	0.05 degree
	Over temperature range 0-50 °C	0.1 degree

Appendix C Measured Parameters

The following table lists parameters measured by the device and available for monitoring through communications and as triggers for operating the logic controller. The left column shows data abbreviations used in PAS. Parameter groups are highlighted in bold.

All electrical quantities are fundamental components and are based on voltage and current synchrophasor measurements. Real-time measurements are synchronized with the PMU data rate. Average measurements are one-second average values updated at the UTC second rollover.

Complex synchrophasor values are given in both polar and rectangular forms.

Measured Parameters

Designation	Description
NONE	None (read as zero)
SETPOINTS	Setpoint status
SP1:32	Setpoint SP1-SP32 status
EVENT FLAGS	Event flags status
EVENT FLAG 1:32	Event flag 1-32 status
TIMERS	Periodic timers (trigger only)
TIMER 1:16	Timer 1-16 transition (free-running)
DIGITAL INPUTS	Digital inputs
DI1:25	Digital input DI1-DI25 status
PULSE INPUTS	Pulse inputs (trigger only)
DI1:25	Digital input DI1-DI25 transition
RELAYS	Relay status
RO1:13	Relay RO1-RO13 status
COUNTERS	General counters
COUNTER 1-32	General counter 1-32 value
TIME	Time and date
DAY OF WEEK	Day of week
YEAR	Year
MONTH	Month
DAY OF WEEK	Day of month
HOURS	Hours
MINUTES	Minutes
SECONDS	Seconds
MINUTE INTERVAL	Interval timer synced with clock (1-5, 10, 15, 20, 30, 60 min)
TmStamp	Timestamp, UTC seconds since 1/1/1970
TmStampMcs	Timestamp, fraction of second
RT PHASE	Real-time fundamental phase measurements
V1	V1 voltage
V2	V2 voltage
V3	V3 voltage
I1	I1 current

Designation	Description
I2	I2 current
I3	I3 current
kW L1	kW L1
kW L2	kW L2
kW L3	kW L3
kvar L1	kvar L1
kvar L2	kvar L2
kvar L3	kvar L3
kVA L1	kVA L1
kVA L2	kVA L2
kVA L3	kVA L3
PF L1	Displacement power factor L1
PF L2	Displacement power factor L2
PF L3	Displacement power factor L3
V12	V12 voltage
V23	V23 voltage
V31	V31 voltage
RT TOTAL	Real-time fundamental total values
kW	Total kW
kvar	Total kvar
kVA	Total kVA
PF	Total displacement power factor
RT AUX	Real-time auxiliary measurements
In	In (neutral) current
FREQ	Frequency, 2 decimals
V UNB%	Voltage unbalance
I UNB%	Current unbalance
FREQ3	Frequency, 3 decimals
AVR PHASE	Average fundamental phase values
V1	V1 voltage
V2	V2 voltage
V3	V3 voltage
I1	I1 current
I2	I2 current
I3	I3 current
kW L1	kW L1
kW L2	kW L2
kW L3	kW L3
kvar L1	kvar L1
kvar L2	kvar L2
kvar L3	kvar L3
kVA L1	kVA L1
kVA L2	kVA L2
kVA L3	kVA L3
PF L1	Displacement power factor L1

Designation	Description
PF L2	Displacement power factor L2
PF L3	Displacement power factor L3
V12	V12 voltage
V23	V23 voltage
V31	V31 voltage
AVR TOTAL	Average fundamental total values
kW	Total kW
kvar	Total kvar
kVA	Total kVA
PF	Total displacement power factor
AVR AUX	Average auxiliary measurements
In	In (neutral) current
FREQ	Frequency, 2 decimals
V UNB%	Voltage unbalance
I UNB%	Current unbalance
IntTemp	Internal temperature
FREQ3	Frequency, 3 decimals
Vbatt	Lithium battery voltage
PHASORS	Real-time phasors (synchrophasor alias)
V1 Mag	V1 voltage magnitude
V2 Mag	V2 voltage magnitude
V3 Mag	V3 voltage magnitude
I1 Mag	I1 current magnitude
I2 Mag	I2 current magnitude
I3 Mag	I3 current magnitude
V1 Ang	V1 voltage angle
V2 Ang	V2 voltage angle
V3 Ang	V3 voltage angle
I1 Ang	I1 current angle
I2 Ang	I2 current angle
I3 Ang	I3 current angle
SYMM COMP	Real-time symmetrical (sequence) components
V PSEQ	Positive sequence voltage
V NSEQ	Negative sequence voltage
V ZSEQ	Zero sequence voltage
V NSEQ UNB%	Negative sequence voltage unbalance
V ZSEQ UNB%	Zero sequence voltage unbalance
I PSEQ	Positive sequence current
I NSEQ	Negative sequence current
I ZSEQ	Zero sequence current
I NSEQ UNB%	Negative sequence current unbalance
I ZSEQ UNB%	Zero sequence current unbalance
V0seq	Zero sequence voltage (alias)
V1seq	Positive sequence voltage (alias)
V2seq	Negative sequence voltage (alias)

Designation	Description
I0seq	Zero sequence current (alias)
I1seq	Positive sequence current (alias)
I2seq	Negative sequence current (alias)
AI (1 cycle)	Real-time analog inputs
AI1	Analog input AI1
AI (1 sec)	Average analog inputs
AI1	Analog input AI1
AI RAW	Real-time raw analog inputs
AI1	Analog input AI1
Synchrophasor	Synchrophasor measurements
FrmNo	Frame number
Tm	Frame timestamp, UTC seconds since 1/1/1970
Tmmcs	Frame timestamp, fraction of second
TmQual	Time quality, bitmap (see below)
IDCode	Data source/stream ID number
Stat	Frame status, bitmap (see below)
FREQ	Frequency deviation from nominal or actual frequency, Hz
DFREQ	Rate of change of frequency (ROCOF), Hz/s
V1 Mag	V1 phasor magnitude
V1 Ang	V1 phasor angle
V2 Mag	V2 phasor magnitude
V2 Ang	V2 phasor angle
V3 Mag	V3 phasor magnitude
V3 Ang	V3 phasor angle
I1 Mag	I1 phasor magnitude
I1 Ang	I1 phasor angle
I2 Mag	I2 phasor magnitude
I2 Ang	I2 phasor angle
I3 Mag	I3 phasor magnitude
I3 Ang	I3 phasor angle
V1 Re	V1 phasor, Real
V1 Im	V1 phasor, Imaginary
V2 Re	V2 phasor, Real
V2 Im	V2 phasor, Imaginary
V3 Re	V3 phasor, Real
V3 Im	V3 phasor, Imaginary
I1 Re	I1 phasor, Real
I1 Im	I1 phasor, Imaginary
I2 Re	I2 phasor, Real
I2 Im	I2 phasor, Imaginary
I3 Re	I3 phasor, Real
I3 Im	I3 phasor, Imaginary
V1seq mag	Positive sequence voltage phasor magnitude
V1seq ang	Positive sequence voltage phasor angle
I1seq mag	Positive sequence current phasor magnitude

Designation	Description
I1seq ang	Positive sequence current phasor angle
V1seq Re	Positive sequence voltage phasor, Real
V1seq Im	Positive sequence voltage phasor, Imaginary
I1seq Re	Positive sequence current phasor, Real
I1seq Im	Positive sequence current phasor, Imaginary
V2seq mag	Negative sequence voltage phasor magnitude
V2seq ang	Negative sequence voltage phasor angle
I2seq mag	Negative sequence current phasor magnitude
I2seq ang	Negative sequence current phasor angle
V2seq Re	Negative sequence voltage phasor, Real
V2seq Im	Negative sequence voltage phasor, Imaginary
I2seq Re	Negative sequence current phasor, Real
I2seq Im	Negative sequence current phasor, Imaginary

PMU time quality

Bits	Description
0:3	0xF = clock failure, time not reliable 0xB = time within 10 s 0xA = time within 1 s 0x9 = time within 100 ms 0x8 = time within 10 ms 0x7 = time within 1 ms 0x6 = time within 100 μs 0x5 = time within 10 μs 0x4 = time within 1 μs 0x3 = time within 100 ns 0x2 = time within 10 ns 0x1 = time within 1 ns 0x0 = locked to UTC traceable source
4	Leap second pending
5	Leap second occurred
6	Leap second direction, 0 = add, 1=delete

PMU frame status

Bits	Description
0:3	Trigger reason
4:5	Unlocked time: 0 = sync locked or unlocked time < 10 s (best quality) 1 = unlocked time < 100 s 2 = unlocked time <= 1000 s 3 = unlocked time > 1000 s
6:8	PMU time quality: 1 = maximum time error < 100 ns 2 = maximum time error < 1 μ s 3 = maximum time error < 10 μ s 4 = maximum time error < 100 μ s 5 = maximum time error < 1 ms 6 = maximum time error < 10 ms 7 = maximum time error > 10 ms or time error unknown
9	1 = data modified by post processing, 0 = otherwise
10	Configuration change, set to 1 for 1 min to advise configuration will change, and cleared to 0 when change effected
11	1 = PMU trigger detected, 0 = no trigger
12	Data sorting, 0 = by timestamp, 1 = by arrival
13	0 = PMU in sync with a UTC traceable time source
14-15	Data error: 0 = good measurement data 1 = PMU error (no information about data) 2 = PMU in test mode or absent data tags inserted (do not use values) 3 = PMU error (do not use values)

Appendix D Data Scales

The maximum values for volts, amps and power in the PMU setup and in communications are limited by the voltage and current scale settings. See 5.2.1 “Basic Setup” for how to change voltage and current scales in your device.

The following table shows the device data scales.

Scale	Range
Maximum voltage, V_{max}	Voltage scale \times PT Ratio, V ¹
Maximum current, I_{max}	Current scale \times CT Ratio, A ^{2,3}
Maximum power, P_{max} ⁴	$V_{max} \times I_{max} \times 2$, W

1 The default voltage scale is 144V (120V+20%)

2 CT Ratio = CT primary current/CT secondary current

3 The default current scale is $2 \times$ CT secondary (10 A with 5A secondary).

4 Maximum power is rounded to whole kilowatts.

Appendix E Diagnostic Messages

Diagnostic Code	Description	Reason
1	Permanent Fault	Hardware failure
2	RAM/Data error	Hardware failure
3	HW Watchdog Reset	Hardware failure
4	DSP/Sampling Fault	Hardware failure
5	CPU Exception	Hardware failure
6	Run-time Error	Hardware failure
7	SW Watchdog Reset	Hardware failure
8	Power Down	Loss of power
9	Device reset	External restart via communications or in case of firmware upgrade
10	Configuration Reset	Corrupted setup data has been replaced with the default configuration
11	RTC Fault	The clock time has been lost. With auto-reset: cleared automatically once the clock is updated.
12	Configuration Fault	Factory, calibration or basic device configuration data has been corrupted
13	Battery Low	Low lithium battery. With auto-reset. Battery check or replacement is required.
14	Expanded Memory Fault	Hardware failure
15	CPU EEPROM Fault	Hardware failure
20	Library error	Hardware failure
22	Task Error	Hardware failure
24	IRIG-B/PTP: No Signal	The device has lost a signal from a UTC time source
25	IRIG-B/PTP: Time Unlocked	The UTC time source previously synchronized to a GPS primary reference is now free-running (holdover mode) based on its own internal oscillator

Troubleshooting Device Issues

In the event of a device fault, check the cause of the malfunction and clear the device diagnostics. For instructions, see 6.5 “Viewing and Clearing Device Diagnostics”.

If the device time is out of order, update the device clock. In the event of a configuration reset, check the affected settings through the device Event log, and then verify the setup data.

Hardware failures are normally non-critical recoverable faults that do not cause system failure but may result in data loss. Hardware failures are often caused by excessive electrical noise in the area of the device. If the device continues to reset, contact your local distributor.